

ROBOTICS MICROCONTROLLERS COMPUTER CONTROL SPACE

Everything For Electronics

Nuts & Volts

April 2005

www.nutsvolts.com

THE SOLAR ALTERNATIVE

*Using Solar Cells on Small
Projects is a Bright Idea!*



ALSO INSIDE:

- ★ **Wireless Control for Any PIC Project**
- ★ **Add Text Over Video the Easy Way**
- ★ **Build a Universal Relay Board**
- ★ **Construct a Pulse Generator**

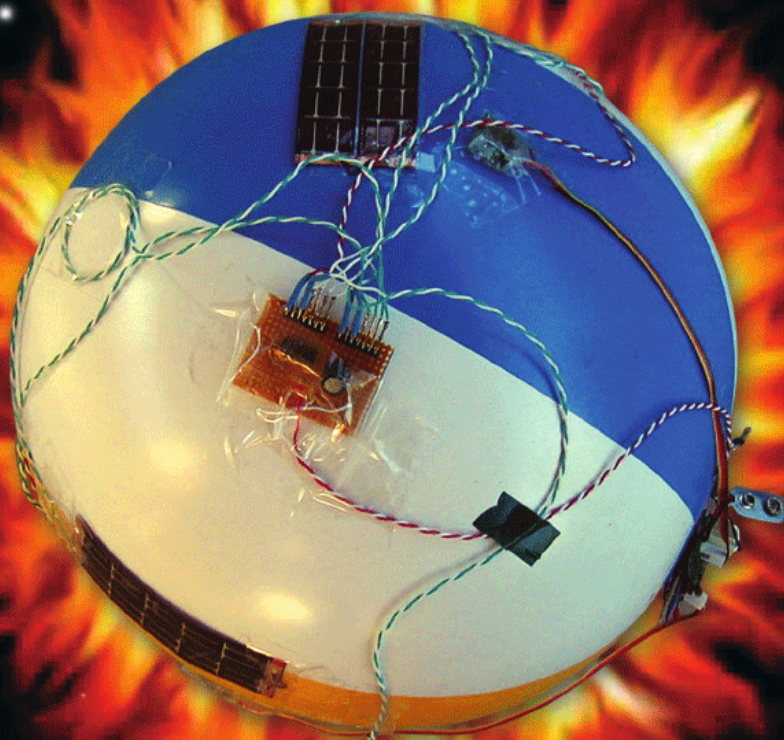

U.S. \$5.50 CANADA \$9.25



**ANYTHING THEY CAN DO...
WE DO...**

**BASICX24™
\$49.95 (QTY 1)**

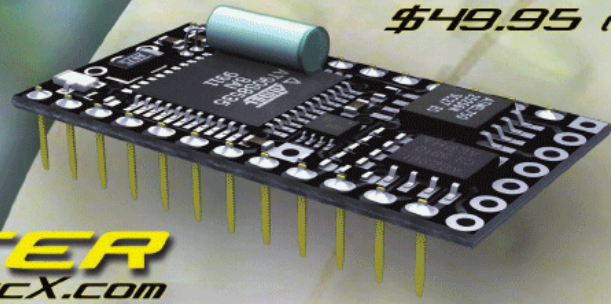

...FASTER
www.BASICX.COM

Executing 65,000 lines of Basic code per second the BasicX-24 is the KING of Basic programmable microcontrollers.

400 bytes RAM.
32K User program area.
19 I/O lines with 8 10Bit ADC's.
Real multitasking and Serial UARTs.

...SMALLER
www.SITEPLAYER.COM

Siteplayer is a true stand-alone mini web server.

Super easy to use.
Standard RJ-45 network interface.
Control or monitor anything over the web.

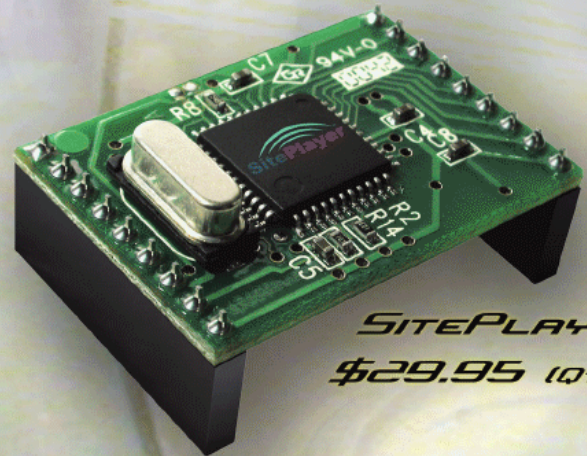

**SITEPLAYER™
\$29.95 (QTY 1)**

**2x16 SERIALLCD™
\$39.95 (QTY 1)**

...BETTER
www.BASICX.COM

High quality serial 2x16 LCD with backlight

Easy to use.
2400 & 9600 Baud support
Software controllable backlight and contrast.

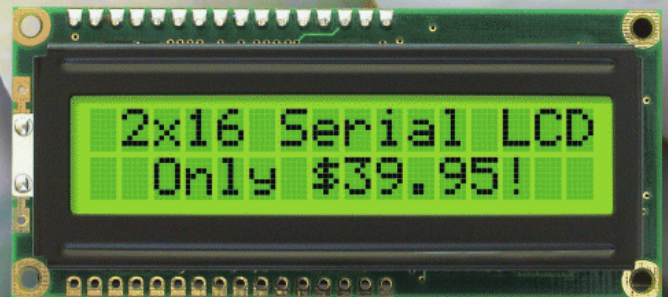

Circle #34 on the Reader Service Card.

NetMedia

NETMEDIA INC. 10940 NORTH STALLARD PLACE TUCSON ARIZONA 85737
www.NETMEDIA.COM 520.544.4567

USB - IDE Adaptor!

- ◆ USB 2.0 to IDE Drive Adapter cable, 2.5'
- ◆ Bridge between USB port and one ATA- or ATAPI-based mass storage device.
- ◆ Makes any IDE device an external drive!
- ◆ External power adapter for IDE devices
- ◆ Transfer rate Approx. 480 MBps
- ◆ New, 90-day warr. - Includes driver CD

HSC#80767 \$24.50!

DVI Cable Deal!

- ◆ DVI-I Digital & Analog, Single-link cable
- ◆ Male-to-Male
- ◆ Black, 8 ft. long
- ◆ Super price!
- ◆ New in bag
- ◆ HSC 90-day warr.



HSC#20346 \$9.95

Hobbyist Alert -- Fans on the Web!

Here is a sample of the way our website is growing...have a look at just some of the fans we offer! More are available than can be listed here! From time to time, we will show you some of our vast inventory here in this ad, but if you want to see more, go to www.halted.com for the full story...we are uploading all the time!

FAN 110-120VAC .15A 18W 7-BLADE METAL	20292	\$9.95
FAN 110-120VAC 12W MAX 80X38MM 5-BLADE	20291	\$10.95
FAN 110/120VAC 15/13W 93X25MM 5-BLADE	19624	\$10.50
FAN 115VAC 120X38MM 5-BLADE	80156	\$13.95
FAN 115VAC 15/13W 1 PHASE 4-1/2 5-BLADE	20206	\$14.95
FAN 115VAC 18/17A 118X38MM 5-BLADE	20285	\$14.95
FAN 208/240VAC 60/55MA 10/9W 120X40MM	16766	\$14.95
FAN 220VAC 11W 3-1/8" OPEN FRAME	464	\$6.95
FAN 220VAC 11W 60HZ 5-BLADE OPEN FRAME	17158	\$4.95
FAN 230VAC 19W 120X38MM	17672	\$14.95
FAN 230VAC 120MM 3-BLADE	20163	\$14.95
FAN 240V/208VAC 12W 60HZ 80X40MM 5-BLADE	16140	\$9.95
FAN 5VDC .6W 40X40X10MM 5-BLADE	18935	\$5.25
FAN 5VDC .14A 35X7MM LAPTOP COOLR 7-BLADE	80695	\$4.95
FAN 5VDC .27A 60X60X25MM 7-BLADE BALLBRG	19162	\$5.95
FAN 5VDC .2A 30X12MM 7-BLADE BRUSHLESS	19222	\$4.95
FAN 5VDC 50MM BRUSHLESS	20166	\$5.25
FAN 12VDC .06A 45X10MM 9-BLADE	19699	\$5.25
FAN 12VDC .06A 80X25MM 7-BLADE MINI TOWER	20286	\$7.95
FAN 12VDC .07A LOW PROFILE	19532	\$3.95
FAN 12VDC .09A 60X15MM 9-BLADE BRUSHLESS	19657	\$5.95
FAN 12VDC .11A 60X25MM 7-BLADE BRUSHLESS	19927	\$5.95
FAN 12VDC .15A 92X25MM 7-BLADE BALL BRG.	19811	\$7.25
FAN 12VDC .16A 92X25MM 7-BLADE	20289	\$7.25
FAN 12VDC .17A 60X13MM	18759	\$5.95
FAN 12VDC .20A W/PC PWR CABLE	20218	\$7.95
FAN 12VDC .26A 60X25MM 7-BLADE BRUSHLESS	20293	\$6.95
FAN 12VDC .5A 120X38MM METAL 5-BLADE	20288	\$8.95
FAN 12VDC .85A BLOWER BRUSHLESS	20272	\$12.50
FAN 12VDC 0.15A 50MM BRUSHLESS	20258	\$4.95
FAN 12VDC 0.17A 60MM BRUSHLESS	20259	\$4.95
FAN 12VDC 1.3A 16W 125X38MM	19421	\$9.95
FAN 12VDC 120X38MM 3-BLADE	19226	\$7.95
FAN 12VDC 5.1W 120X38MM 5-BLADE PLASTIC	20287	\$7.95
FAN 12VDC 580MA 120X25MM 7-BLADE	19991	\$7.95
FAN 12VDC 70MA 40X20MM 7-BLADE	19929	\$5.25
FAN 12VDC ASSORTED PENTIUM CPU COOLER	17912	\$2.95
FAN 24VDC .14A 90X25MM 7-BLADE METAL	9669	\$7.25
FAN 24VDC 1.7 AMP 6-3/4" 5-BLADE	20156	\$14.95
FAN 24VDC .08A 40X15MM 7-BLADE	19928	\$5.25
FAN 24VDC .3A 92X25MM 7-BLADE BALL BRG.	19837	\$7.25
FAN 24VDC 0.11A PANAFLO BRUSHLESS	92683	\$4.95
FAN 24VDC 120X39MM W/GRILL	17173	\$7.95
FAN 48VDC .45A 170X50MM 5-BLADE	15970	\$9.95
FAN 48VDC .75A 120X38MM 9-BLADE 190CFM	19867	\$7.95

Outstanding Outlets, Fantastic Fans!

- ◆ Outlet strips for your bench or 19" racks!
- ◆ TrippLite PS4816-NS has 16 outlets
- ◆ 48" long, circuit-breaker protected
- ◆ Rated 15A, 6 foot cord, regular AC plug
- ◆ New in box, HSC 90-day warranty

HSC#20485 \$35.00

- ◆ Brooks Power Systems APS 48-10-65
- ◆ 48" long, circuit-breaker protected
- ◆ Rated 20A, 5 duplex outlets, 6 foot cord
- ◆ Special AC Plug has one horizontal blade
- ◆ New in box, HSC 90-day warranty

HSC#20486 \$35.00

- ◆ New 19" rack-mountable dual fan ass'y
- ◆ Two 6" fans, 120 VAC, with grille
- ◆ See all the above on our website!

HSC#20484 \$39.50

Wireless Video System!

- ◆ Tiny 3/4 in. color camera w/transmitter!
- ◆ Receiver is tuneable for best signal
- ◆ 9VDC batt. conn. for portable camera
- ◆ AC power packs for both units!
- ◆ RCA plugs for A/V out,
- ◆ 'F' conn for whip.
- ◆ New, 90-day warranty



HSC#80748 \$59.95!

Parallel Port External Hard Drive

- ◆ 'H45' "QuickDrive"
- ◆ For 3.5" IDE drive type
- ◆ Special shock mount
- ◆ For DOS & W95+



HSC#19976 \$19.95

CompactPCI® Enclosure Package!

- ◆ CG Mupac's '535 Series'
- ◆ 19" rackmountable 9U cabinet
- ◆ 3-350W hot-swappable front-pull power supplies
- ◆ 21-slot 6U x 160mm front & 6U x 80mm rear IEEE1101.10/1101.11 Compliant CompactPCI subracks
- ◆ Hot-pluggable fan tray w/2 141 CFM top-mntd blowers, bottom blowers also
- ◆ Two front-pull drawers for SCA-type SCSI hard disk drives
- ◆ **Bonus!** 'Force' "X86" plug-in included at **no extra charge!!** Complete 'X86' computer, 233 MHz, w/VGA, PIO, SIO, USB, 10BaseT and floppy disk drive!!
- ◆ Unused - removed from installation

HSC#20249 \$295.00

System Accessories

- ◆ Force CPCI-680 CPU, 450MHz, 128MB
- ◆ Fast/Wide SCSI, Linux compatible
- ◆ Universal Mode PCI-PCI Bridge

HSC# 20426 \$195.00

- ◆ Extra plug in 350W switching power supply, incl. CPCI-3500-P-38

HSC# 20250 \$125.00

HSC Exclusive -- Pixie2!

- ◆ Tiny QRP Xcvr rig! 200-300 mW out
- ◆ Kit incl. all board-mounted parts
- ◆ Use 'walkman' phones
- ◆ **GRP crystal pack special!** Finally!!...80, 40, 30, 20, 17, 15 & 10 meter calling freqs. in one bag!



HSC#crystalpak \$14.95

HSC#Pixie2 \$9.95

IDE Case for USB!

- ◆ Supports 2.5-inch IDE drives up to 14mm
- ◆ Up to 480 Mbps data transfer rate, no max. Hard Drive RPM
- ◆ Hot-Swappable Plugand Play
- ◆ Complies with ATA/ATAPI-6 Standards
- ◆ Software, USB Cable, User's guide included



HSC#80772 \$15.95

Ultrasonic Range Sensor

- ◆ Similar to SonaSwitch 'Mini-S'
- ◆ Mounts in 1.575" hole!!
- ◆ Fixed range: 5-7 feet.
- ◆ Rep. sense rate: 10Hz
- ◆ See <http://www.halted.com> for tech info
- ◆ HSC 90-day warranty



HSC#19833 \$9.95

Special Bargains!!

Dot Matrix Display #19429 \$8.00	Laptop Floppy Drive HSC#20180 \$14.95	12VDC Adapt., 3.4A HSC#19312 \$9.95	Cordless USB Adap #19738 \$6.00!
Neon Light for PC, Sound Activated! #20441 \$9.95	33.6k Socket Modem HSC#20217 \$4.95!	Wearable Mini-Phonel #20244 \$9.95	80W Power Supply #18415 \$5.00
VideoWAVE Editor #19656 \$9.95!	Cordless LAN Card #19737 \$6.00!	2 X 24 Char LCD #20356 \$7.50	150W Power Supply #19266 \$8.00
2-Button Serial Microsoft Mouse #18731 \$3.95	'Mylex' RAID Card New Price! #19427 \$15.00!	LCD Dot Matrix Display 2 x 40 char. Sharp #20298 \$9.50	200W Power Supply #19267 \$10.00

You can get more info about any of these items on our website!



3 Retail/Wholesale Locations:
Main Office - Mail Orders...
3500 Ryder St. Santa Clara, CA 95051
Santa Clara 1-408-732-1573
Sacramento 1-916-338-2545
Rohnert Park 1-707-585-7344

Silicon Valley's Electronic Marketplace

Look for us on...

seller ID: hscelectronicsupply

Order Toll-Free: 1-800-4-HALTED(442-5833)
or...ONLINE, AT: www.halted.com

Terms: Some quantities limited; all items are subject to prior sale. Minimum order: \$10.00 plus shipping. Orders under \$30.00 subject to \$3.00 handling fee, in addition to shipping. All orders shipped by UPS Surface unless otherwise specified. \$6.00 UPS charge added for COD. Visit our website for detailed information on domestic and international shipping methods.

TABLE OF CONTENTS

Vol. 26 No. 4

PROJECTS and FEATURES

38 **MEASURING THE SPEED OF LIGHT**
Clocking the Cosmos for Less Than \$20.00
by Gerard Fonte

46 **BUILDING A PULSE GENERATOR**
Design, Troubleshoot, and Calibrate Electronic Circuits
by Robert Reed

50 **UNIVERSAL RELAY BOARD**
The Applications are Limitless
by Michael Jeffery

62 **PIC Video**
Part I: Video Test Overlay with a PIC Microprocessor
by Robert Lang

69 **SCROUNGING FOR PARTS**
Safety, Rarity, Quality, Wick, Diversity, and Storage
by Daniel Bartlett

72 **THE SOLAR ALTERNATIVE**
Using Solar Cells on Small Projects is a Bright Idea.
by Ralph Lorenz

COLUMNS

8 **OPEN COMMUNICATION**
The Magic of Antennas

16 **TECHKNOWLEDGEY 2005**
Events, Advances, and News from the Electronics World

20 **PERSONAL ROBOTICS**
LEGO My ...

24 **Q&A**
Extending relay contact life, a 20-watt stereo amp, model RR props, and a geography brain teaser

30 **DESIGN CYCLE**
A PIC-based Wi-Fi Development Platform

78 **STAMP APPLICATIONS**
No-contact Access Control Explained

84 **IN THE TRENCHES**
Project Engineering Tasks

APRIL 2005

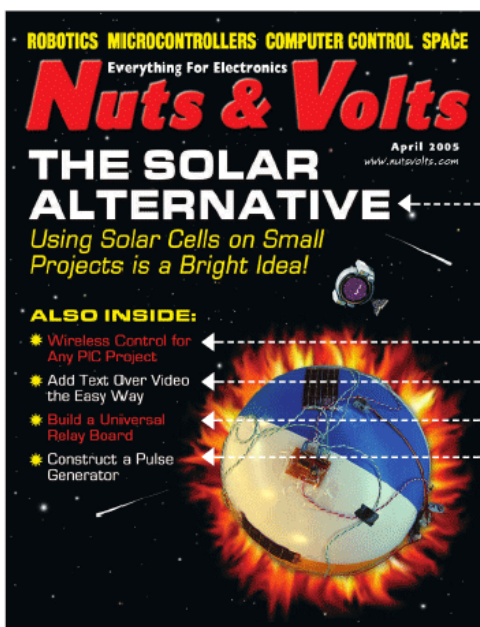

p. **72**

p. **30**

p. **62**

p. **50**

p. **46**

DEPARTMENTS

- 6** Reader Feedback
- 44** Electro-Net
- 56** NV Bookstore
- 59** New Products
- 60** Electronics Showcase
- 90** Classifieds
- 92** News Bytes
- 93** Tech Forum
- 97** Advertiser's Index

Nuts & Volts (ISSN 1528-9885/CDN Pub Agree#40702530) is published monthly for \$24.95 per year by T & L Publications, Inc., 430 Princland Court, Corona, CA 92879. PERIODICALS POSTAGE PAID AT CORONA, CA AND AT ADDITIONAL MAILING OFFICES. POSTMASTER: Send address changes to Nuts & Volts, 430 Princland Court, Corona, CA 92879-1300 or Station A, P.O. Box 54, Windsor ON N9A 6J5; cpcreturns@nutsvolts.com

CIRCUIT BOARD solutions for your robotic needs

Need
FREE
design
software?

FREE
Download the
new version at
www.pcb123.com/nv

PCB¹²³

VERSION
2.0

PCB123 Provides the
Complete Circuit Board Solution,
Design Through Order

- Order up to 100-pcs with Quick Turn Around
- New libraries contain over a 1000 common devices (PIC MCU, AVR, Flash, OTP, EPROM and much more)
- DigiKey, Jameco & Mouser part numbers
- Templates for PC104, PC104+, Rabbit, PCI & more

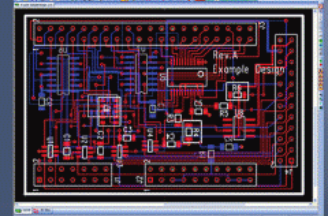
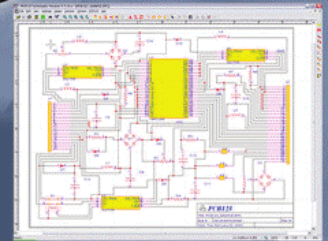

13626 S Freeman Rd. Mulino, OR 97042 USA
Phone: (800) 228-8198 x236 / Fax: (503) 829-6657

DOWNLOAD THE NEW VERSION
www.pcb123.com/nv

Have
design
files?

**YOUR
TARGET**

**FOR PROTOTYPE CIRCUIT
BOARDS**

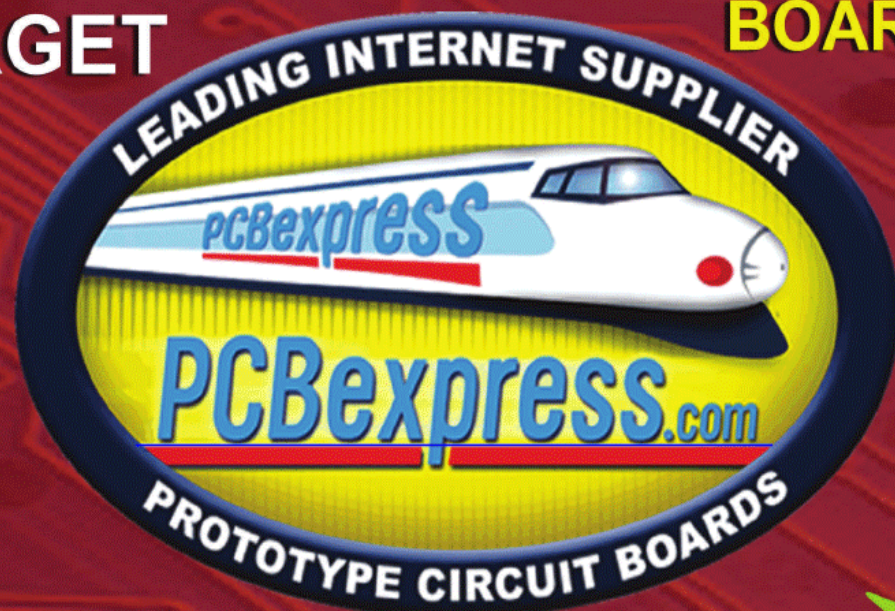

Successfully selling online since 1997.
Experience you can trust! Try us out today at:
www.PCBexpress.com/nv

Enter
the link for
a special
N&V
discount!

No Schematic

As a long-time ham (with more of an inclination to the hardware than the operating) with a taste for QRP, I was delighted by the article in the December 2004 *Nut & Volts* on the Ramsey direct-conversion receiver. Then I looked forward to the February issue with the follow-up article on the Ramsey QRP transmitter.

What a disappointment. It was nothing but an anecdotal description of the building process. Above all, no schematic. That was nothing but an article-length advertisement.

Bob Klahn
Via Internet

Sorry about the omission. Visit <http://ramseykits.com/qrp> for the schematic.

Better Way to Euphoria

Just read Mike Keesling's February article on trying to communicate with the com ports through Basic. I think Euphoria is a better way.

Euphoria is a very powerful, simple, easy to learn, FREE (unless you want bells and whistles) language

that has a lot of what Mike is looking for. Maybe the graphics are not as strong as he might like, but the ease of programming, the power, the ability to communicate with ports, and a pretty hefty user forum that usually has the answers should be useful. Euphoria is for DOS, any flavor of Windows, Linux, FreeBSD, and even has been ported to some embedded platforms. (www.rapid-euphoria.com/)

There might be some people playing with BASIC Stamps who use the language.

It's worth having Mike check it out.

Jon
Via Internet

Compilers Compiled

On Page 6 of the March 2005 issue of *Nuts & Volts*, Brian Schmaltz pointed out the omission of Liberty Basic in a previous issue (February 2005). For an even more extensive coverage of the Basic language go to <http://basic.mindteq.com/> where you will find the description of 63 Basic compilers and, if available, links to the respective download sites.

Duco W. Weytze
Via Internet

Published Monthly By
T & L Publications, Inc.
430 Princeland Ct., Corona, CA 92879-1300
(951) 371-8497
FAX **(951) 371-3052**
www.nutsvolts.com
Subscription Order ONLY Line
1-800-783-4624

FOUNDER/ASSOCIATE PUBLISHER
Jack Lemieux

PUBLISHER
Larry Lemieux
publisher@nutsvolts.com

**ASSOCIATE PUBLISHER/
VP OF SALES/MARKETING**
Robin Lemieux
robin@nutsvolts.com

EDITOR
Ryan Lee Price
ryan@nutsvolts.com

CONTRIBUTING EDITORS

Gerard Fonte	TJ Byers
Ed Driscoll	Jon Williams
Jeff Eckert	James Antonakos
Paul Verhage	Aaron Dahlen
Robert Diaz	Brian Mork
David Ward	John Iovine
Juan Morales	

CIRCULATION DIRECTOR
Mary Descaro
subscribe@nutsvolts.com

SHOW COORDINATOR
Audrey Lemieux

WEB CONTENT/NV STORE
Michael Kaudze
michael@nutsvolts.com

COVER ART
Michele Durant

PRODUCTION/GRAPHICS
Shannon Lemieux

STAFF
Dawn Saladino
Corrie Panzer
Kristan Rutz

Copyright 2005 by **T & L Publications, Inc.**
All Rights Reserved

All advertising is subject to publisher's approval. We are not responsible for mistakes, misprints, or typographical errors. *Nuts & Volts Magazine* assumes no responsibility for the availability or condition of advertised items or for the honesty of the advertiser. The publisher makes no claims for the legality of any item advertised in *Nuts & Volts*. This is the sole responsibility of the advertiser. Advertisers and their agencies agree to indemnify and protect the publisher from any and all claims, action, or expense arising from advertising placed in *Nuts & Volts*. Please send all subscription orders, correspondence, UPS, overnight mail, and artwork to: 430 Princeland Court, Corona, CA 92879.



RESOURCES UN-LTD.

SURVEILLANCE OPTICS ELECTRONICS
ORDERS. 800.810.4070
Tech 603.668.2499
fax 603.644.7825
WWW.RESULTD4U.COM

HEAVY DUTY, HIGH TORQUE, METAL CONSTRUCTION.

These are brand new, very rugged, right angle drive, gearmotors originally intended for an automotive application. They are very substantial, weighing over 2 pounds each! They offer a 0.9" diameter x 0.3"H, 9 tooth steel gear drive, located centered between three 0.28" diameter cast aluminum "spider" mounting points. Each offset 120° and on a diameter of 2.5". Overall size: 37"W x 7.25"L x 2"H including the gear with std. automotive style 2 pin connector. Motor will operate with good torque with as little as 3VDC. Hand twisting torque at 12VDC. Current is 850mA no load, with an RPM of 70/minute. Reversible.
WINMTR248.....\$20ea. 4 for \$69

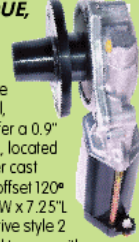

PHOTOMULTIPLIER TUBE, HAMMAMATSU TYPE R1512-04, IT'S BIG!

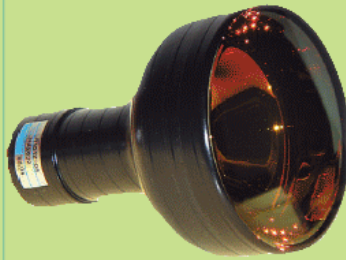

Spectral Resp. nm	300-600
Socket	E678-14
Dynode Structure	VB
No. of Stages	10
Luminous sensitivity typical	95 uA/lm
Blue Sensitivity (CS5-58)	11 Typ.
Q.E.at Peat Typical	27%
Anode to Cathode Voltage	1500v
Gain Typ.	1.1x10 ⁸
Luminous Typ.	100 A/lm
Dark Current Typical	20nA
Dark Current Maximum	100nA
New in manufacturers box. Ltd. Qty.	

PMT-R1512.....\$79ea.

WARNING LIGHT.
 New, boxed, 12VDC powered lamp with motorized rotating mirror. Red and blue dome & spare lamp supplied. Not Waterproof. Light your robot, get some attention.
ROTOLIGHT.....\$12ea.



BOSCH, DRILL MOTOR and GEAR DRIVE ASSEMBLY with CUSTOM SURFACE MOUNTING BRACKET!

These beauties have all the torque you could want....

Brand new in mfgs boxes, These assemblies normally provide the rotary motion for a quality Bosch 12V drill/driver. The assembly consists of a 17000RPM drive motor and a 14:1 planetary gear head with variable clutch. The motor operates from 3 to 12VDC. Measured data in table.

V (in)	I (inl)	Mtr RPM	Out RPM
3	3.5A	3400	242
6	5.0A	8000	571
9	5.7A	12500	893
12	6.0A	17200	1228

A unique, custom, glass filled plastic cradle mount is included for easy surface mounting. Overall size is 7.4"L x 2.4" diam. (3.3"W in the cradle) Threaded output shaft is 0.048" diam. Fifteen torque setting plus locked. We have a limited supply of these fantastic robotic drive motors. Order now, avoid disappointment. Mtr # 2606200917, Drive # 2607022890

DRILL DRIVE.....\$39set, Motor & Cradle 2 sets for \$69



SONY EX-VIEW CCD for the best "ASTRONOMICAL" PERFORMANCE available in an affordable camera!

With 600 Lines Resolution. NEW! 0.00005 Lux,

The most sensitive, uncooled, 1/2" CCD camera available.

Black and white, state of the Art Video, Our GMV-EX-6K, Takes the Prize. For covert, military & scientific applications, this is it. Unbelievable 0.00005Lux @ f0.8 performance is enhanced through low speed electronic shuttering, digital frame

integration and advanced DSP. Auto sensitivity mode starts as it becomes dark. 24 hour surveillance is possible with the optional f1.2 auto iris lens shown below. Seven Gain/Shutter modes are user selectable. Normal, X4, X8, X16, X24, X32, X64 X128. Frame rates of 60, 15, 8, 4, 3, 2, 1 and 0.5 per second. Auto/off BLC, S/N > 52dB, Mirror on/off, Gain on/off, auto electronic shutter 1/60 to 1/120,000 sec., Alum. housing, dual 1/4x20 mtg. Specs: 1/2" CCD, 768H x 494V, with 380K pixels, 12VDC

±1V@200mA, S-VIDEO on 4pin DIN connector. Std. video out on BNC. Size: 51mm x 51mm x 15mm long. Regulated power supply incl. All functions externally controlled. C-mount lens not included. We have the best price available for the 12VIE-EX CAMERA. VERY LIMITED QUANTITY AVAILABLE. DON'T BE FOOLED BY 1/3", NON - EXVIEW, LOOK ALIKES!
GMV-EX6K...\$449 Super, 6mm, f1.2 Manual Iris Lens...\$69

TWO LITTLE GEMS, MINI and MICRO, REVERSIBLE, HIGH TORQUE, DC GEARMOTORS. End effector or beam robot.

These precision motors were removed from new optical assemblies. They were intended to provide focus and aperture control for a large zoom lens.

The mini model (shown left) is from SAYAMA, # 43060300, size is 0.78"Diam. X 2.5"L with a 1.6"W mounting flange. Shaft is 0.155" Diam. The micro model (shown right) is from NAMIKI, PN ID, size is 0.47" Diam X 1.875"L with a 0.078"D shaft. A nice torque limiting drive gear is attached to each motor. (Can be easily removed) Motor specs are shown in tables below.

SAYAMA MINI.....\$15ea. SPECIAL.....3 for...\$49
NAMIKI MICRO.....\$20ea. SPECIAL.....2 for...\$35

V (in)	I (inl)	Out RPM
3	32mA	6
5	34mA	11
7	34mA	16
9	35mA	24
12	35mA	33

GEAR RATIOS
MINI 300:1
MICRO 150:1

V (in)	I (inl)	Out RPM
3	4.0mA	22
5	4.4mA	36
7	5.0mA	60
9	5.3mA	78
12	6.0mA	104

DON'T REINVENT THE WHEEL, IT'S BEEN DONE.... NEW, BALL BEARING MODEL is JUST WHAT YOU NEED!

Nice, 6" OD X 1"W, SKYWAY wheel. No mar gray, solid rubber tire on a glass filled, six spoke plastic rim. Metal, ball bearing hub with 0.31" ID shaft through hole. Ltd. qty. **SKYWHEEL...\$12/PAIR**



DC MOTOR drives FLEXIBLE SHAFT with LEAD SCREW and "NUT"

New, 18" L flex shaft enclosed in a 3/8"D protective sheath. One end "Plugs" into the motors right angle drive which outputs the flex rotation by turning of a 1/2" diam. x 7"L, 10 TPI lead screw upon which rides a 1" x T 2"L "nut /carriage" with two 1/4 x 20 threaded holes spaced 1" apart on the long axis. Flex shafts have a 0.14" x 0.14" square drive end. You receive one motor/shaft set. They were originally designed to move power seats. Heavy duty.

FLEX-DRIVE KIT.....\$24 2 for \$40

V (in)	I (inl)	Out RPM
3	1.1A	133
6	1.4A	295
9	1.6A	468
12	1.8A	642

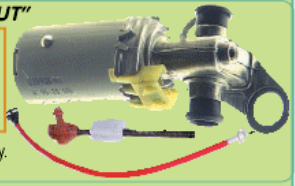

WE WANT TO BUY ESOTERIC AND UNUSUAL MATERIAL

LASER SCANNER, GSI LUMONICS, M SERIES, CLOSED LOOP, MOVING MAGNET MOTOR with capacitive position sensor. Speed & Accuracy!

Brand new, GSI Model: 3008522 mirror scanner. M-series optical scanners are the first in GSI product to use moving magnet technology. This robust design combines the sub-millisecond speed with the micro-radian accuracy second generation capacitive position detector. Excellent drift, noise, linearity and dynamic performance optimized to position mirrors between 9 and 20mm clear aperture. M2 scanners deliver the performance needed in most of today's beam and image steering applications.

Parameter	M2	Units
Max Scan Angle	±30°	degrees,optical
Non-linearity (max)	0.1	% over ±20° optical
Offset Drift (max)	30/10	μ radians/°C
Gain Drift (max)	100/20	ppm/°C
Operating Temperature	0-50	°C
Optimal mirror size	9-20	mm, clear aperture
Bandwidth (typ)	>2000	Hz
Small Step Response (typ)	<400	μs
Full Step Response (typ)	<2	ms

GSI SCANNER.....\$149ea. LIMITED QUANTITY

POWERFUL, "KID'S CAR" DRIVE MOTOR. MASSIVE GEAR REDUCTION for BIG TORQUE.

New, right angle drive system intended for use in a child's motorized vehicle. A powerful 12VDC motor drives the attached gearbox to provide final drive through a 1.75" diam. splined drive shaft. The 2.7" included, terminates notches for 0.43"Diam the hub.

V (in)	I (inl)	RPM	Amps
3	900mA	26	Loaded
6	1.0A	57	5A
9	1.1A	89	
12	1.2A	117	

CAR DRIVE FP...\$20ea. 2 for \$35

BOSCH, REVERSIBLE, HIGH TORQUE, DC GEARMOTOR, With 2.4" LONG STEEL SHAFT.

These are brand new, very rugged, right angle drive, gear motors originally intended for an automotive application. They are very substantial, weighing over 2 pounds each! They offer a 0.44" diam. x 2.4"L steel drive shaft located centered between three 0.45" diameter cast aluminum "spider" threaded mounting points. Each offset 120° and on a diameter of 2.75". Overall size: 5"H x 7.5"L x 2.7"W Motor will operate with wrist twisting torque. As little as 3VDC lights it up, nominal is 12VDC. Draws about 4.5 A under load. All metal construction. Also it is of course, reversible.

V (in)	I (inl)	RPM
3	2.7A	16
6	3.1A	39
9	3.3A	63
12	3.5A	88

RA DRIVE with SHAFT.....\$24ea. SPECIAL.....2 for \$39

REVERSIBLE, HIGH TORQUE, AC GEARMOTOR, ORIENTAL MOTOR, MODEL 2RK6GN/2GN15KA

A super nice, matched, 1450 RPM, 1/125HP motor & 15:1 gearbox provide 100rpm at the 0.3" diam. x 1.1" out-put shaft. Shaft rotation is the same as the motor shaft. Instantly reversible capacitor start motor. (Cap. supplied) operates from 115VAC @ 0.19A. Torque is 4.4lb in. Regular \$135 each. Limited quantity. Overall size is: 2.4" X 2.4" x 4.25" Long. Weight 1.5lbs.

OM-2GN15K.....\$20 or 3 for \$49

LIKE THIS STUFF? SEE MORE ON-LINE at OUR WEB STORE. 2005 our 14th Year!

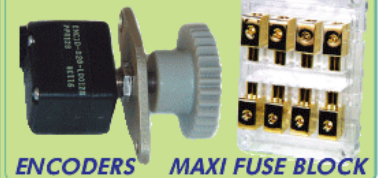

ENCODERS MAXI FUSE BLOCK

The Latest in Networking and Wireless Technologies

Open Communication

The Magic of Antennas

If you really want to know what makes any wireless application work, it is the antenna. Most people working with wireless — radio to those of you who prefer that term — tend to take antennas for granted. It is just something you have to add on to a wireless application at the last minute. Well, boy, do I have news for you. Without a good antenna, radio just doesn't work too well. In this age of store/online-bought shortwave receivers, scanners, and amateur radio transceivers, your main job in getting your money's worth out of these high-ticket purchases is to invest a little bit more and put up a really good antenna. In this column, I want to summarize some of the most common types and make you aware of what an antenna really is and how it works.

Transducer to the Ether

In every wireless application, there is a transmitter and a receiver. They communicate via free space or what is often called the ether. At the transmitter, a radio signal is developed and then amplified to a specific power level. Then it is connected

to an antenna. The antenna is the physical "thing" that converts the voltage from the transmitter into a radio signal. The radio signal is launched from the antenna toward the receiver.

A radio signal is the combination of a magnetic field and an electric field. Recall that a magnetic field is generated any time a current flows in a conductor. It is that invisible force field that can attract metal objects and cause compass needles to move. An electric field is another type of invisible force field that appears between conductors across which a voltage is applied. You have experienced an electric field if you have ever built up a charge by shuffling your feet across a carpet then touching something metal ... zaaapp. A charged capacitor encloses an electric field between its plates.

Anyway, a radio wave is just a combination of the electric and magnetic fields at a right angle to one another. We call this an electromagnetic wave. This is what the antenna produces. It translates the voltage of the signal to be transmitted into these fields. The pair of fields are launched into space by the antenna, at which time they propagate at the

speed of light through space (300,000,000 meters per second or about 186,000 miles per second). The two fields hang together and in effect, support and regenerate one another along the way.

This strange relationship was proved mathematically by physicist James Clerk

Maxwell in the late 19th century. Therefore, we call these Maxwell's equations and they are at the heart of all wireless systems. The radio wave then passes by the receiving antenna and induces a voltage into it that contains all of the originally transmitted signal. The receiver then amplifies this voltage and recovers the information.

So, in summary, an antenna is a transducer for converting a voltage into a radio wave and then converting the radio wave back into the voltage. Any antenna will work just as well at sending as it does at receiving, and you will hear this referred to as antenna reciprocity. Also, let's get this straight right now: If you do not have an antenna, you won't have any wireless communications. Even a bad antenna is better than none at all.

Those who really appreciate what antennas do are those people who had to fool around with TV antennas back before cable (BC). No antenna, no TV. If you were lucky enough to be near a TV station, you could use the epitome of all antennas — rabbit ears. Don't you remember how you had to rotate them, adjust their length, and even attach aluminum foil to them to get a good picture? It was even more of a big deal if you had to have an outside antenna. You had to adjust the direction of the antenna to get the best reception. You discovered the basic rule of antennas used for high frequencies: the taller, the better.

If you are a ham, I won't belabor the point. You know darn well that most of your experimentation as a ham has probably been with antennas. You have to have one even if your equipment is totally store-bought or

Figure 1. A dipole is a pair of conductors that, together, are a half-wavelength long at the operating frequency.

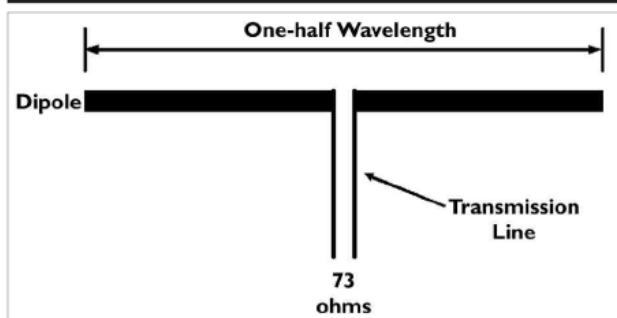

home brew. It is a never-ending battle.

For you shortwave listeners, antennas are also critical. Although you can often get by with short inside antennas if you have a good receiver for just listening. If you have ever tried an outside antenna, you know that the longer and higher it is, the better the reception. If you are into scanners, you know that an outside antenna up high is the ticket to maximum coverage.

Today, most of the antennas we encounter are built-in. We have car antennas, cell phone antennas, and those in family radios and CBs. If you use any wireless networking products – like Wi-Fi in a laptop – the antennas are built in, but are just as important. And just try to get a good satellite TV signal without a dish antenna pointed in the right direction. Anyway – and pardon the pun – you get the picture. That seemingly worthless collection of wires, conductors, and copper patterns are the key to good communications.

Antenna Basics 101

Most antennas are some variation of the basic antenna that we call a dipole. A dipole is a pair of conductors that, together, are a half-wavelength long at the operating frequency (see Figure 1). A wavelength is the distance between adjacent peaks or troughs of the radio wave fields. This distance is dependent upon the frequency of the signal. You can calculate wavelength represented by the lowercase Greek lambda – λ – with this formula:

$$\lambda = 300,000,000/f$$

The 300,000,000 is the speed of light in meters and f is the operating frequency in Hz. Since our antennas are mostly used at the higher frequencies, we can use the formula:

$$\lambda = 300/f_{\text{MHz}}$$

The wavelength is in meters. For example, a 150 MHz signal's wavelength is:

$$\lambda = 300/150 = 2 \text{ meters}$$

You can also calculate wavelength in feet using the formula:

$$\lambda = 984/f_{\text{MHz}}$$

The dipole has a length of one-half wavelength, or $\lambda/2$. This length for wire antennas is computed with the formula:

$$\lambda/2 = 492/f_{\text{MHz}}$$

However, if the antenna is wire or some other thin conductor, this has to be modified to:

$$\lambda/2 = 468/f_{\text{MHz}}$$

Let's say you want an antenna to receive the WWV time signal at 10 MHz. A dipole for that frequency will be:

WIRELESS MADE SIMPLE™

BRING YOUR WIRELESS PRODUCT QUICKLY AND LEGALLY TO MARKET

RF MODULES

Add **INSTANT** wireless analog / digital capability to your product.

Low-Cost TX & RX Modules

Multi-Channel Modules

Transceiver Modules

OEM PRODUCTS

FCC PRECERTIFIED & ready to customize for your application.

Handheld TX's

Keyfob TX's

Function Modules

ANTENNAS

From ceramic chips to gain yagis, keyless entry to WIFI.

Specialty

GPS

Embedded Chips

Low-Cost Permanent

Whips

Magnetic Base

Gain Antennas

www.linxtechnologies.com

www.digkey.com
1-800-DIGI-KEY

Proudly Distributed by:

www.rfdigital.com
1-818-541-7622

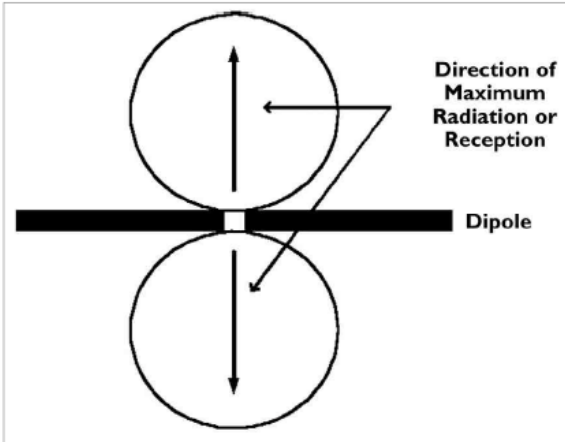

Figure 2. The radiation pattern is actually a figure-eight pattern.

$$\lambda/2 = 468/f_{\text{MHz}} = 468/10 = 46.8 \text{ feet}$$

Each section of the dipole then is one-half that length or $46.8/2 = 23.4$ feet or about 23 feet and five inches.

This antenna will be resonant to 10 MHz. It acts just like a resonant inductance-capacitance-resistance (LCR) circuit. At the operating frequency, it appears to be a resistance of about 73 ohms. It does have a certain amount of bandwidth, but — if you stray too far from the resonant point — the antenna begins to look like complex impedance that is a combination of resistance and reactance, capacitive at lower frequencies and inductive at the higher frequencies.

You also need some way to connect the antenna to the receiver or transmitter. This is done with a transmission line. The most widely used type of transmission line is coax cable.

Figure 3. Another common antenna type is the quarter-wave ($\lambda/4$) ground plane.

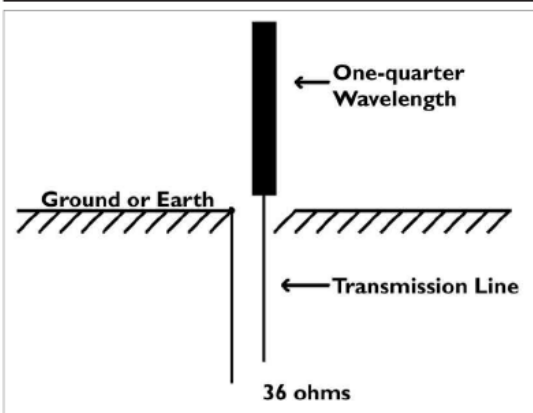

You can get a coax cable with a 75-ohm characteristic impedance that is a very close match to the antenna's impedance. RG-59/U is one example, as is RG-6/U, which is commonly used in cable TV systems.

As it turns out, most people use a 50-ohm coax with a dipole because it is the most common impedance used for inputs and outputs on receivers and transmitters. There are lots of different types of 50-ohm cable, like RG-58/U, RG-8/U, and RG-213/U. There are many others. Even with the difference between 50 and 75 ohms, this mismatch doesn't matter that much. As it turns out, the impedance of the dipole at resonance varies considerably with the height above the ground. The 73-ohm value doesn't really become the actual impedance until the antenna is over one wavelength above the ground. This is pretty high at the lower frequencies and is rarely attained. That is why the antenna is such a good match to the common and cheap 50-ohm cable.

The dipole is actually a directive antenna. That is, it does not radiate the electromagnetic waves equally in all directions. The radiation pattern is actually a figure-eight pattern, as shown in Figure 2. Looking down on the antenna from above, the maximum horizontal radiation pattern is at a right angle to the line of the antenna wire. If you can think in 3-D for a minute, visualize that figure eight as a doughnut-shaped pattern. Looking at the pattern, there is actually very little radiation from the ends of the antenna. Now you can see why it is important to orient the antenna for the desired direction of transmitting or receiving.

Incidentally, if you mount the antenna vertically, its antenna pattern is a circle. We call this omnidirectional. It radiates

or receives equally well in all directions. This is a pretty tricky thing to do physically with long wire antennas, so this technique only works for short antennas used at high frequencies.

That brings up one more key antenna fundamental: polarization. Polarization is defined as the direction of the electric field with respect to the Earth. If the dipole is mounted horizontally, the polarization will be horizontal. Mounting the antenna vertically produces vertical polarization. Ideally, you want both the transmitting and receiving antennas to use the same polarization for maximum signal strength, but, as it turns out, as the wave travels over long distances it is rotated a bit, so you can still get reception of a vertically polarized signal on a horizontal antenna and vice versa.

Another common antenna type is the quarter-wave ($\lambda/4$) ground plane (see Figure 3). What it amounts to is half of a dipole, mounted vertically. The center conductor of the coax attaches to this vertical conductor while the shield of the coax connects to ground. The ground (or Earth) acts like the other half of the dipole. The nice thing about a ground plane is that the length of the antenna is half that of the dipole. This is a big deal at the lower frequencies.

For example, the length of a dipole for an AM radio transmitter at 650 kHz (0.65 MHz) will be:

$$\lambda/2 = 468/f_{\text{MHz}} = 468/0.65 = 720 \text{ feet}$$

The actual formula for a quarter wave ground plane is:

$$\lambda/4 = 234/f_{\text{MHz}} = 234/0.65 = 360 \text{ feet}$$

Note, if we use a quarter-wave ground plane, the length is only 360 feet. Think of the cost difference between a 720-foot tower and a 360-foot tower — big difference.

In most applications, the Earth is not used as the other side of the dipole. Instead, at the higher frequencies, we often use a large metal area — larger than one-quarter wave-

Open Communication

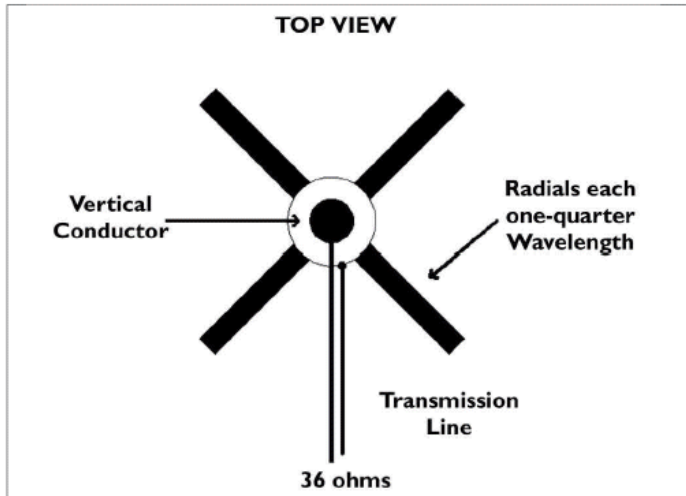

Figure 4. In some antennas, an array of radials is used.

length. For example, on car antennas, the ground plane is the metal surface of the car surrounding the antenna. In some antennas, an array of radials is used (see Figure 4). Note that there are four or more conductors of $\lambda/4$ mounted at the base of the vertical segment of the antenna. These may be wires on lower frequency antennas or short horizontal conductors in higher frequency antennas.

In any case, the ground plane antenna is also resonant at its frequency of operation. The resistive value of its feed point is about 36 ohms. Normally, we use a 50-ohm coax cable to feed the ground plane, as it is a close match and works well. The radiation pattern for the ground plane is a circle, meaning that it is omnidirectional and transmits and receives equally well in all directions.

Common Antenna Types

Most radio applications use a dipole or a ground plane, but there are many other special types of antennas. Almost all of them are some variation of either the dipole or the ground plane. A good example is the widely used Yagi. Take a look at Figure 5. This antenna uses a dipole as the antenna, but parasitic elements are added to shape the radiation pattern.

The longer element next to the dipole — or driven element — is called the reflector. It actually does reflect (at least redirect) some of the energy from the dipole in the forward direction. The shorter element is called a director. It further helps focus the radio wave in the forward direction. The end result is that the dipole energy is concentrated and directed in one direction, making the antenna directive. The radiation pattern looks something like what you see in Figure 6.

The Yagi antenna has what we call gain. It actually boosts the signal level because the electromagnetic energy is focused in one direction. For example, if your transmitter puts out one watt of power and you connect it to a Yagi, the actual effective radiated power (ERP) may be five times that — five watts. The receiver doesn't know the difference between a plain old five-watt transmitter on a sim-

PIC Programming Made Easy! Proton+ PICBASIC Development Suite

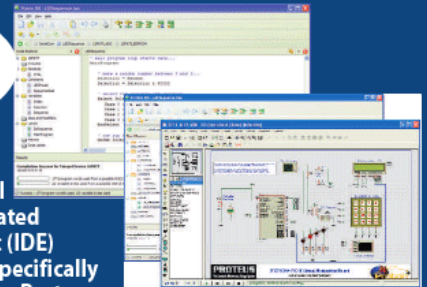

Next Generation IDE

Proton IDE is a professional and powerful visual Integrated Development Environment (IDE) which has been designed specifically for the Proton Plus compiler. Proton IDE accelerates product development in a comfortable user environment without compromising performance, flexibility or control.

- Integrated Bootloader
- Serial Communicator
- Code Explorer
- Compiler Results
- Online Updating
- Plugin Architecture
- Programmer Integration
- Real Time Simulation Support

INTRODUCTORY OFFER!
Save \$10
LIMITED TIME

Visit www.r4systems.com to see our latest **Proton+** projects

SAVE TIME WITH END TO END INTEGRATIONS

NEW IDE - New IDE makes development using Proton+ even faster and more intuitive!
COMPILER - The popular Proton+ compiler has enhanced support for I²C, SPI, Dallas 1-wire bus, RS232, X10, Compact Flash Memory Cards and USB.
VIRTUAL SIMULATION - Simulate your project in RealTime using the integrate Proteus Virtual PIC Boards.

PROTEUS

The Complete
Electronics
Design System



EASY TO USE
CAD TOOLS AT
FANTASTIC PRICES!

Schematic and PCB Layout

- Powerful and flexible schematic capture.
- Auto-component placement.
- Polygonal gridless ground planes.
- Library of over 8000 schematic and 1000 PCB foot prints.
- Bill of materials, DRC reports and more.

Mixed Mode SPICE Circuit Simulation

- Berkeley SPICE3F5 simulator with custom extensions for true mixed mode and interactive simulation.
- Six virtual instruments and 14 graph based analysis types.
- 6,000 models including TTL, CMOS and PLD digital parts.
- Fully compatible with manufacturers' SPICE models.

Proteus VSM - Co-simulation & debugging for popular Micro-Controllers

- Supports PIC16 & PIC12, AVR, 8051, HC11 and ARM micro-controllers.
- Latest version includes 40 new PIC18's.
- Co-simulate target firmware with your hardware design.
- Includes interactive peripheral models for LED and LCD displays, switches, keypads, virtual terminal and much, much more.
- Provides source level debugging for popular compilers and assemblers from HiTech PICC, Crownhill, IAR, Keil and others.

PCB AutoRouting

- Proteus PCB design includes an interface to the Electra Gridless autorouter.

FREE DOWNLOADABLE DEMO! Save Time. Save Money.
Proteus Starter Kit - \$199 • Complete Systems from \$499
"This is clearly superior in every respect."

R4 SYSTEMS INC. www.r4systems.com info@r4systems.com
Tel: 905-898-0665

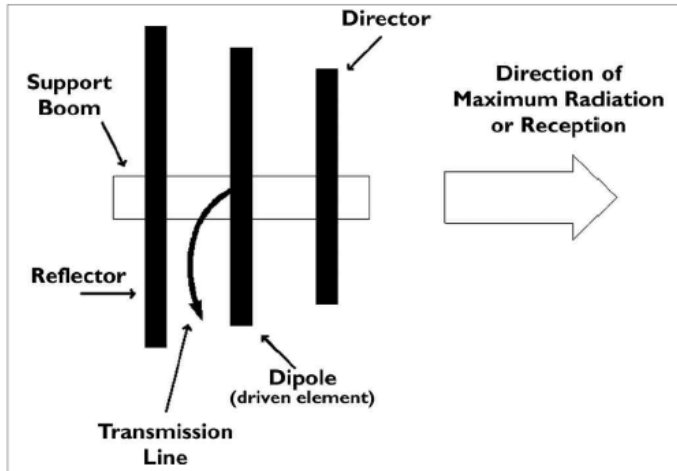

Figure 5. The Yagi antenna uses a dipole as the antenna, but parasitic elements are added to shape the radiation pattern.

ple dipole or a one-watt signal from a Yagi. You can actually get much higher gains by adding more directors. Yagis with up to 20 directors are available to give super high gains. The downside is that the antenna is highly directive so you have to point it correctly to get the signal.

Another common type of antenna is the parabolic dish (see Figure 7). It is used mainly at microwave frequencies above 1GHz. The dish, as it is called, has a parabolic shape that takes the energy from an antenna like a dipole and concentrates all its radiation into a highly focused radio beam. The antenna signal reflects off of the dish and, because of its unique geometric shape, all of the waves are concentrated into a very narrow beam. This makes the dish very highly directive, but the upside is the super high gain. You can see why a

extremely small when it gets to Earth. The dish has a very high gain, so it, in effect, boosts the signal level before it gets to the receiver.

Another type of antenna you don't see much of, but that is widely used, is the patch antenna. It, too, is used mainly at microwave frequencies. A very common application is with wireless local area networks (WLANs) that connect PCs and laptops. Popular access points, called hot spots, allow laptops to connect to the Internet at many public places, like airports, hotels, and coffee shops. The antenna used in many of these 2.4-GHz radios is a patch. It is essentially just an area of copper on a printed circuit board (PCB) about one-half wavelength in size that may be square or circular (see Figure 8). A copper ground plane on the other side of the PCB acts like a reflector to

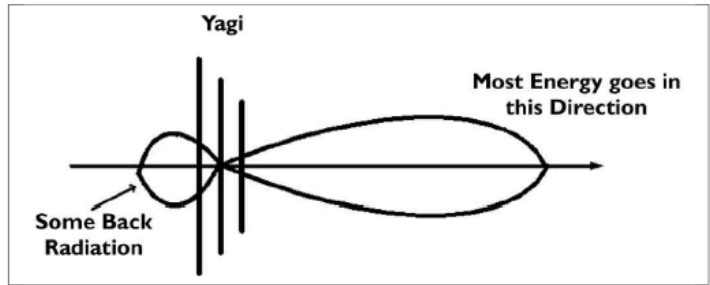

Figure 6. The dipole energy of the Yagi is concentrated and directed in one direction, making the antenna directive.

focus the energy forward.

You can actually put multiple patch antennas on a large PCB and drive all of them simultaneously. This gives lots of gain and directivity. You can even control the phase of the signals to or from the antenna, making it possible to shape the radiation pattern or the gain on the fly. These are called phased arrays and they are widely used in military radar, but they are becoming more popular in cell phone systems and WLANs.

Anyway, I am out of space for this issue. I will follow up in a later column with more antenna types. For now, pay attention to your antenna. It will make your seemingly failed wireless project a true success. **NV**

For Your Info ...

The February Open Communications column covered the Ramsey QRP transmitter kits. In lieu of the schematic diagrams, the photos were accidentally printed instead. Ramsey has made the schematics available for those of you who need access that information. Visit <http://ramseykits.com/qrp>

Figure 7. Another type of antenna is the parabolic dish similar to any satellite dish system.

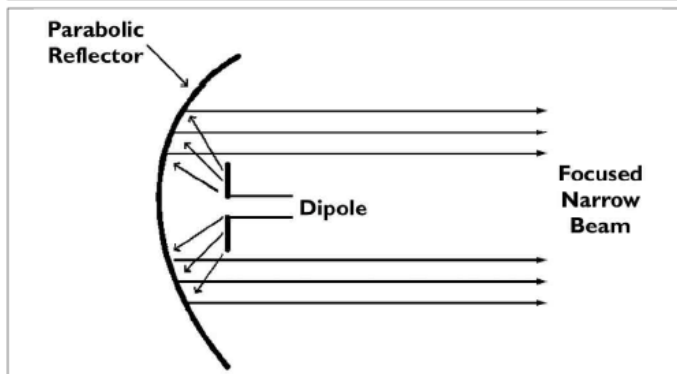
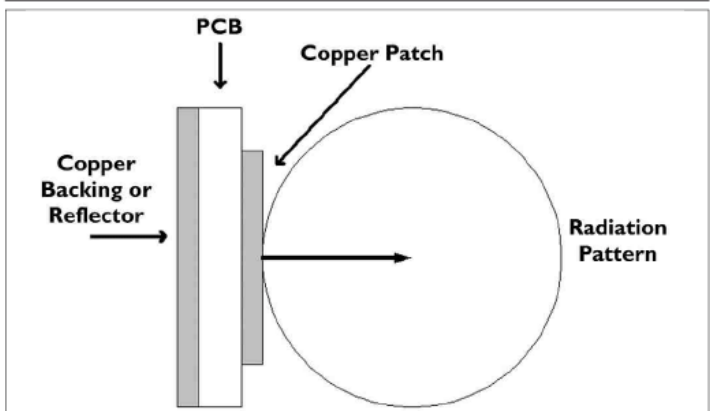

Figure 8. The antenna used in many 2.4-GHz radios is just an area of copper on a PCB about one-half wavelength in size.



PolarisUSA Video, Inc.

22 Years of Service! 1983 - 2005

POLARISUSA.COM

YOUR ONE STOP SUPPLY FOR ALL YOUR VIDEO SECURITY NEEDS



E-400-DVR

\$539.95

4-Channel DVR with Audio.
TCP/IP Monitoring
Embedded Hard Drive
- Not Included
Motion Detection
M-JPEG Compression

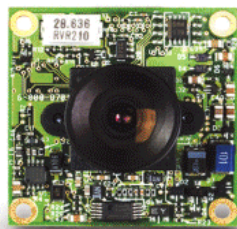

Side View

MB-1250U

\$89.95

1/3" CCD Color
Microboard Camera

380-470 TVL
0.5 LUX / 2X ZOOM



ILC-300

\$189.95

1/4" Color Infrared
Lipstick Camera

470 TVL / 4.3mm



DX-8263SL

\$249.95

1/3" High Resolution
Color Star Light Camera

470 TVL / 0.003 LUX

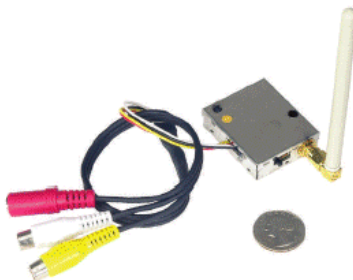

MPX-2400

\$89.95

2.4 GHz Video Transmitter
Module

4 Channel Video, Mono
Audio



IRCAM-CL

\$219.95

1/4" Color Infrared CCD Camera

420 TVL and 6mm Lens
Weather-Resistant



(Back View)



XDC-220IR

\$799.95

1/4" CCD Color IR Camera
220X Zoom Day/Night

Autofocus / 470 TVL / Infrared

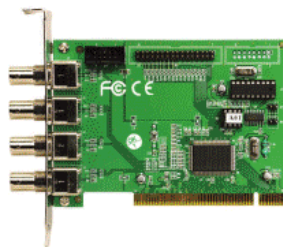

DVC-140PRO

\$99.95

4 Camera PCI Card

View Up to 16 Cameras
Using Your PC!
(With All 4 Cards Installed)



HVS-D2

\$59.95

1/3" CCD Color
Dome Camera

380 TVL / 3.6mm

Toll Free
800-308-6456

Circle #32 on the Reader Service Card.

PolarisUSA Video

Local
678-405-0089

Video Security From The Professionals at Polaris

PolarisUSA Video, Inc. • 3158 Process Drive • Norcross, GA • 30071

Audio/RF Signal Generator

- ✓ DDS and SMT technology!
- ✓ 0 Hz to 5 MHz at 0.1Hz resolution!
- ✓ 0 to 10V peak to peak output level
- ✓ Sine, Square, or Triangle waveform

Following our world famous SG550, we are proud to introduce the SG560, the next generation signal generator!

To begin with we increased the frequency range all the way up to 5MHz and all the way down to 0Hz (yes, we mean zero...or DC!) continuously in 0.1Hz steps across the entire range! Then we gave it a variable output level all the way up to 10V peak to peak in either Sine, Square, or Triangle waveforms! You can also provide a DC offset to the output to recreate TTL, 4000 series logic levels, low voltage logic levels, AC waveforms with a DC component, or just plain AC signals!

SMT and DDS technology is used throughout the SG560 for ultimate performance and reliability. If you're looking for a lab quality sig gen at a super hobbyist price, the brand new SG560 fits the bill...and a whole lot more!

SG560WT Audio/RF Signal Generator, Factory Assembled

\$329.95



Hand Held Digital Scope With DVM Readout

- ✓ Digital waveform and measurement display!
- ✓ 10MHz and 40MHz sample rates!
- ✓ Backlit LCD display
- ✓ RS232 output (40MHz model only)
- ✓ Charger, case, probes included

We've seen a lot of portable scopes and scope/meters, and we've also seen the price tags! They have always been way out of the reach and budget of the hobbyist. No more! Now for close to the price of a good DMM you can have a personal scope that also has DVM readout for dBm, dBV, DC, and True RMS! Frequency readout is also displayed on the screen through markers, plus the scopes have two memories for digital storage.

The 40MHz model also includes an RS232 output and serial interface to capture the screen display on your scope to your PC at the mere push of a button! These scopes run on 5 standard AA Alkaline batteries (not included) which provide up to 20 hours of use. You can also use rechargeable AA NiMH batteries instead and they'll be charged with the included power supply! Both units come with a custom foam lined high impact carrying case, set of high quality scope probes, AC power adapter and a comprehensive user's manual. If you're working with electronic circuits, automotive applications, audio and stereo applications or other applications, the personal scope is for you...at a price that can't be beat!

HPS105E Personal Handheld 10MHz Digital Scope
HPS40 Personal Handheld 40MHz Digital Scope w/RS232
PS28 9VDC Power Supply/Charger

\$229.95
\$299.95
\$9.95



Dual Display DMM With RS232 Output

- ✓ RS232 output to your PC!
- ✓ Digital and analog bargraph display
- ✓ Backlit LCD display with data hold
- ✓ Manual and auto ranging
- ✓ Includes probes, RS232 cable, & software

We gave you an inexpensive pocket DMM for under 20 bucks. Then we gave you a super multi-purpose professional multimeter that measured virtually everything for 40 bucks. What's next, you ask? You won't believe it! Everything PLUS RS232 serial data output for connection to your PC! That's right, now you can measure, control, and store your DMM and its readings on a graphical display on your PC!

Features both auto and manual ranging with a large 3 3/4 digit display with a 38 segment analog bargraph. Selectable backlight and data display hold features are also included. Plug in the provided DB9 serial cable to your PC, load the included software, and you're off and running with a remote control digital multimeter from your PC! Includes standard test probes, temperature test probes, professional rubber holster, RS232 cable, installed 9V battery, Windows software CD, all in a neat travel case.

DVM345DI Dual Display DMM With RS232 Output

\$84.95



Sniff-It RF Detector Probe

- ✓ Use with any DMM or VOM to measure RF!
- ✓ Low cost RF measurement!
- ✓ Can also be used as a field strength meter
- ✓ 100kHz to 1000MHz!

The RF1 is a very sensitive RF detector probe that connects to any digital multimeter and provides a DC voltage output from weak RF signals. This allows very easy tracing of low level RF signals that a counter can not pick up. Wide frequency coverage of 100 KHz to over 1000 MHz lets you track down most any problem in transmitter chains, receiver stages, or even complex PLLs.

Uses exotic, low barrier microwave detector diodes to give exceptional sensitivity which can see signals down to microwatt levels! A great low cost way of checking for RF. Fully assembled and tested, and includes standard banana plugs for use with any standard VOM, DMM or voltmeter. If you need to measure RF and don't want to spend big bucks, here you go!

RF1 RF Sniff-It Probe

\$329.95



**Mini-Kits...
The Building Blocks!**

Tickle-Stick

The kit has a pulsing 80 volt tickle output and a mischievous blinking LED. And who can resist a blinking light! Great fun for your desk, "Hey, I told you not to touch!" Runs on 3-6 VDC

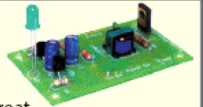

TS4 Tickle Stick Kit

\$12.95

Super Snoop Amplifier

Super sensitive amplifier that will pick up a pin drop at 15 feet! Full 2 watts output. Makes a great "big ear" microphone. Runs on 6-15 VDC



BN9 Super Snoop Amp Kit

\$9.95

Dripping Faucet

Produces a very pleasant, but obnoxious, repetitive "plink, plink" sound! Learn how a simple transistor oscillator and a 555 timer can make such a sound! Runs on 4-9 VDC.



EDF1 Dripping Faucet Kit

\$9.95

LED Blinky

Our #1 Mini-Kit for 31 years! Alternately flashes two jumbo red LED's. Great for signs, name badges, model railroading, and more. Runs on 3-15 VDC.



BL1 LED Blinky Kit

\$7.95

Touch Tone Decoder

Strappable to detect any single DTMF digit. Provides a closure to ground up to 20mA. Connect to any speaker, detector or even a phone line. Runs on 5 VDC.



TT7 DTMF Decoder Kit

\$24.95

Electronic Siren

Produces the upward and downward wail of a police siren. Produces 5W output, and will drive any speaker! Runs on 6-12 VDC.

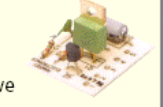

SM3 Electronic Siren Kit

\$7.95

Universal Timer

Build anything from a time delay to an audio oscillator using the versatile 555 timer chip! Comes with lots of application ideas. Runs on 5-15 VDC.



UT5 Universal Timer Kit

\$9.95

Voice Switch

Voice activated (VOX) provides a switched output when it hears a sound. Great for a hands free PTT switch, or to turn on a recorder or light! Runs on 6-12 VDC and drives a 100 mA load.



VS1 Voice Switch Kit

\$9.95

Tone Encoder/Decoder

Encodes OR decodes any tone 40 Hz to 5KHz! Add a small cap and it will go as low as 10 Hz! Tunable with a precision 20 turn pot. Runs on 5-12 VDC and will drive any load up to 100 mA.



TD1 Encoder/Decoder Kit

\$9.95

RF Preamp

Super broadband preamp from 100 KHz to 1000 MHz! Gain is greater than 20dB while noise is less than 4dB! 50-75 ohm input. Runs on 12-15 VDC.



SA7 RF Preamp Kit

\$19.95

Touch Switch

Touch on, touch off, or momentary touch hold, your choice! Uses CMOS technology. Runs on 6-12 VDC and drives any load up to 100 mA.



TS1 Touch Switch Kit

\$9.95

Where The Fun Begins!

The Newest Neatest Stuff!

Ion Generator

- ✓ Generates negative ions!
- ✓ Blast of fresh air, no noise!
- ✓ Generates DC, not pulsed!
- ✓ 7.5kV DC negative, 400uA!

This nifty kit includes a pre-made high voltage ion generator potted for your protection, and probably the best one available for the price. It also includes a neat experiment called an "ion wind generator". This generator works great for pollution removal in small areas (Imagine after Grandpa gets done in the bathroom!), and moves the air through the filter simply by the force of ion repulsion! No fan blades, no noise, just swiftly moving, charged air.

Learn how modern spacecraft use ions to accelerate through space. Generate negative ions for health and healing! Includes ion power supply, 7 ion wind tubes, and mounting hardware for the ion wind generator.

IG7 Ion Generator Kit \$64.95
AC125 110VAC Power Supply \$9.95

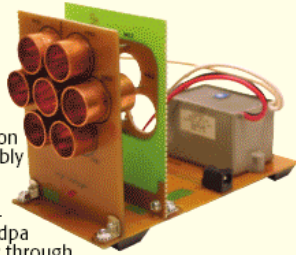

Electrocardiogram Heart Monitor

- ✓ Visible & audible display of your heart rhythm
- ✓ Re-usable sensors included!
- ✓ Monitor output for your scope
- ✓ Simple & safe 9V battery operation

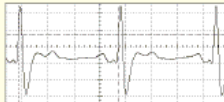

Enjoy learning about the inner workings of the heart while at the same time covering the stage-by-stage electronic circuit theory used in the kit to monitor it.

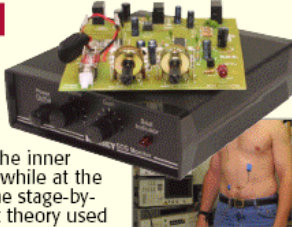

The three probe wire pick-ups allow for easy application and experimentation without the cumbersome harness normally associated with ECG monitors. The fully adjustable gain control on the front panel allows the user to custom tune the differential signal picked up by the probes giving you a perfect reading every time! Multiple "beat" indicators include a bright front panel LED that flashes with each heart beat, an adjustable audio output to hear the beat, and of course, the monitor output to view on a scope, just like in the ER! Operates on a standard (and safe) 9VDC battery. Includes matching case for a great finished look. The ECG1 has become one of our most popular kits with hundreds and hundreds of customers wanting to get "Heart Smart"!

ECG1C Electrocardiogram Heart Monitor Kit With Case \$44.95
ECG1WT Factory Assembled & Tested ECG1 \$89.95
ECGP10 Replacement Reusable Probe Patches, 10 Pack \$7.95

Plasma Generator

- ✓ Generates 2" sparks to a handheld screwdriver!
- ✓ Light fluorescent tubes without wires!
- ✓ Build your own plasma balls!
- ✓ Generate up to 25kV @ 20KHz from a solid state circuit!

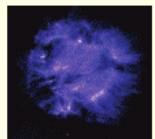

This new kit was conceived by one of our engineers who likes to play with things that can generate large, loud sparks, and other frightening devices. The result... the PG13 Plasma Generator designed to provide a startling display of high voltage!

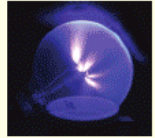

It produces stunning lighting displays, drawing big sparks, to perform lots of high voltage experiments. In the picture, we took a regular clear "Decora" style light bulb and connected it to the PG13 - WOW! A storm of sparks, light tracers and plasma filled the bulb. Holding your hand on the bulb doesn't hurt a bit and you can control the discharge! It can also be used for powering other experiments; let your imagination be your

guide! Can also be run from 5-24VDC so the output voltage can be directly adjusted.

PG13 Plasma Generator Kit \$64.95
PS21 110VAC input, 16VAC output power supply \$19.95

Robot Car

- ✓ Senses sound and turns!

This little car may not look like a robot, but it sure acts like one! Designed to look like a futuristic vehicle, the on-board "power train" drives it in a straight path. But a highly sensitive microphone on the board detects sounds, and changes the direction of the car! You can whistle to it, yell at it, and it will change directions! When it runs into a wall or obstacle, it moves away from it! Runs on 2 standard AA batteries (not included).

KSRI Robot Car Kit \$19.95



IR Illuminator

- ✓ See in the dark!

Allow your CCD camera to see in the dark with our IR1 Infrared Illuminator! A huge array of 24 high intensity infrared LEDs illuminate a good size area so the camera "thinks" it's daylight! The illumination provided is about the same as you would expect from a very bright wide beam flashlight. The illuminator runs on 12-15VDC and is built on a convenient PCB ready to install wherever you need it.

IR1 IR Illuminator Kit \$29.95



Electronic Watch Dog

- ✓ Sound activated barking dog on a PC board!

It's nice to have a barking dog to react to someone at our door. But not all of us can have a dog! No problem there, build your own! Two distinct barking sounds are sound activated with a built-in microphone that has adjustable sensitivity. I wish my dog had adjustable sensitivity! This dog eats 9-12VDC. Easy kit assembly.

K2655 Watch Dog Kit \$32.95



Stereo Super Ear

- ✓ Amplifies sound 50 times!

The "Super Ear" is an ultra high gain amplifier that includes two super sensitive mics at a 45 degree angle to give you a true stereo output. Includes on/off switch and volume control. Standard audio jack is provided for audio output. Runs on 3 standard AAA batteries (not included). Easy to assemble and fun to use!

MK136 Super Ear Kit \$9.95



Electronic Learning Labs



- ✓ Learn and build!
- ✓ 130, 300, & 500 In One!
- ✓ Super comprehensive training manuals!

Whether you want to learn the basics of electricity, the theory of electronics, or advanced digital technology, our lab kits are for you! Starting with our PL130, we give you 130 different electronic projects, together with a comprehensive 162 page learning manual. A great start for the kids...young and old!

Step up to our PL300, which gives you 300 separate electronic projects along with 165 page learning and theory manual. The PL300 walks you through the learning phase of digital electronics.

If you're looking for the ultimate lab kit, check out our PL500. Includes a whopping 500 separate projects, a 152 page starter course manual, a 78 page advanced course manual, and a 140 page programming course manual! The PL500 covers everything from the basics to digital programming! Learn about electronics and digital technology the fun way and build some neat projects!

PL130 130 In One Learning Lab Kit \$42.95
PL300 300 In One Advanced Learning Lab Kit \$69.95
PL500 500 In One Super Learning Lab Kit \$169.95

MORE than just friendly on-line ordering!

Clearance Specials, Ramsey Museum, User Forums, Dealer Information, FAQ's, FCC Info, Kit Building Guides, Downloads, Live Weather, Live Webcams, and much more!

www.ramseykits.com

800-446-2295



590 Fishers Station Drive
Victor, NY 14564
(800) 446-2295
(585) 924-4560

Where
Electronics
Is Always
FUN!

- ◆ Build It!
- ◆ Learn It!
- ◆ Achieve It!
- ◆ Enjoy It!

Circle #39 on the Reader Service Card.

Prices, availability, and specifications are subject to change. Visit www.ramseykits.com for the latest pricing, specials, terms and conditions. Copyright 2005 Ramsey Electronics, Inc...so there!



Get The Catalog!

Get the brand new 2005 Ramsey Hobby Catalog! 64 value packed pages of the neatest goodies around! Order your copy on-line or give us a call!

TechKnowledgey 2005

Events, Advances, and News From the Electronics World

If you see anything revolutionary and interesting — or just plain cool — while surfing newsgroups, filtering press releases, or simply doing your job, drop me a line about it. Have questions or comments about what you read here in “Techknowledgey 2005?” Send those my way, too. You can reach me at www.jkeckert.com

— Jeff Eckert

Advanced Technologies Computing Breakthrough Could Antiquate Transistors

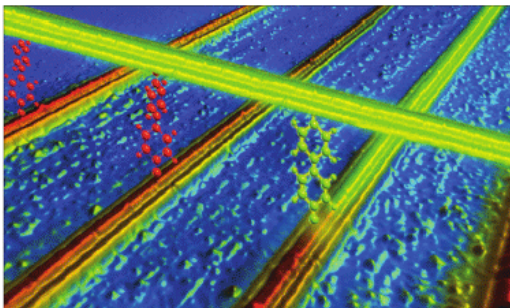

This is an artist's conception of a molecular electronic circuit. Molecular switches connect nanometer-scale wires into different planes to form a crossbar array. Graphic courtesy of Madworks Concept Images.

Hewlett-Packard (www.hp.com) recently announced that a technology invented by its researchers in 2003 has been proven to be a new way to construct computers as well as a viable replacement for the transistor. In a paper published in the *Journal of Applied Physics*, three members of HP Labs' Quantum Science Research (QSR) group described how a “crossbar latch” can provide the signal restoration and inversion required for general computing with no need for tran-

sistors. The technology could result in computers that are thousands of times more powerful than contemporary machines.

The latch, demonstrated experimentally, consists of a single wire acting as a signal line, crossed by two control lines with an electrically switchable molecular-scale junction where they intersect. By applying a sequence of voltage impulses to the control lines and using switches oriented in opposite polarities, the latch can perform the NOT operation, which — along with AND and OR — is one of three basic operations that make up the primary logic of a circuit and are essential for general computing.

In addition, it can restore a logic level in a circuit to its ideal voltage value, which allows a designer to chain many simple gates together to perform computations.

Standard semiconductor circuits require three-terminal transistors to perform the NOT operation and restore signals. However, it is generally believed that transistors will not be able to shrink down to the size of a few nanometers and remain operable.

QSR works on nanoscale electronic devices that will first supplement and, someday perhaps, replace silicon technology that is expected to reach its physical limits in about a decade.

In addition to exploring the fundamental scientific principles of computing at the molecular level, QSR is also looking at architectural issues to determine how such tiny devices — thousands of which could

fit across the diameter of a human hair — could be fabricated economically and in mass quantities.

Magnetic Particles Help Detect Alzheimer's

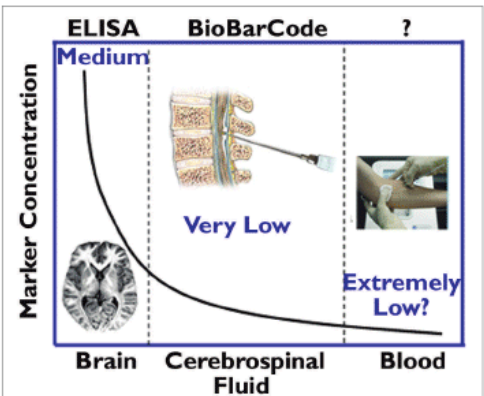

Detection of Alzheimer's Disease

The bio-barcode amplification technology can detect ADDLs in cerebrospinal fluid, where the biomarker is present in very low concentrations. Photo courtesy of Northwestern University.

Using a novel bio-barcode amplification (BCA) technology, researchers from the National Science Foundation (NSF, www.nsf.gov) and Northwestern University (www.northwestern.edu) have detected a protein linked to Alzheimer's disease in fluid from around the brain and spinal cord. If proven successful in further clinical studies, the procedure could become the first tool for early diagnosis of Alzheimer's and the first test to conclusively identify the disease in living patients. Because of the extreme sensitivity of the BCA process, the researchers were able to detect within each fluid sample a minuscule amount of proteins called amyloid β -derived diffusible ligands (ADDLs). The goal is

to detect and validate infinitesimal amounts of the biomarkers in the blood.

In the first steps of the BCA process, special magnetic microparticles latch onto the biomarker targets (in this study, the ADDLs). Researchers then add a second ingredient that consists of a gold nanoparticle core surrounded by hundreds of identical DNA strands, which serve as hundreds of bio-barcodes that are detected at the end of the test.

Ultimately, the gold DNA particles and magnetic particles sandwich the biomarker targets. A magnet separates the sandwiched complexes from the rest of the sample. After which, the complexes are heated to release the DNA bar codes, which are measured by an extremely sensitive detector.

Each DNA piece greatly increases the sensitivity of the test and its potential to tell doctors that a patient carries the ADDLs. Apparently, BCA is about one million times more sensitive than the next best thing — standard enzyme-linked immunoassays (ELISAs). BCA could eventually be configured to detect hundreds of diseases simultaneously, including AIDS and prostate cancer.

Computers and Networking Tiny Flash Memory

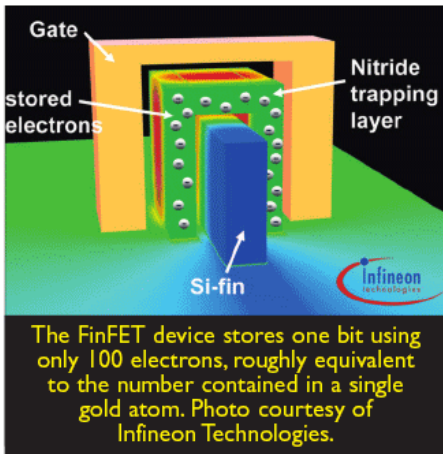

Scientists at Infineon Technologies AG have announced construction of the world's smallest nonvolatile Flash memory cell, measuring a mere 20 nm. Assuming that all manufacturing-related challenges (including that of the lithography) can be

resolved, the development would make nonvolatile memory chips with a capacity of 32 GB possible within a few years.

Nonvolatile Flash memories are commonly used as mass storage media for devices such as digital cameras, camcorders, and USB sticks. The most advanced nonvolatile Flash memory devices available today can permanently store one or two bits of information per memory cell without a supply voltage. Such memories have a feature size of around 90 nm, and significantly shrinking this feature size has posed many problems because of nanoscale physical effects.

In particular, fabricating 20-nm, Flash memory cells has been considered nearly impossible because these

physical effects would make the memory cells extremely unreliable.

Infineon researchers overcame this challenge by creating a three-dimensional structure with a fin for the transistor that acts as the heart of the memory cell. The special geometry minimizes unwanted effects and significantly improves electrostatic control compared to today's flat transistors. Called a FinFET (fin field effect transistor), the Infineon device stores the electrons that carry the information in a nitride layer that lies electrically isolated between the silicon fin and the gate electrode. Just eight nm thin, the fin is controlled by the 20-nm-wide gate electrode. The devices won't be commercially available for a few years, but you can check on their progress at www.infineon.com

Mac Mini

Back in days of yore (January 24, 1984, to be specific), Apple (www.apple.com) introduced the original Macintosh with a price of just under \$2,500.00. Based on the Consumer Price Index, this equals \$4,555.00 in 2005 currency. For that, you got an 8-MHz processor, 128K of RAM, no hard drive, and a built-in nine-inch monitor. Storage was provided by a single 3.5-inch 400K

DATA ACQUISITION INVENTORY CONTROL

GOING WIRELESS IS EASY!

BLUETOOTH MODULES - RS-232
Low Cost
Easy To Use

Long Range
Class I & II

900 MHz WIRELESS RF MODULES
Transmitters, Receivers, Transceivers,
High Speed, Long Range, UHF Modems

Call Toll Free 866-345-3667

LE MOS

INTERNATIONAL
Electronic Manufacturers Representatives
RF & Microwave Specialists

www.lemosint.com



The Mac Mini is the smallest and cheapest Macintosh ever. Photo courtesy of Apple Computer, Inc.



Laptop bags define "where fashion meets function." Photo courtesy of Circuit City.

newer car keys and wireless payment tags may not keep thieves at bay.

Using a relatively inexpensive electronic device, criminals could wirelessly probe a car key tag or payment tag in close proximity and then use the information obtained from the probe to crack the secret cryptographic key on the tag. By obtaining

floppy drive.

As of early this year, you could buy a Mac Mini, the latest desktop model, for \$499.00 (or \$274.00 in 1984 dollars), making it the cheapest Mac ever offered. At just two-inches tall and a weight of less than three pounds, it's also the smallest. On the downside, it is powered by a G4 processor rather than its G5 big brother and the price doesn't include a monitor, keyboard, or mouse.

Still, you get a 1.25 GHz clock rate, 256 MB of RAM, ATI Radeon 9200 graphics, a drive that plays DVD movies and burns CDs, and a 40 GB hard drive. For an extra hundred bucks, you can boost that to 1.42 GHz and an 80 GB drive.

The Mini also includes a 56k modem, 10/100 base-T Ethernet, and a built-in speaker and head-phone jack. Furthermore, it comes with OS X and the latest version of iLife®, which includes iPhoto®, iMovie®, iDVD®, GarageBand®, and iTunes® digital music software. So, if you have been wanting a Mac, but balked at the typical \$1,800.00 starting price, this could be the one you've been waiting for.

Laptop Bags for Women

If you have been losing sleep because your laptop ensemble isn't chic enough, the Anika line of bags and accessories sold by Circuit City (www.circuitcity.com) will come to your fashion rescue. No longer will friends and associates

sneer at your boring, black baggage. According to a company spokesman, "The women of Circuit City are a driving force behind the Anika line. These associates saw a need for fun, colorful laptop bags and decided to take the idea from the drawing board to the sales floor." The company apparently has noticed that 37 percent of all laptops are purchased by women.

The Anika collection is available in six designs and features custom yarn-dyed, rubber-backed fabrics, splash-proof zippers, and quilted linings to protect computers, accessories, and files. The line includes carry-all bags, laptop bags, camera bags, camcorder bags, CD wallets, and a wheeled overnight case.

Circuits and Devices RFID Vulnerability Discovered

If you begin experiencing inexplicably high gasoline expenses or are having your car stolen every week or so, the problem may be with the radio frequency identification (RFID) system used in your car key or oil company payment tag. Some computer scientists at Johns Hopkins University (www.jhu.edu) and RSA Laboratories (www.rsasecurity.com/rsalabs) recently revealed that the encryption in RFID microchips in some

this key, lawbreakers could more easily circumvent the auto theft prevention system in that person's car or potentially charge their own gasoline purchases to the tag owner's account.

Security verification is based on a challenge/response protocol between the key or tag and the reader, and the researchers were able to unravel the mathematical process used in this verification. They then purchased a commercial microchip costing less than \$200.00 and programmed it to find the secret key for a gasoline purchase tag. By linking 16 such chips together, the group cracked the secret key in about 15 minutes.

More than 150 million of these transponders are embedded in keys for newer vehicles built by at least three leading manufacturers. The transponders are also inside more than six million key chain tags used for wireless gasoline purchases.



Security issues are discovered with car keys and gas pump passes. Photo by Will Kirk.

Guitars and Whiskey



Peavey's new line of guitars and amps sports a Jack Daniel's theme. Photo courtesy of Peavey Electronics.

For the guitarist who enjoys Jack Daniel's (Has any guitarist ever not enjoyed Jack Daniel's?), Peavey has introduced a new line of instruments and amplifiers. In the photo is a single cutaway Peavey Jack Daniel's USA electric guitar, constructed using mahogany for the body and neck and a solid, five-amp, quilt-maple archtop. Peavey's patented dual-compression bridge system creates a metal-to-metal connection designed to provide singing sustain and stronger string presence.

The guitars also feature ebony fretboards, two dual-wound, hum-canceling pick-ups, chrome Schaller tuners, and special wooden control and selector switch covers cut from actual used Jack Daniel's whiskey barrels. For information on this and other products in the family, visit www.peavey.com

Incidentally, we were unable to verify rumors that Peavey has also been working on an Acapulco Gold product line for decades, but the designers just haven't made much progress.

Industry and the Profession

2004 PC Shipments Up

According to Gartner, Inc. (www.gartner.com), worldwide PC shipments increased in 2004 by 11.8 percent over 2003, primarily because of strong mobile PC sales. The top-five vendors were Dell (31 million units), Hewlett-Packard (27.5 million), IBM (10.4 million),

APRIL 2005

Fujitsu/Fujitsu Siemens (7.1 million), and Acer (6.3 million). The "others" category totaled 106 million units sold. Data include desktop PCs, mobile PCs, and X86-32 servers.

Free Online Books

Members of the IEEE Computer Society now have unlimited

online access to a rotating collection of 300 unabridged technology books. Subjects include enterprise computing, graphics and multimedia, hardware, networks, security, software engineering, and more.

Larger collections are also available for a fee. For more information, visit www.computer.org/bookshelf **NV**

\$51 For 3 PCBs

FREE Layout Software!

FREE Schematic Software!

- 01 DOWNLOAD our free CAD software
- 02 DESIGN your two or four layer PC board
- 03 SEND us your design with just a click
- 04 RECEIVE top quality boards in just days

expresspcb.com

Understanding, Designing, and Constructing Robots and Robotic Systems

Personal Robotics

LEGO My ...

LEGO® has become something of a household word. If you grew up in the 50s or later, you probably owned a set or hoped to, in any case. It is not only a part of our culture, but also has international appeal. LEGO started out making small wooden toys in the 1930s. They slowly grew, adding plastics to their repertoire of materials.

After a fire burned their facilities to the ground in 1942, they dropped their wooden line of toys completely, focusing on plastics only. Several times in their history, they have made leaps and bounds in the level of technical detail of their toys, electrifying them and adding lights, culminating with their Mindstorms™ line.

Adding hundreds of different technical parts, including switches, pneumatics, light sensors, and motors, LEGO is really a great way to get into robotics and design with-

out having to cut or drill materials. There are thousands of websites out there featuring everything from plotters to photographic instruments, all built with LEGO. With so many different projects available, focusing on one is nearly impossible.

Of the nearly 200 LEGO Mindstorms titles listed on amazon.com, one caught my interest. *Competitive Mindstorms*, by David J. Perdue (ISBN 1-59059-375-8), is not only interesting and well-written, but it turns out that the author was only 16 when he penned this masterful tome on LEGO Mindstorms sumo combat. Given the amount of passion behind the works of the young Mr. Perdue, I decided to look into the Mindstorms thing myself.

I managed to haggle with a fellow employee, trading an old motorboat engine for a slightly used Mindstorms kit. My older Robotics

Invention kit came to me in pristine condition with all the bags intact. I certainly got the better end of the deal on that one.

Following the text was easy and construction is well laid out. David has a good programming style and his code is well commented. I, too, agree with his choice of using “Not Quite C” as the native language of programming the bricks is annoying at best, and I had to deal with upgrades and such to use my older set with my current OS.

Personally, I found the selection of sensors extremely limiting. As far as the microcontroller is concerned, I felt like my hands were tied in tight little knots. In all fairness, when I first started out (about 2,500 years ago, it seems), this would have been a blessing to have; it is just that I long since grew past this level of sensing and control. I played a bit with the examples, but my imagination was hindered by the hardware.

In all fairness, I have to mention that there are a lot of aftermarket capabilities out there for sensing. On one website alone, I found infrared rangers and rotation sensors, as well as books on the subject of hacking the system to add more sensing functionality.

The mechanics themselves are excellent and the selection of parts is awesome. For a beginner, this book and a Mindstorms kit will take you very, very far. For the seasoned professional, perhaps you will find the limitations to be a challenge or you might choose to

Chameleobot the quadruped.

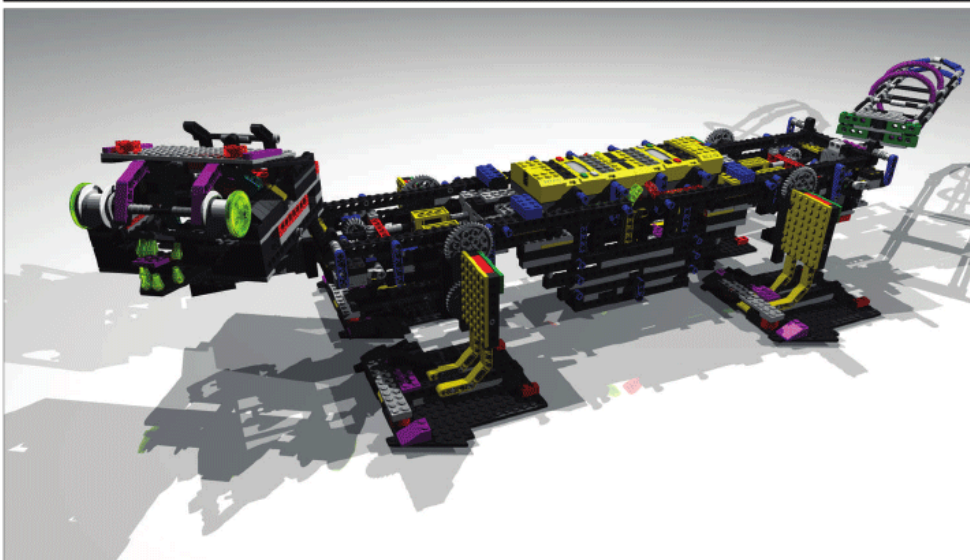

adapt different microcontrollers to the system.

Along these lines, I would like to show off my newest conquest from Charmed Labs (www.charmedlabs.com), the Xport 2.0. The Xport2.0 is really a neat device. It takes the power of a Gameboy Advance, running an ARM processor, and adds — of all things — a Xylinx field programmable gate array (FPGA).

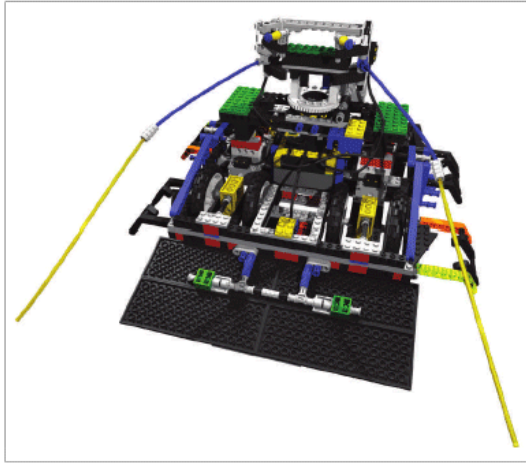

Gargantuan-bot Version BL58.



Zip-Bam-Bot Version XK2.

Imagine:

- 32-bit ARM processor running at 16 MHz
- 256-plus-K RAM (several areas of RAM for different purposes)
- 240 x 160-pixel display, 65,000 colors
- Five graphics modes
- 128 sprites

And if that weren't enough, add the Xport's capabilities:

- 150,000 logic gates
- 64 I/O lines
- 4 Mb of Flash
- 16 Mb of SDRAM
- Real-time operating system (RTOS)
- A/D converter wired to do back-EMF integration for position control

For those of you wondering what to do with an FPGA, it really comes down to what *not* to do with an FPGA. What not to do is process an analog signal, unless you digitize it first. Other than that, the world is your digital oyster. Take any digital module from just about any microcontroller and, basically, there is something that can be done: hardware serial ports, PWM modules, quadrature encoder readers (or generators), high-speed buffered serial ports. With 64 I/O lines, I can run more servos than I can afford and still have I/O lines available to build a serial port. Add to that a seductive LCD display, good sound quality on the Gameboy Advance (Gameboy Advance SP is backlit!),

and you have a really innovative product.

Unfortunately, every silver cloud has a dark lining. The learning curve on this is going to be steep. I am not a "software guy" by trade, but the effort put in will be returned 10 times over, no doubt. If

you are willing to learn about the Gameboy architecture, the acclaimed GCC compiler, and maybe a little something about FPGA programming, then be prepared to impress yourself.

The Xport 2.0 in itself is mind-boggling as a software and firmware



Be an FCC LICENSED ELECTRONIC TECHNICIAN

GET YOUR FCC COMMERCIAL LICENSE!

No costly school. No commuting to class. The Original Home-Study course prepares you to be an "FCC Commercial Licensed Technician" at home in your spare time! You don't need a college degree to qualify, but you do need an FCC License. No need to quit your job or go to school. This proven course is easy, fast and low cost! No previous experience needed!

This valuable license is your "ticket" to thousands of exciting jobs in:

- Communications
- Radio-TV
- Broadcasting
- Avionics
- Radar
- Maritime
- and more...even start your own business!

GUARANTEED TO PASS
You get your FCC License or your money refunded.

Get your FREE facts now. Call Today!
800-932-4268 Ext. 102
 or go online at
www.LicenseTraining.com

COMMAND PRODUCTIONS • FCC License Training
 P.O. Box 3000 • Sausalito, CA 94966-3000



Earn up to
\$100 an Hour
 and More!

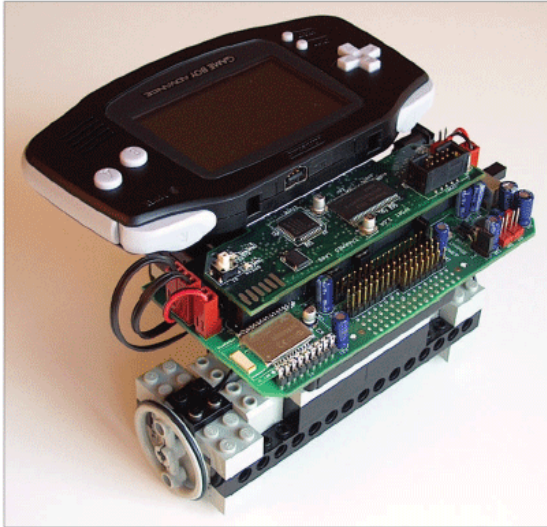

X-port in a differential drive configuration.

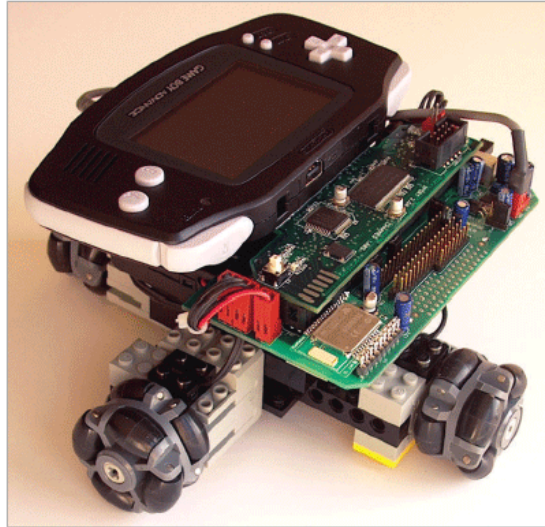

X-port in a holonomic drive configuration.

tool, but — when combined with LEGOs — it enables software-oriented people to build really cool hardware and lets hardware gurus make their creations animated to the *n*th degree. If you are a strict mechanical guy, this may not be a match for you, unless you are willing to stay within the scope of the demos supplied.

My personal Mindstorms battle plan is four pronged. I am looking at building my own sensor bricks. I am learning the Gameboy Advance

and re-learning C; eventually, I will tackle the FPGAs. To get me going, I am working with my Plugapod from NewMicros, Inc., building a small board with a couple of H-bridges on it, along with a carrier for the unit.

I am also re-evaluating my turtles and shrimps idea from a few columns ago. I have found a software genius named Scott Settembre who is helping me with the code. My original battle plan was to laser cut everything, but now I think I will

be using a Plugapod board I built with dual H-bridges and LEGO Mindstorms.

Just as a quick overview, the idea is to simulate an evolving program on a PC and then, every time a generation meets a certain level of ability, it is uploaded to a few dozen robots that act out the generated code. Rather than having a slick, 3-D rendered display, we will have an arena of little LEGO bots looking for food in

the form of colored disks, picking them up, reading the data on them, digesting, and finally excreting the disks upside down, revealing a different color pattern.

This will require attractive, robust mechanisms that are capable of a reasonable degree of mechanical complexity. Adding LEGO to the mix will produce an air of familiarity and, hopefully, an air of magic.

Another interesting aspect of LEGO is the CAD software that is available for it. LDraw, available from www.ldraw.org and combined with more advanced graphical user interface (GUI) “wrappers” that they link to off the site, provide you with a really nifty CAD setup.

Some of these “wrappers” will even export to POV Ray or other third-party renderers for some truly stunning graphics. There is an all-inclusive download that includes the most popular tools available at www.ldraw.org/modules.php?op=modload&name=News&file=article&sid=104

Overall, I have to say that my experience with the Mindstorms products has been pleasing, but I won't be shelving my laser cut parts just yet. I will be bonding my creations with some sort of glue and, as much as it breaks my heart, it is a necessary thing to keep them from falling apart. **NV**

Get the Laser Edge.

Our advanced technology delivers fast, accurate and affordable custom enclosures and front panels.

- ★ **Quick**
- ★ **Affordable**
- ★ **Precise**
- ★ **No Minimums**



Integrated Ideas & Technologies, Inc.
Precision Laser Cut Stencils

3896 N. Schreiber Way • Coeur d'Alene, ID 83815-8362 USA
Ph (208) 665-2166 • Fax (208) 665-5906 • www.integratedideas.com

Need Device Connectivity To The Pervasive Internet?*

Save Money, Save Time, Use The PowerCore

"Based on experience, I can tell you that Rabbit stuff works before you can get it all out of the box."

—Fred Eady, *Circuit Cellar*

The Core of your Embedded System

The PowerCore FLEX is a complete Rabbit microprocessor system with optional features such as a power supply, Ethernet, and a low-cost rugged A/D system. It plugs into a motherboard you design. You pay only for the options you need, and we quickly manufacture it. Development Kits include a powerful software development platform and extensive libraries.

Network and Internet Support

Your embedded device can network and serve web pages. Hardware and software supports Ethernet, Wi-Fi, and cellular telephone data networks. TCP/IP and most associated protocols are included in the Development Kit. SSL secure server software and other premium software modules are available at a nominal cost. With the implementation of optional software modules such as RabbitWeb, SSL, PPP, and AES, you can securely and conveniently communicate with your embedded device from anywhere in the world.



Development Kit Includes

- A loaded PowerCore FLEX with all options or non-Ethernet low-end version
- Prototyping board with development area.
- Documentation on CD.
- Dynamic C integrated development environment.
- Serial cable, power supply, and more.



Kits From \$129

Free Reference Book With Kit!

"Embedded Systems Design using the Rabbit 3000 Microprocessor" free with PowerCore kit purchase.

www.rabbitFLEX.com



\$49 Value

Free Book

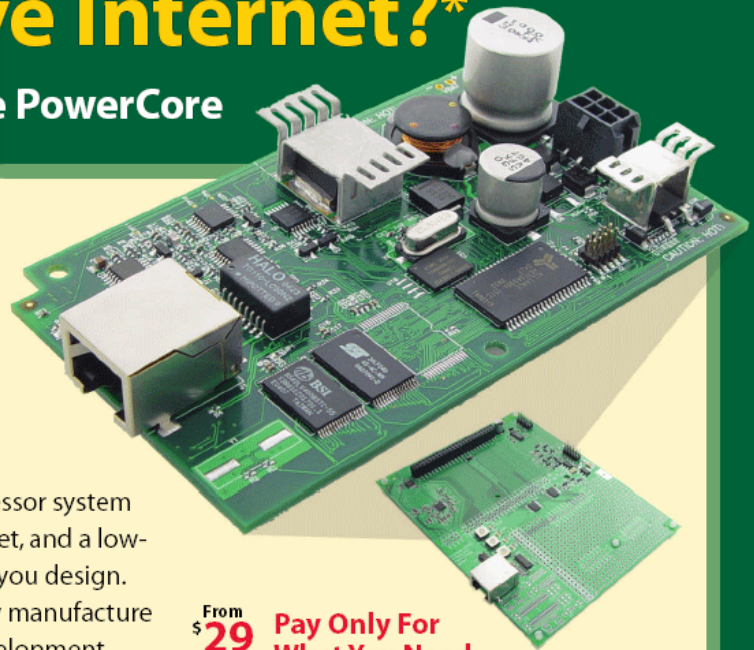

From \$29 Pay Only For What You Need
qty. 5000

Configurable Features

- Microprocessor Speed
- On-Board Power Supply
- SRAM / Flash
- Serial Data Flash
- Ethernet Option
- A/D Converter System
- Battery-Backed SRAM



Standard Features

- 39 General Purpose I/O
- 5 Serial Ports
- Real-Time Clock
- Watchdog / Supervisor

* *Pervasive Internet: Embedded devices providing internet connectivity for commercial and industrial applications. Learn more at www.rabbitflex.com*

RABBIT
Semiconductor



2932 Spafford Street, Davis, CA 95616
Tel 530.757.8400

Circle #37 on the Reader Service Card.

Electronics Q&A

In this column, I answer questions about all aspects of electronics, including computer hardware, software, circuits, electronic theory, troubleshooting, and anything else of interest to the hobbyist.

Feel free to participate with your questions, comments and suggestions.

You can reach me at:

TJBYERS@aol.com

What's Up:

Extending relay

contact life. A 20

watt stereo amp

using two chips.

Model RR goodies.

And a geography

brain teaser.

Relay Contact Life

Q I am using a DPDT relay to control a 90-volt DC motor that pulls 1.5 amps under full load. The relay contacts are rated for 10 amps at 240 VAC. The problem is that the contacts have welded shut. From ancient memories, I dredged up the idea that I'd seen a capacitor used across contacts to reduce the arcing. I've been through most of my old electrical engineering resources and found almost nothing relating to this idea.

To calculate what I needed, I dug out the formula that $I = C \, dv/dt$. Assuming the voltage change (dv) is 90 volts, the time (dt) is 1 mS, and the current is 1.5 amps, I come up with the equation that C (capacitance I need) = $0.001(1.5/90)$ or roughly $1.6 \, \mu\text{F}$ to adequately absorb the spark. I connected a $2.2\text{-}\mu\text{F}$, 250-volt cap across the points and it seems to be running smoothly. My question is, am I even close?

**Greg Smith
via Internet**

A You arrived at the right answer in a roundabout way — and by an error in your math. The answer to your equation is actually $16 \, \mu\text{F}$, not

$1.6 \, \mu\text{F}$, yet $1.6 \, \mu\text{F}$ is the correct value. The rule of thumb for this method is 0.5 to $1.0 \, \mu\text{F}$ per amp. In your case, 1.5 amps works out to be $1.5 \, \mu\text{F}$ — very close to your $1.6 \, \mu\text{F}$ “calculation.” You were correct, though, in selecting a 250-volt capacitor for the application. The thumb rule says 200 to 300 volts.

However, there is a caution when using this method. As the capacitance increases, so does the charge and amount of stored energy that's in the capacitor. This is energy and current that must be discharged through the contacts — at the rate of $I = C \, dv/dt$, when they close. (See where your formula comes into play?)

This current surge may be enough to weld the contacts and actually countermand your solution. The ideal way to suppress the arc without risking contact damage on subsequent closure is to add a resistor in series with the capacitor, as shown in Figure 1. The value of the resistor is typically 0.5 to 1.0 ohms per volt — about 50 ohms, in your case. So the no-math rule is $1 \, \mu\text{F}$ per amp and 0.5 ohms per volt.

To express it mathematically, we need nothing more than Ohm's Law and a capacitor charge formula. When the points separate (break), the current flow wants to keep flowing, and it will do so by striking an arc. The criteria for creating and sustaining an arc is complex, but suffice it to say that, once an arc is struck, the harder it is to extinguish because it creates its own self-sustaining environment — much like a forest fire creates its own winds to feed itself.

The conditions required to initiate an arc depend on the voltage across the opening contacts (gap) and the current at the time. Now, if we place a

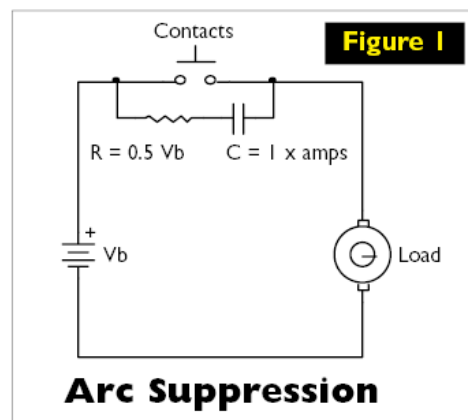

capacitor across the contacts, the cap acts like a short circuit when the contacts open. At this point, the cap begins to charge using the formula $t = RC$, where R can be calculated from $R = E/I$, E being the voltage across the points and I being the current flowing at the time of the break.

If we can balance the charging time of the capacitor with the time it takes for the contacts to open wide enough that the voltage can't jump the gap, the arc is suppressed. Typically, this is 0.1 mS for a frame relay of the type you describe. Plugging these values into our equations, we get $R = 90 \text{ volts}/1.5 \text{ amps} = 60 \text{ ohms}$. Calculating for capacitance, we get $C = t/R = 0.0001/60 = 1.67 \mu\text{F}$.

If you're trying to figure out the mathematics for an AC voltage suppressor, forget it. A sine wave is self-extinguishing because it crosses zero. That is, two times every cycle, the voltage across the contacts is zero as the voltage reverses itself from positive to negative. It's very hard to maintain an arc under these conditions — as many a welder will attest to.

EMF Suppression

Q How come you sometimes put a diode backward across the relay contacts and other times you don't? I have read that the diode is a must. What's the real story?

**Mike Edwards
Los Angeles, CA**

A I think you're talking about putting the diode across the relay coil, not the contacts, but they are both one and the same. When the current flow through an inductor — or coil — is interrupted, a high voltage in the reverse direction is generated by the collapsing magnetic field. This voltage can be as high as 10 times the Vcc source voltage.

If the coil is connected to a transistor or other semiconductor, the back EMF (as it's called) can be high enough to destroy the device. The

same happens across the relay contact when connected to an inductive — like a motor described in the question "Relay Contact Life" — where this creates contact arcing. This is energy that must be dissipated somehow.

A diode placed across the inductor (or contacts) will conduct when the magnetic field collapses and will effectively short circuit the voltage. The decision whether to use a diode or not depends on the voltages and currents involved. A coil with higher inductance, like a frame relay, will store more energy — both voltage and current — than will a small coil, like a reed relay. As a rule of thumb, a diode should always be included — but other factors have to be considered, not the least of which is space. If the relay is small, space is limited, and Vcc is low, I often omit the diode.

Also, placing a diode across the inductor causes current to flow longer and lengthens the hold-in time of the relay. This is unac-

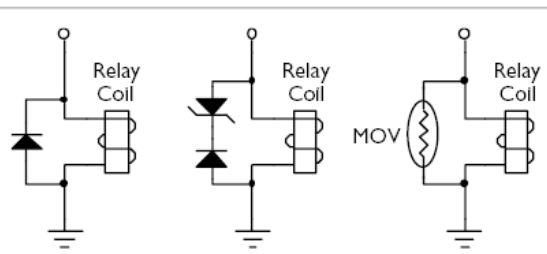

Figure 2 EMF Suppression

ceptable for some applications. By inserting a zener diode in series with the rectifier, hold-time is greatly reduced. This is because the diodes can't conduct until the reverse voltage exceeds the zener voltage, plus 0.7 volts.

In some circuits, the diode(s) can

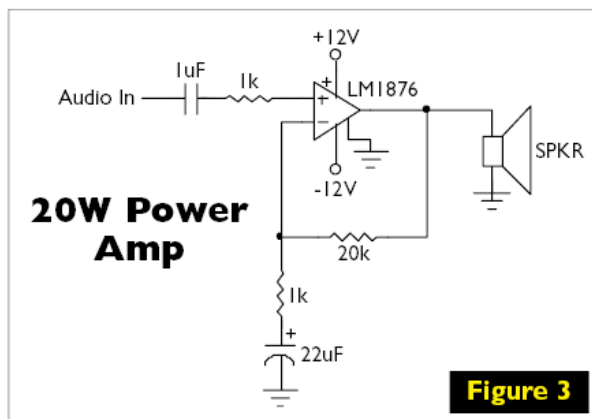

Figure 3

Front Panels?

Download the free Front Panel Designer to design your front panels in minutes

Order your front panels online and receive them just in time

www.frontpanelexpress.com

Unrivaled in price and quality for small orders

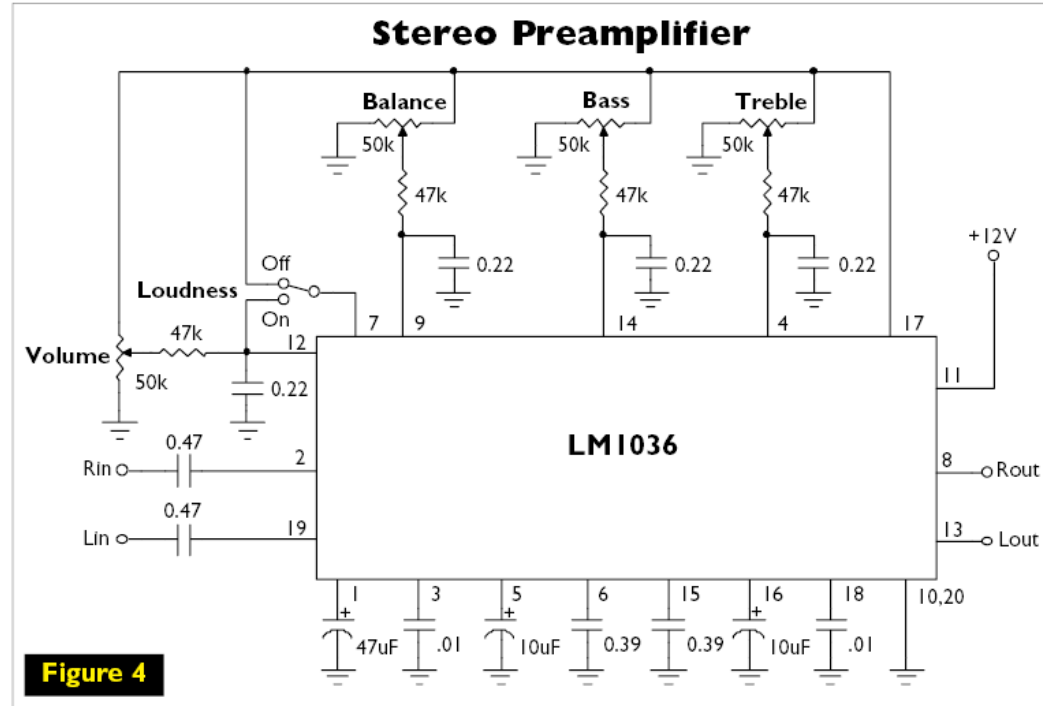

Figure 4

be replaced with a metal-oxide resistor (MOV). An MOV behaves like back-to-back zeners and can be used in both DC and AC circuits (see Figure 2). The choice usually boils down to available space and cost. An ideal suppression voltage is 10 volts; that is, the back EMF should

be held at 10 volts, with 15 volts as an upper limit.

In addition to arc suppression across relay contacts is the minimization of electromagnetic interference (EMI). EMI can wreck havoc with RF communications and spark the turn-on of logic gates, SCRs,

and triacs.

Needs Stereo Chips

QI would like to find an inexpensive preamp or integrated amp (20 watts or so) to place in a really nice cabinet that matches some other equipment. I need one that has volume, bass, treble, and balance. They can be separate modules from a number of companies. It seems to me that there used to be a lot of these things around in kit form, but several hours of surfing on the Web proved fruitless. I'm willing to build it from scratch using transistors or ICs.

Bruce Brown via Internet

ANational Semiconductor makes a nice line of power amp ICs called the Overture series. They range in power from 20 to 60 watts and are housed in multi-pin TO-220 plastic packages. The amplifiers are safeguarded at the output against overvoltage, undervoltage, overloads, thermal runaway, and instantaneous temperature peaks. The LM1876 matches your request for a power amp. Figure 3 shows the schematic for the power amp section.

An LM1036 audio preamp — also from National Semiconductor — provides tone, volume, and balance. Figure 4 shows the schematic for the preamp section. A loudness switch has been included to modify the frequency curve as the volume level is changed. Notice that the bass and treble controls act on both channels. If you want separate tone controls for each channel, you will need two LM1036 chips,

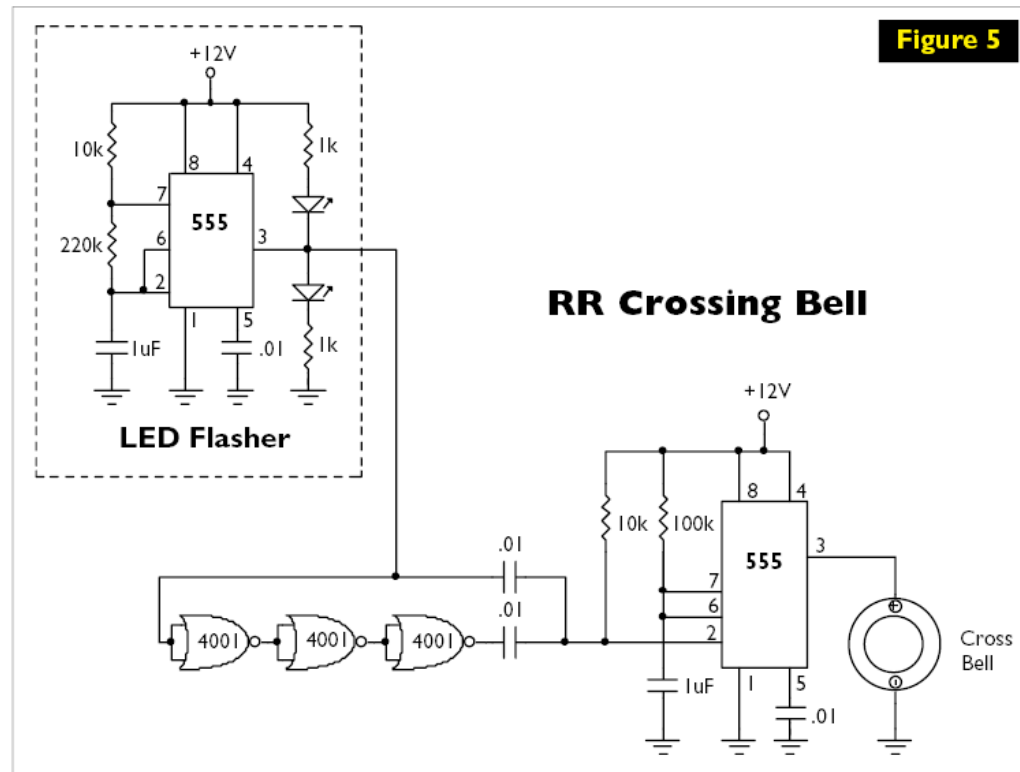

Figure 5

using one channel from each chip for your stereo preamp. The “spare” channels can be used for rear speakers, if you wish.

The power amp requires a +12-volt and a -12-volt power supply — both able to supply four amps of peak current — about three amps average if you use a hefty output capacitor to absorb the peak. A typical power supply can be built using LM350 and LM333 voltage regulators. Although the preamp also runs off +12 volts, it should have its own power supply separate from that of the power amp. An LM78L12 voltage regulator will provide this.

Un-Solder Solder

Q I want to remove and replace a 120-pin IC, but my 30 watt pencil-type iron tends to cause damage to the circuit board and the solder flows between the leads. How does the manufacturer solder all the small surface mount parts with such precision? What type of de-soldering equipment should I use?

**Dave
Reno, NV**

A The manufacturer uses a technique called “reflow soldering” to attach the component to the printed circuit board. It begins by putting a dab of tacky reflow solder on the pads of the circuit board. The component is then placed on the pads, where it is held in place with the solder paste. After all the parts are in place, the board is sent through a “hot box” with a temperature that melts the solder and makes the electrical connections.

To unsolder the part, they often use a reverse process of heating the selected component and its pads to about 350 degrees F for 10 seconds and then lifting it off. Of course, this is way beyond the means (as in money) of the hobbyist. On a smaller scale, the component can be removed using a special solder tip that heats all the pads at once and lifts the part off the board. This, too,

is expensive — plus, each footprint requires a different tip.

The hobbyist solution is something called ChipQuik, a low-temperature solder that replaces the solder holding the chip to the board. ChipQuik solder has a low melting temperature and is very brittle — meaning it crumbles easily. You can buy it from most electronic supply houses, including Jameco (800-831-4242; www.jameco.com). Get a free sample at www.chipquik.com

Model RR Sounds

Q I recently built the LED Flasher from the September 2003 issue and would now like to add the sound of a railroad crossing in sync with the flashing LEDs. Any ideas?

**Oscar Moon, Jr.
via Internet**

A The simple answer is to use the output of the LED Flasher to trigger a one-shot 555 circuit to sound a crossing bell. Search through the RadioShack catalog (www.radioshack.com) for a buzzer with a sound that pleases you. The clinker is that the 555 is negative-going triggered. That is, Pin 2 must be pulled to ground to start the timer. That means, if we tap off, the output of the LED Flasher would chime half the time, skipping the positive-going voltage excursion.

This is easily solved by inserting an inverter in the output and summing the two through 0.01 capacitors. I said an inverter, right? So how come the schematic (Figure 5) shows three NOR gates? This is to put a small delay in the outputs of the inverters so that the capacitor signals don't cancel each other as one is going positive and the other is going negative. I used a series of NOR gates rather than a string of inverters because they have more propagation time and better triggering. If you experience timing problems, add more gates, but just make sure the count is always odd.

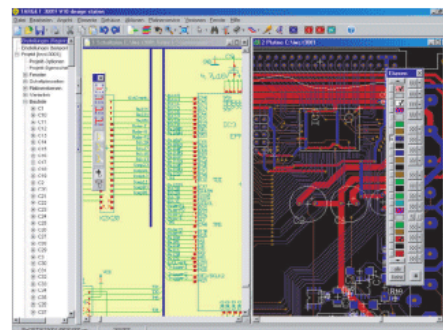

PCB-Layout CAD

- Industrial PCB design as easy as writing letters
- All functions in one program, no conversions
- No patchwork bundle of modules
- No maintenance contracts
- Technical questions answered within 24 h
- 14,000 symbols and corresponding footprints
- Easy drawing of custom components
- Flexible designs, realtime design rule check
- Multilayer technique supported (blind&buried vias)
- Generation of all CAM data for etching and milling
- Lots of automatic functions
- Full featured free demo download at www.target-3001.com

TARGET 3001!

**Starter Kit
TARGET 3001!
"light"
\$59**

**Schematic
PCB
Simulation
Autoplacer
Autorouter
EMC-Analysis
Frontpanel**

Your authorized dealer in the US:



www.deyselectronics.com

phone: (650) 861 0708

eMail: salesus@deyselectronics.com

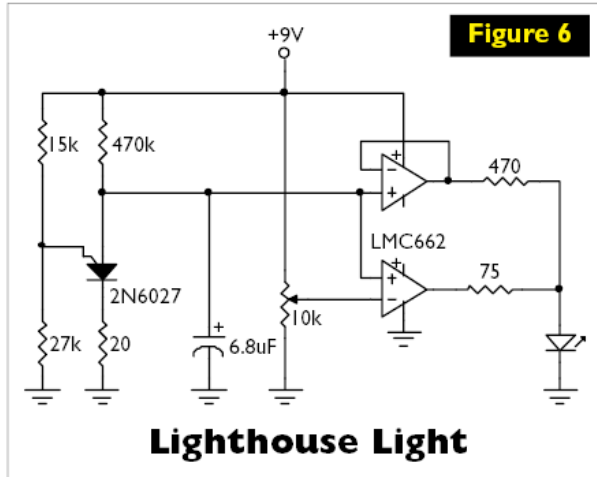

Figure 6

Lighthouse Light

Model RR Lighthouse

Q I saw a circuit that would vary the voltage across a lamp to simulate the beacon of a model lighthouse, but I can't seem to find it in my *large* stack of *Nuts&Volts* (I go back to 1994). Can you point me in the right direction?

Bob J. via Internet

A My stack is just as large as yours and I couldn't find the exact circuit you're talking about, either. So let me give you a new one. In the past, the model for the lighthouse light has been a triangular wave form across a lamp that slowly brightens, then dims to off. Well, that's not exactly the way a lighthouse light works. At the top of the tower is a very bright light that is focused with a fresnel lens to form a beam that stretches out over the ocean, sea, or bay. So what the mariner sees is a bright light ray emanating from a

dimmer source. This beam is often rotated or modulated in Morse code fashion to identify the lighthouse. Whichever means you use, the lighthouse will seldom look like the slow-on, slow-off most models represent. Figure 6 shows a circuit that more closely mimics a light house of the early 1900s.

In this design, two voltages are used to control the brightness of an LED. The first is a rising voltage developed by a sawtooth generator. This voltage is developed by charging a 6.8- μ F capacitor through a 470K resistor. At a voltage set by the 2N6027 programmable unijunction transistor (PUT), the capacitor discharges through the 20-ohm resistor until its charge is drained, at which point, the cycle begins anew.

One of the op-amps is a voltage follower that provides increasing brightness to the LED as the capacitor charges. The second op-amp is used as a comparator whose output goes high when the input voltage exceeds a level set by the 10K pot. What you get is a slowly increasing brightness of the light, followed by a bright flash — as would happen if the light beam were to pass your line of sight. The duration of the bright flash is controlled by the 10K pot. The LED then goes dark and the "sweep" begins again.

Needs LASCR

around somewhere.

Tom Allston Amarillo, TX

A Yep, the LASCR has gone the way of the dodo bird, woolly mammoth, and Richfield gas station. Fortunately, it's easy to make one using a photovoltaic cell or photoresistor. Check out Figure 7 for this discussion. In schematic (b), a photoresistor reacts to light and decreases its resistance as the intensity of the light increases. The sensor should have a dark resistance of greater than one megohm and a light resistance of about one kilohm.

Schematic (a) uses a photovoltaic array to generate enough voltage and current to trigger the SCR. These cells can be salvaged from a solar-powered calculator. This method is best used with sensitive-gate SCRs, and both methods have an advantage over a phototransistor in that they are insensitive to the SCR working voltage.

Easy Split

Q I am interested in taking the eight-ohm external speaker output (monaural) from my Icom radio and connecting it to the stereo (both channels) line input on my powered computer speakers. It's easy to just use a jumper cable, but there is a level and impedance mismatch. All I can come up with is a 1:1 isolation transformer and two 10K resistors to split the signal. Is there a better way?

Paul Frankle via Internet

A This is really simpler than you think. Most powered PC speakers have an input resistance of about 18 ohms and require 400 mV for full volume output. What I've done in the past is use this low-input impedance to my advantage by padding down the output of the receiver with 100 ohm resistors (Figure 8). To realize the full benefit of the new speakers, you may wish to experiment with the

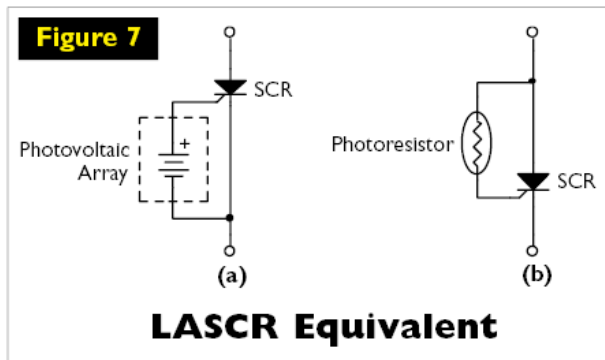

Figure 7

LASCR Equivalent

Q Do you have any idea where I could find light-activated silicon-controlled rectifiers? I have been trying to find a source with no success. I know it's an elderly component — probably no longer in production — but surely there are some left

phasing of the speakers by reversing the polarity of one speaker — exchange the wires on the speaker itself — for maximum clarity and volume.

MAILBAG

Dear TJ,

In your January 2005 Mailbag, Charles Geillker wrote to correct you concerning “putting 12 amps through a one-ohm resistor” to produce 144 watts, as opposed to 10 watts. He is, of course, correct. Your comment “It’s called duty cycle” seemed a bit condescending. What is really going on is that the energy being absorbed by the resistor is a function of both the power (watts) and the duty cycle (time). The 10-watt resistor may be just fine at the proposed duty cycle, but it’s still dissipating 144 watts while the current is applied. The energy is the amount of

heat the resistor must tolerate. Energy is integral of power with respect to time.

**Tom Barton
via Internet**

Dear TJ,

I noticed that I am constantly scanning your magazine for new chips (that is, new to me) and it crossed my mind that I could ask you to make a practice of pointing out “neat” chips. Please feel free to

exhort your latest or favorite discoveries in the integrated chip area, even if you don’t have a project to go with them at the moment.

**Chuck
via Internet**

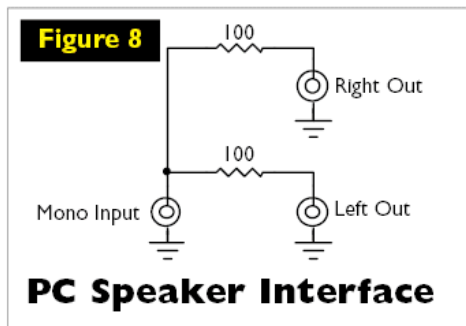

Cool Websites!

Got a beef with your bank, but can't get past the voice mail? Here's how to bypass the menus and get to a live person.

www.quickbase.com/db/85vqhz4a?a=q&qid=5

Think you know the states of the union? Take this third-grade test and prepare to be surprised. Thanks, Steve!

http://snipurl.com/map_test

Here's a more sophisticated — and challenging — geography mapping test.

<http://snipurl.com/maptest>

Surplus Sales of Nebraska

SPECTX 100™ Surge Protected Energy Center and Transfer Switch (ELE) TSM-100



\$495

- NEMA 3R Enclosure (34"W x 20 1/4"H x 8"D)
- Mechanically Interlocked MTS (Walking Beam)
- Surge Blox™ Suppression System
- LEDs / Alarms
- GFI Receptacle Outlet
- 100 Amp Manual Transfer Switch
- 30 Amp Generator Inputs
- Original OEM cost \$3,000
- Made by Data Systems / Electric Equipment and Engineering

For home or commercial use, the reduced footprint SPECTX 100™ maximizes space and installation time. Combining four panels into one optimizes service distribution while providing superior power protection.

The SPECTX 100™ provides more usable wall space in cabinets, shelters, businesses and homes. Quality and dependability are built in whether the transfer system supplies telephone power plants, UPS equipment, computers, other critical loads or electronics in residences and office complexes.

Please visit our website with over 2,000 pages and 10,000 images • www.surplussales.com



Power Supplies: Low Voltage, High Voltage, Lighting, Precision.



Teflon® Wire: From 10 gauge to 26 gauge



Heatsinks: All Sizes and Shapes. Large Quantities for Manufacturers



Piston Trimmers: HiQ, Differential, LC Tuners. Over 100 styles and ranges.



Fingerstock: Over 20 styles and sizes



HI Manuals: 1,000s of radio, military and test equipment manuals on hand!!



Fujitsu Pen Computers



Motors & Pumps: Synchronous, gear reduction, projector motors, etc.



Transformers: High & Low voltage, chokes.



Variable Capacitors: Air - Mica - Vacuum



Vacuum Tubes: Over 1,000,000 vacuum tubes in stock!!



Variacs: From 3 amps to 245 amps.



Coaxial Relays: Many power levels HF to Microwave.



Potentiometers: Wire Wound and Carbon, Shafted and Screwdriver adjust.



High Impact Shipping Containers

1502 Jones Street, Omaha, NE 68102 • Fax: 402-346-2939 • e-mail: grinnell@surplussales.com • Visa, Mastercard, American Express or Discover
Call or e-mail for shipping and total charges. All SPECIALS in this Ad only good for 30 day advertising cycle. No exceptions please.

Visit our website @ www.surplussales.com **800-244-4567 • 402-346-4750**

Advanced Techniques for Design Engineers

The Design Cycle

A PIC-based Wi-Fi Development Platform

Does that new laptop of yours have built-in wireless Ethernet local area network (LAN) capability? How about that new portable digital assistant (PDA) you just purchased? Does it have wireless Ethernet LAN capability, too? It seems that everything these days is wireless — except the things that you really want to be wireless.

We've all come to take cell phones for granted and wireless hand-held email devices are becoming more prevalent. The problem is that there is nothing commercially available to easily and inexpensively enable the unique microcontroller-based gadgets that we all build for ourselves to work on a wireless network.

For instance, wouldn't it be cool to have wireless LAN communications functionality built into your model railroad system? How about little wireless 802.11b nodes all over the place in your home, monitoring and controlling whatever you want

them to under the ultimate control of your wireless laptop or Ethernet-capable desktop?

A universal serial bus (USB) is a beautiful thing, but aren't you tired of running communications cables between your personal computer serial, USB, and Ethernet ports and your supposed "remote-controlled" gadgets? Imagine if you could use wireless LAN technology to control and monitor one of your gadgets remotely from that wireless LAN-equipped laptop you own or from the hard-wired desktop computer in the den. Dreams do come true because, in this month's column, I'm going to give you all of the tools necessary to incorporate 802.11b wireless technology into your next Programmable Interrupt Controller (PIC) project.

AirDrop-P

So, let's begin by designing and fabricating some basic PIC-based 802.11b hardware. Our 802.11b wireless LAN discussion will be based on the AirDrop-P hardware you see in Figure 1. The "P" in AirDrop-P stands for PIC, and it is a very simple device that is based on one of Microchip's high-pin-count PICs, the PIC18LF8621.

Not only does the PIC18LF8621 have lots of available input/output (I/O), it is loaded with static random access memory (SRAM) and program Flash to boot. The PIC18LF8621 is composed of 64K of program Flash and a little over three kilo-

bytes of SRAM. If you need EEPROM area, the PIC18LF8621 is equipped with one kilobyte of on-chip EEPROM. There are 69 I/O lines, a 10-bit analog-to-digital converter, two enhanced USARTs, five timers, an SPI module, and an I²C module on-chip. That's more than enough resources needed to bring our AirDrop-P to life on a wireless LAN. Follow along with Figure 2 as I describe the AirDrop-P hardware design.

Let's start with the power supply. There's nothing here you haven't seen before. A National Semiconductor LM1086CS-3.3 linear regulator supplies the 3.3-volt power rail for the 802.11b radio, the Sipex SP3232 RS-232 converter, and the PIC18LF8621 microcontroller. Any six-to-nine-VDC, center-positive wall wart that can deliver 400 mA is suitable for powering the AirDrop-P. An industry standard switching diode (D2) makes sure that negative-center power bricks won't destroy the AirDrop-P circuitry with reverse polarity power. Filtering the AirDrop-P's 3.3-volt power supply is simple and is done with a couple of 10- μ F tantalum capacitors.

A standard RS-232 serial port is provided by the inclusion of the 3.3-volt Sipex SP3232 RS-232 converter. Capacitors C4 through C7 enable the SP3232's on-chip charge pump while C8 is a standard power supply bypass capacitor for the SP3232. The SP3232 is capable of driving two pairs of RS-232 transmit and receive lines. Just in case handshaking is desired, the second pair of transmit and receive lines is dedicated to RTS/CTS handshaking duty. The AirDrop-P's RS-232 nine-pin D-shell

Figure 1. Everything you need to succeed with 802.11b is on this board. The 802.11b AirDrop-P hardware is simple and straightforward, and the firmware support is growing day by day. You don't need any special tools to make the AirDrop function. All you need are the basic Microchip support tools for the PIC18LF8621, an MPLAB ICD2, and a PIC C-compiler.

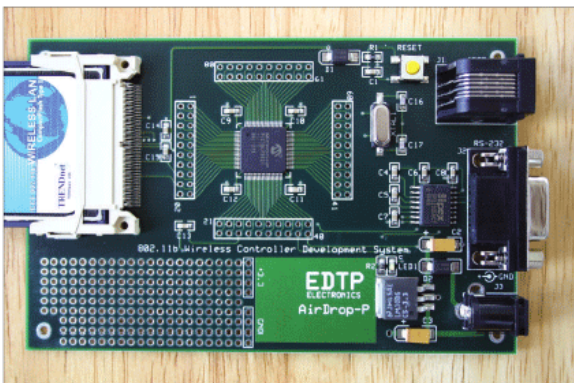

connector is wired as data communications equipment (DCE) to eliminate the need for a crossover serial cable or null modem when connecting to data terminal equipment (DTE) devices like your personal computer's serial ports.

You may wonder why a serial port would be something necessary to have on an 802.11b wireless device. Well, it's not really necessary, but it was great to have when I was writing and debugging the 802.11b driver code. It's a nice luxury to have when you want to mark places in the code that "talk back" using the serial port during normal 802.11b wireless operation. It's also good to have serial ports when writing columns like this, as you can dump data to a termi-

nal emulator and physically see what is going into and coming out of the AirDrop-P.

Let's move on to the microcontroller. The PIC18LF8621 is the low-voltage, lower power cousin of the PIC18F8621. Both the PIC18LF8621 and the PIC18F8621 are capable of operating with a maximum clock frequency of 40 MHz with a Vdd of +5.5 VDC. However, the AirDrop-P is powered with a 3.3-VDC power supply and the PIC18LF8621's maximum clock frequency is reduced to a bit over 25 MHz. Here's the PIC18LF8621 maximum clock frequency versus maximum applied Vdd equation:

$$F_{max} = (16.36 \text{ MHz/V}) (V_{ddappmin} - 2.0 \text{ V}) + 4 \text{ MHz}$$

$$- 2.0 \text{ V}) + 4 \text{ MHz}$$

where:

F_{max} = Maximum operating clock frequency

$V_{ddappmin}$ = Minimum Vdd power supply voltage

$$F_{max} = (16.36 \text{ MHz/V}) (3.3 \text{ V} - 2.0 \text{ V}) + 4 \text{ MHz} = 25.268 \text{ MHz}$$

To guarantee stability, I decided to run the AirDrop-P clock at 20 MHz. If you can handle changing the CompactFlash card's mandatory I/O delays, you can run your AirDrop-P at the clock rate ceiling if you desire.

The PIC18LF8621 ICSP programming interface is standard Microchip issue. The AirDrop-P is designed to be programmed and debugged easily

Figure 2. The AirDrop-P hardware design.

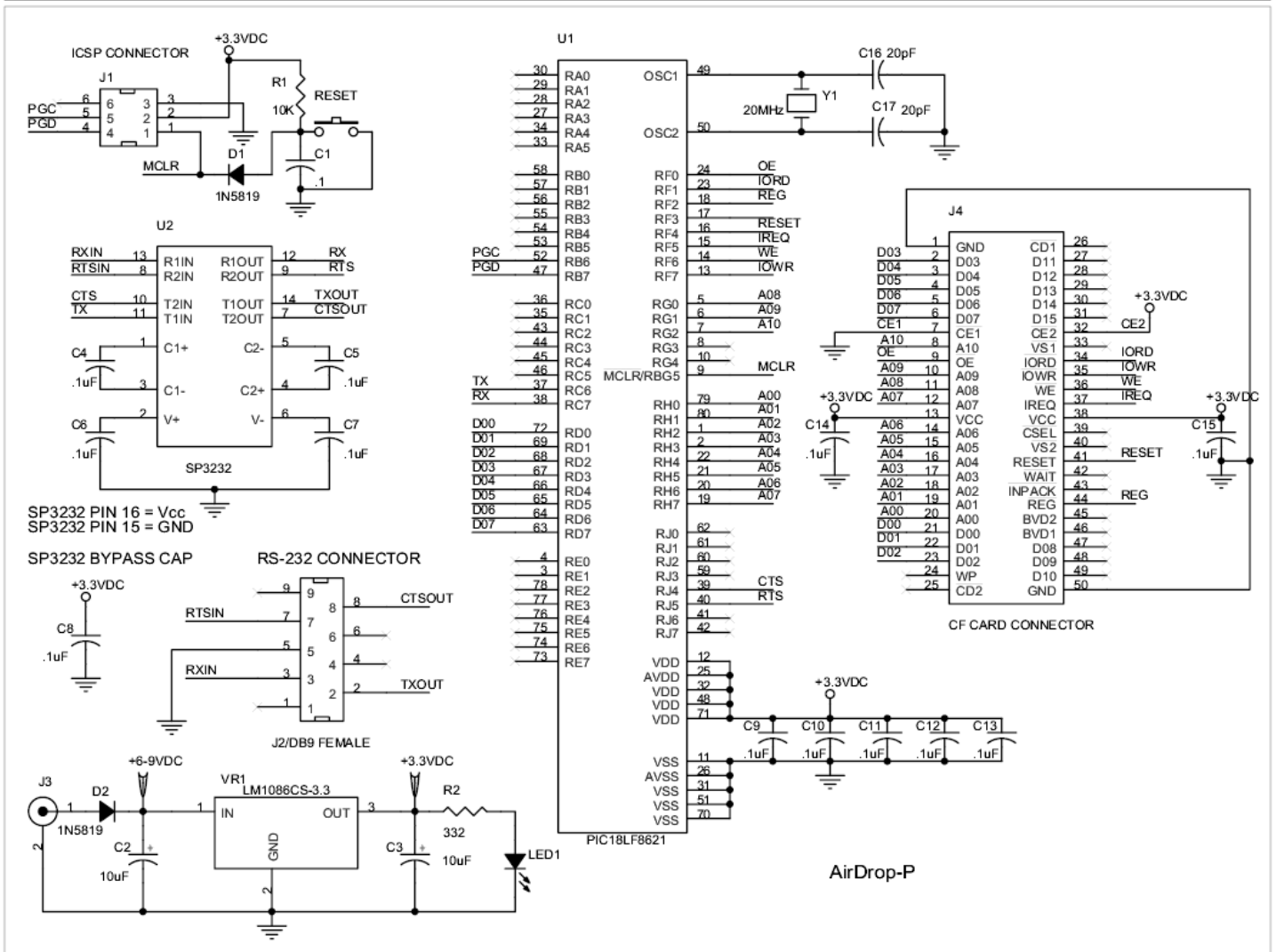

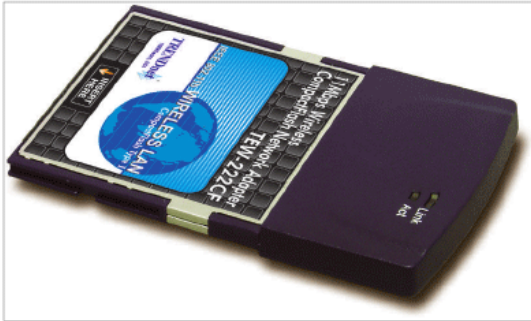

Figure 3. This card was chosen for the AirDrop-P series because of its descriptive and easy-to-understand LED modes and its internal PRISM chipset.

using the MPLAB ICD2 in combination with the latest version of Microchip's MPLAB IDE. Any Microchip-compatible programming/debugging system can be used to enable the AirDrop-P.

The business end of the AirDrop-P is the 50-pin CompactFlash connector that carries the 802.11b wireless LAN network interface card and interfaces the CompactFlash

card's electronics to the PIC18LF8621. Since the PIC18LF8621 is an eight-bit microcontroller, the 16-bit amenities of the CompactFlash connector are unused and thus not connected. To save PIC18LF8621 I/O, only the CompactFlash connector I/O lines that are absolutely necessary for 802.11b operation are connected and used. For instance, the CD1 and CD2 pins are used to determine if a card is mounted correctly. Those pins are left disconnected, as we

most likely won't be hot swapping 802.11b CompactFlash cards, and writing code to sense these pins would be a waste in our particular application of the CompactFlash card.

A memory-mapped approach to driving the AirDrop-P was considered. However, to keep the circuitry and driver code as simple as possible, a simple I/O interface was adopted. Note that there is absolutely no "glue" logic on the AirDrop-P board. One of the AirDrop-P design points was to leave as many of the PIC18LF8621's subsystems open for use and to leave as many microcontroller I/O lines open as possible without resorting to additional special purpose components. Also, using the I/O interface allowed the use of simple I/O code routines to move data back and forth between the CompactFlash card and the PIC18LF8621.

All of the firmware to drive our 802.11b application and the CompactFlash network interface card (NIC) is contained within the PIC18LF8621's Flash program. The CompactFlash NIC is responsible for taking the data we give to it and broadcasting it wirelessly to another wireless station or access point. The wireless LAN card of choice for the AirDrop series of 802.11b development systems is manufactured by TRENDnet and is shown in Figure 3. The TRENDnet TEW-

Listing 1. Here's a bit of code that fires up the TRENDnet TEW-222CF wireless LAN CompactFlash card. There is a lot of information here. Fortunately, we only need just a few bytes of it to get our wireless project off the ground.

```
void init_cf_card(void)
{
    //***** LOCAL DEFINITIONS
    char cor_addr_lo, cor_addr_hi, cor_data;
    char cis_device;
    unsigned int cis_addr, x;           // attribute memory index (EVEN ADDRS ONLY)
    char code_tuple;                   // tuple type
    char link_tuple;                   // number of body bytes in this particular tuple
    char tuple_link_cnt;
    char tuple_data;                  // current body, byte value for a given body
    char funce_cnt;                   // there are 6 & the 4th holds the MAC addr
    char mac_cnt;
    char rc;
    //***** END LOCAL DEFINITIONS

    //***** BEGIN CONTACT CF CARD
    set_RSET;
    SETUP_A;
    SETUP_C;
    SETUP_F;
    SETUP_G;
    SETUP_H;
    SETUP_J;
    FROM_NIC;
    clr_RSET;
    clrf_cis;
    x = 500;                           //set up a time out timer
    do{
        delay_ms(2);
        if(-x == 0)
        {
            break;
        }
        code_tuple = rd_code_tuple(0x0000);
        if(code_tuple == 1)
            setf_cis;
    }while(!(bcisflag));
    //***** END CONTACT CF CARD

    cis_device = 0;
    cor_addr = 0;
    funce_cnt = 0;                       // reset to the first CF_CISTPL_FUNCE
    mac_cnt = 0;
    cis_addr = 0;                       // CIS starts at location 0 of Attribute memory
    clrf_cis;

    do{
        code_tuple = rd_code_tuple(cis_addr);
        cis_addr+=2;
        link_tuple = rd_link_tuple(cis_addr);
        cis_addr+=2;

        if(code_tuple != END_TUPLE)
        {
            for(tuple_link_cnt=0; tuple_link_cnt<link_tuple; ++tuple_link_cnt)
            {
                tuple_data = rd_tuple_data(cis_addr);
                cis_addr+=2;
            }
        }
    }
}
```

222CF is an 11-Mbps wireless CompactFlash network adapter card that can transmit and receive up to 60 meters indoors and up to 250 meters outdoors. I particularly like the TRENDnet card because it has an activity LED that lets you know if something is being sent or received by the TRENDnet CompactFlash NIC. Also, the TRENDnet TEW-222CF is certified for use anywhere in the world.

The AirDrop-P is pretty much a “doorbell” microcontroller circuit. The real power behind the AirDrop-P lies in the firmware, so let’s take a look at some of the 802.11b driver code.

802.11b Logic

Before we can do anything with 802.11b, we must first introduce some CompactFlash card lingo. Some of the 802.11b startup information we need and information about the CompactFlash NIC itself can be obtained by simply reading the CompactFlash card’s tuples, which are located in the CompactFlash card’s ROM beginning at address 0x0000 of the CompactFlash card’s attribute memory area.

As far as CompactFlash cards are concerned, a tuple is simply an ordered set of data elements. Tuple elements for any CompactFlash card consist of the code tuple, the link tuple, and the data tuple or data tuples that follow. In a CompactFlash card, the tuple values that are meaningful to us all lie on even byte boundaries. For instance, the first code tuple is at location 0x0000 and the first link tuple is at location 0x0002. This puts the first data tuple at address 0x0004. The reasoning behind this is that only the

Listing 1 continued ...

```
switch(code_tuple)
{
  case DEVICE_TUPLE:
    printf("\r\nDEVICE_TUPLE %02X = %02X",tuple_link_cnt,tuple_data);
    break;
  case DEVICE_A_TUPLE:
    printf("\r\nDEVICE_A_TUPLE %02X = %02X",tuple_link_cnt,tuple_data);
    break;
  case DEVICE_OC_TUPLE:
    printf("\r\nDEVICE_OC_TUPLE %02X = %02X",tuple_link_cnt,tuple_data);
    break;
  case DEVICE_OA_TUPLE:
    printf("\r\nDEVICE_OA_TUPLE %02X = %02X",tuple_link_cnt,tuple_data);
    break;
  case VERS_1_TUPLE:
    printf("\r\nVERS_1_TUPLE_TUPLE %02X = %c",tuple_link_cnt,tuple_data);
    break;
  case MANFID_TUPLE:
    printf("\r\nMANFID_TUPLE %02X = %02X",tuple_link_cnt,tuple_data);
    break;
  case FUNCID_TUPLE:
    printf("\r\nFUNCID_TUPLE %02X = %02X",tuple_link_cnt,tuple_data);
    if(tuple_link_cnt == 0)
      cis_device = tuple_data;
    break;
  case FUNCE_TUPLE:
    printf("\r\nFUNCE_TUPLE %02X = %02X",tuple_link_cnt,tuple_data);
    if(funce_cnt == 4)
      if(tuple_link_cnt>1)
        macaddrc[mac_cnt++] = tuple_data;
    if(tuple_link_cnt == (link_tuple-1))
      funce_cnt++;
    break;
  case CONFIG_TUPLE:
    printf("\r\nCONFIG_TUPLE %02X = %02X",tuple_link_cnt,tuple_data);
    if(tuple_link_cnt == 2)
      cor_addr_lo = tuple_data; // copying low-byte
    if(tuple_link_cnt == 3) // shift, then copy hi-byte
      {
        cor_addr_hi = tuple_data;
        cor_addr = make16(cor_addr_hi,cor_addr_lo);
      }
    break;
  case CFTABLE_ENTRY_TUPLE:
    printf("\r\nCFTABLE_ENTRY_TUPLE %02X = %02X",tuple_link_cnt,tuple_data);
    break;
  default:
    break;
} // end switch
} // end for loop tuple_link_cnt
} //if(code_tuple != END_TUPLE)
else
  {
    setf_cis;
  }
}while(!(bcisflag));

cor_data = rd_cor_data(cor_addr);
delay_ms(4);
cor_data |= io_en_mask;
wr_cor_data(cor_data,cor_addr);

rc = send_command( Initialize_Cmd, 0);
switch(rc)
{
  case 0:
    printf("\r\nAirDrop-P Initialized");
    break;
  case 1:
    printf("\r\nAirDrop-P Initialization Failure");
    break;
  case 2:
    printf("\r\nNo buffer space");
    break;
  case 3:
    printf("\r\nCommand error");
    break;
  default:
    printf("\r\nResult Code = %x",rc);
    break;
}
}
```

Listing 2. Each and every one of these bytes has a purpose. I turned on ASCII translation instead of hex translation for the VERS_1_TUPLE output.

```

DEVICE_TUPLE 00 = 00
DEVICE_TUPLE 01 = 00
DEVICE_TUPLE 02 = FF
DEVICE_A_TUPLE 00 = 67
DEVICE_A_TUPLE 01 = 5A
DEVICE_A_TUPLE 02 = 08
DEVICE_A_TUPLE 03 = FF
DEVICE_OA_TUPLE 00 = 01
DEVICE_OA_TUPLE 01 = 67
DEVICE_OA_TUPLE 02 = 5A
DEVICE_OA_TUPLE 03 = 08
DEVICE_OA_TUPLE 04 = FF
VERS_1_TUPLE 00 =
VERS_1_TUPLE 01 =
VERS_1_TUPLE 02 = W
VERS_1_TUPLE 03 = i
VERS_1_TUPLE 04 = r
VERS_1_TUPLE 05 = e
VERS_1_TUPLE 06 = l
VERS_1_TUPLE 07 = e
VERS_1_TUPLE 08 = s
VERS_1_TUPLE 09 = s
VERS_1_TUPLE 0A =
VERS_1_TUPLE 0B = L
VERS_1_TUPLE 0C = A
VERS_1_TUPLE 0D = N
VERS_1_TUPLE 0E =
VERS_1_TUPLE 0F = A
VERS_1_TUPLE 10 = d
VERS_1_TUPLE 11 = a
VERS_1_TUPLE 12 = p
VERS_1_TUPLE 13 = t
VERS_1_TUPLE 14 = e
VERS_1_TUPLE 15 = r
VERS_1_TUPLE 16 =
VERS_1_TUPLE 17 = V
VERS_1_TUPLE 18 = e
VERS_1_TUPLE 19 = r
VERS_1_TUPLE 1A = s
VERS_1_TUPLE 1B = i
VERS_1_TUPLE 1C = o
VERS_1_TUPLE 1D = n
VERS_1_TUPLE 1E =
VERS_1_TUPLE 1F = 0
VERS_1_TUPLE 20 = 1
VERS_1_TUPLE 21 = .
VERS_1_TUPLE 22 = 0
VERS_1_TUPLE 23 = 2
VERS_1_TUPLE 24 =
VERS_1_TUPLE 25 =
VERS_1_TUPLE 26 = y
MANFID_TUPLE 00 = 56
MANFID_TUPLE 01 = 01
MANFID_TUPLE 02 = 02
MANFID_TUPLE 03 = 00
FUNCID_TUPLE 00 = 06
FUNCID_TUPLE 01 = 00
FUNCE_TUPLE 00 = 01
FUNCE_TUPLE 01 = 07
FUNCE_TUPLE 02 = 02
FUNCE_TUPLE 03 = 0F
FUNCE_TUPLE 04 = 00
FUNCE_TUPLE 05 = 02
FUNCE_TUPLE 06 = D5
FUNCE_TUPLE 07 = 19
FUNCE_TUPLE 08 = 36
FUNCE_TUPLE 09 = 36
FUNCE_TUPLE 0A = 05
FUNCE_TUPLE 0B = 46
FUNCE_TUPLE 0C = 7F
FUNCE_TUPLE 0D = FF
FUNCE_TUPLE 0E = FF

```

lower eight bits of the CompactFlash card's 16-bit data bus are exposed, which happen to be the even-numbered bytes. This allows eight-bit devices easy access to the read-only CompactFlash's card information structure (CIS) area where the eight-bit, even-numbered-spaced tuples live.

Tuples are arranged in the CompactFlash's CIS area as a linked list. The code tuple describes the type of tuple that is being accessed with each tuple's code name being defined in the CompactFlash standards documentation. The link tuple tells us how many bytes are remaining within the tuple. So, the drill is to parse the number of data tuples from the first tuple to the next and so forth.

That's enough tuple talk. Instead of pounding out words and definitions about a tuple, what it does, and where it sits in the CompactFlash card CIS, let's follow through some real working code that traverses the linked list of tuples found within the TRENDnet 802.11b wireless LAN CompactFlash card we're using on the AirDrop-P.

Listing 1 is a code snippet from the AirDrop-P 802.11b driver. Don't concern yourself with some of the

more mundane functions — like SETUP_A — as these are just macros that set the TRIS values of the PIC18LF8621's I/O pins. If there's a function you need to know about that concerns the CIS parsing, I'll make sure to stop and talk about it along the way. Otherwise, it will most likely be obvious to you as you pour through the full 802.11b driver code listing.

The main reason that the code in Listing 1 exists is to determine the main read/write I/O portal address for the TRENDnet CompactFlash card's configuration registers. The standard CompactFlash card and PCMCIA configuration register I/O address are usually located at 0x03E0. However, assumptions are not always good things and it's easy enough to determine the actual configuration register I/O address by parsing the CIS bytes. Running through the parsing exercise is also a good way to determine if we're really talking to the TRENDnet CompactFlash card's internals.

The very beginning of the function `init_cf_card(void)` consists of the declaration of all of the local variables that will be used in the CIS parsing operation. The 16-bit configuration register address will be assembled from the `cor_addr_lo` and `cor_addr_hi` bytes. The next logical step we must take is to make sure that the CompactFlash card is properly reset and that our PIC18LF8621 I/O is initialized correctly. The `set_RSET` and `clr_RSET` macros operate on the CompactFlash card's RESET I/O pin. The `FROM_NIC` and `TO_NIC` macros simply TRIS the PIC18LF8621's data bus I/O pins for input and output operations, respectively. All of these routines are simple I/O routines you write and execute everyday if you're a human PIC programmer.

Once the initialization of the CompactFlash card and PIC I/O pins is complete, a simple software timer/reader routine is kicked off that tries to read the code tuple value at CIS location 0x0000 for one second. Since the TRENDnet

Listing 2 continued ...

```

FUNCE_TUPLE 03 = E0
FUNCE_TUPLE 04 = 98
FUNCE_TUPLE 05 = C8
FUNCE_TUPLE 06 = DA
FUNCE_TUPLE 07 = 2B
FUNCE_TUPLE 08 = 05
FUNCE_TUPLE 09 = 01
CONFIG_TUPLE 00 = 03
CONFIG_TUPLE 01 = 01
CONFIG_TUPLE 02 = E0
CONFIG_TUPLE 03 = 03
CONFIG_TUPLE 04 = 00
CONFIG_TUPLE 05 = 00
CONFIG_TUPLE 06 = 01
CFTABLE_ENTRY_TUPLE 00 = C1
CFTABLE_ENTRY_TUPLE 01 = 01
CFTABLE_ENTRY_TUPLE 02 = 19
CFTABLE_ENTRY_TUPLE 03 = 76
CFTABLE_ENTRY_TUPLE 04 = C5
CFTABLE_ENTRY_TUPLE 05 = 4B
CFTABLE_ENTRY_TUPLE 06 = D5
CFTABLE_ENTRY_TUPLE 07 = 19
CFTABLE_ENTRY_TUPLE 08 = 36
CFTABLE_ENTRY_TUPLE 09 = 36
CFTABLE_ENTRY_TUPLE 0A = 05
CFTABLE_ENTRY_TUPLE 0B = 46
CFTABLE_ENTRY_TUPLE 0C = 7F
CFTABLE_ENTRY_TUPLE 0D = FF
CFTABLE_ENTRY_TUPLE 0E = FF

```

CompactFlash NIC is not a memory card or hard disk card, the first code tuple should define the CompactFlash card as a null device, which is designated by a numeric value of 1. If the initial tuple read is a success, the CompactFlash card has initialized properly and we can move on and determine where the configuration register I/O portal is located.

Listing 2 is the resultant CIS tuple dump of the TRENDnet TEW-222CF CompactFlash card. There are lots of things exposed here that require super secret PRISM documentation to interpret. If you're curious, I suggest looking over the many Linux Internet posts on the subject of wireless NIC tuples. For now, we're really only interested in Data Bytes 2 and 3 of the CONFIG_TUPLE, which collectively contain our configuration register I/O address. You can see in Listing 1 how the configuration register I/O address of 0x03E0 was realized.

At this point in the code, the Link LED on the TEW-222CF mounted in the AirDrop-P CompactFlash card socket is glowing solid. We've done nothing to activate any of the TEW-222CF's 802.11b circuitry up to now, other than perform a CompactFlash card reset. The solid glow of the TEW-222CF Link LED signals that the TEW-222CF has successfully performed a reset operation and is ready to be initialized. After issuing the CompactFlash card's initialize command, the TEW-222CF's Link LED starts to blink, indicating that the CompactFlash card is initialized and ready to receive further instructions.

There are certain things that you must know to be able to continue. First, will your AirDrop-P be participating in an infrastructure network or will it operate in *ad hoc* mode? An infrastructure basic service set (BSS) network implies that some type of wireless access point is operating in the network. For most of you, the wireless access point also doubles as a router and a gateway to the Internet via your DSL or broadband connection. An example of a home wireless access point is the basic Netgear

MR814. *Ad hoc* independent basic service set (IBBS) networks are simple point-to-point wireless connections between wireless stations that do not have an access point in their network structure.

The basic 802.11b driver code I'm providing for you has no provision to automatically get an IP address from a dynamic host configuration protocol (DHCP) server. In this instance, you'll also need to designate a suitable Internet provider address for the AirDrop-P that is interoperable with your network. An

upside to using CompactFlash card NICs is that each one has a unique hardware media access controller (MAC) address burned into its ROM. The CompactFlash card's hardware address can be had by simply copying it from the back of the CompactFlash NIC or electronically via a call from the AirDrop-P's 802.11b driver.

Let's check off our wireless LAN parameter shopping list items with a walk through the code you see in Listing 3. The code snippet in Listing 3 is the sequence of events that

Listing 3. This code snippet shows the flow of the calls to the AirDrop-P 802.11b driver that are needed to put the TRENDnet TEW-222CF on the air and to contact and communicate with other stations on a wireless LAN.

```
void main(void)
{
    unsigned int i,temp,evstat_data;
    char rc;

    init_USART();
    init_cf_card();

    airdrop_config(BSS);
    airdrop_config(SSID);

    /* BEGIN...ESTABLISH MAC ADDRESS AND IP ADDRESS
    temp = r_read(0xFC01);
    for(i=0;i<6;i++)
    {
        if(i%2)
            macaddrc[i] = fr_buffer[2+i/2]>>8;
        else
            macaddrc[i] = fr_buffer[2+i/2]& 0xFF;
    }
    for(i=0;i<3;++i)
    macaddri[i] = fr_buffer[i+2];
    ipaddri[0] = make16(ipaddrc[1],ipaddrc[0]);
    ipaddri[1] = make16(ipaddrc[3],ipaddrc[2]);
    /* END...ESTABLISH MAC ADDRESS AND IP ADDRESS

    /* BEGIN...ENABLE NIC

    allocate_xmit_buffers();
    wr_cf_io16(0xFFFF, 0x0034);
    if(rc=send_command(0x0001,0))
        printf("MAC Enable Error\r\n");
    do{
        temp=r_read(0xFD40);
        }while(fr_buffer[2]!=4);
    temp = r_read(0xFD42);
    for(i=0;i<6;i++)
    {
        if(i%2)
            bssidc[i] = fr_buffer[2+i/2]>>8;
        else
            bssidc[i] = fr_buffer[2+i/2]& 0xFF;
    }
    for(i=0;i<3;++i)
    bssidi[i] = fr_buffer[i+2];
    /* END...ENABLE NIC

    /* BEGIN...DO YOUR DUTY
    while(1){
        do{
            evstat_data = rd_cf_io16(0x0030);
            }while(!(evstat_data & 0x0001));
            get_airdrop_frame();
        }
    }
```

results in putting the TRENDnet TEW-222CF wireless LAN CompactFlash card on the air.

We've already discussed the `init_USART` and `init_cf_card` functions. The fun begins with the call to `airdrop_config(BSS)`. This tells the TEW-222CF that we want to participate in an infrastructure network (BSS) and ultimately associate with an access point. The next call to `airdrop_config(SSID)` is optional. A string can be defined with the name of the particular network (BSS) you would like to join. The service set identifier (SSID) is a 32-character identifier that you assign to your access point/router and is used to differentiate one wireless LAN from another. For instance, my lab wireless LAN has an SSID of "EDTP." To join the EDTP BSS, I must code the AirDrop-P 802.11b driver in the appropriate location as follows:

```
char tempstring[] = "EDTP";  
//Your desired SSID here
```

By leaving the string null (" instead of "EDTP"), the first available BSS will be selected by the TEW-222CF CompactFlash NIC for association and connection.

The TRENDnet TEW-222CF Link LED is still flashing at this point, indicating that we are still in the setup process and haven't made any real attempts to get on the air. The next items we need to check off of our shopping list are the MAC and IP addresses for the wireless NIC. The TRENDnet TEW-222CF's MAC address is garnered electronically via an 802.11b driver call, and the IP address is defined inside the 802.11b driver code as follows:

```
char ipaddr[4] = { 192,168,0,151 };
```

The downside of just copying the CompactFlash card's MAC address and hand coding it in is that, if you change CompactFlash cards, you'll have to reenter the new MAC address manually.

We're just about to enter the EDTP access point's air space. The next set of function calls in Listing 3 turn on the 802.11b radio and send probe messages out into the ether. The TEW-222CF is actually "fishing" at this point. The TEW-222CF's Activity LED is flashing as data is passed from the now active TEW-222CF NIC to any access point in the range of the TEW-222CF's probing

radio signal. If everything we've done this far was correct, in less than a second the TEW-222CF's Activity LED will flicker and extinguish and the TEW-222CF's Link LED will glow steadily. This indicates that the AirDrop-P has contacted an access point and gotten a response from the access point, telling it who the access point is and what capabilities the access point has.

The AirDrop-P then associates with the selected access point (in our case, the "EDTP" access point), authenticates itself with the access point — if necessary — and joins the EDTP access point's BSS. The AirDrop-P can now send and receive meaningful data on the wireless LAN with the help of the EDTP access point.

Leaving the (Air)Drop Zone

Now that a wireless communications channel has been established, the AirDrop-P can communicate with other Ethernet devices on the wireless LAN and wired LAN segment, using standard Internet protocols.

The wireless LAN world is very secretive on the outside; however, you can use the basic 802.11b driver code I've provided in conjunction with open source 802.11b Linux examples from the Internet to gain enough knowledge (and operational code) to easily put an AirDrop-P on your local Ethernet LAN. There's also a dedicated Internet user group for those of you that are interested in sharing AirDrop-P experiences and source code. If you're the least bit interested in wireless LAN communications with microcontrollers, I highly suggest monitoring the AirDrop-P user group's chatter. **NV**

To Access the AirDrop-P User Group

Group name: `airdrop_user`
Group home page:
http://groups.yahoo.com/group/airdrop_user
Group email address:
airdrop_user@yahoogroups.com

It writes your USB code!

NO Need to be a USB expert!

HIDmaker (\$399) – creates ready to compile PC & PIC programs that talk to each other over USB.

Choose your favorite languages!

PIC: Pic Basic Pro, CCS C, Hi-Tech C, MPASM. **PC:** VB6, Delphi, C++ Builder. **Single chip solution:** PIC with built-in USB

HIDmaker Test Suite (\$149)

USBWatch – shows your device's USB traffic, even during 'enumeration', without expensive equipment.

AnyHID – Test any USB HID device.

See what data it sends, even what the data is used for.



301-262-0300

WWW.TraceSystemsInc.com

NEW Catalog Out Now



FREE
400+ page
Catalog

Get Your **FREE US\$ Priced Catalog** - all 400+ pages!

Just fill out the catalog request form at www.jaycarelectronics.com/catalog

Check our website!

- All of our 6,000+ products with search facilities.
- 128-bit secure on-line ordering - safe & secure.
- Over 3,500 product datasheets & application notes.
- And we're from Australia, so you can trust us!
- Postage and Packing includes airmail to the USA



Moreinfo?

www.jaycarelectronics.com

Post and Packing Charges:	
Order Value Cost	
\$25 - \$49.99	\$7.50
\$50 - \$99.99	\$20
\$100 - \$199.99	\$40
\$200 - \$499.99	\$60
\$500+	\$75
Max weight 12lb (5kg) - heavier parcels POA. Minimum order \$25.	

Performance Electronics for Cars Book

BS-5080 \$13.60 + post & packing

Australia's leading electronics magazine, Silicon Chip, has developed a range of projects for performance cars. There are 16 projects in total, ranging from devices for remapping fuel curves, to nitrous controllers, and more! The book includes all instructions, components lists, colour pictures, and circuit layouts. There are also chapters on engine management, advanced systems, DIY modifications, and more. Over 150 pages! All of the projects described are available in kit form, exclusively from Jaycar. Check out our website for all the details.

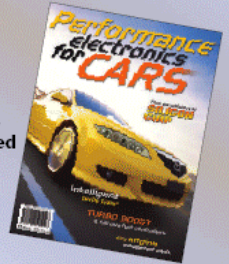

JUST ONE OF OUR MANY GREAT PRE-BUILT & TESTED CONSUMER PRODUCTS!

Noise Cancelling Headphones

AA-2054 \$25.00 + post and packing
Designed for use in noisy environments such as an aircraft or cars. They reduce background noise by as much as 15dB, so you can sleep soundly, concentrate better, or listen to your music without trying to "drown out" the noise. Two AAA batteries are supplied for power. 6' lead with a 1/8" plug.



3 Stage FM Transmitter Kit

KJ-8750 \$11.50 + post and packing

The circuit board may measure just 2"(L) x 1 1/16(W)", but it can transmit signals over half a mile in the open. It has flexible power requirements, with 6 to 12VDC input voltage (so a 9V battery would be suitable). It is quick to build, and fun to use. Kit supplied with circuit board, electronic components, and clear English instructions.



Remote Control Extender Kit MkII

KC-5209 \$13.25 + post and packing

If you have a source device such as a DVD player running to a TV in another room, or perhaps a Hi-Fi system with speakers in the other end of your house, you probably get tired of walking to the other room just to change tracks or fast forward etc. This project effectively transfers the IR signal from your remote control and re-transmits it in the other room! Kit includes case, circuit board, all electronic components, and clear English instructions.



Theremin Synthesiser Kit

KC-5295 \$34.95 + post & packing

The Theremin is a weird musical instrument that was invented early last century but is still used today. The Beach Boys' classic hit "Good Vibrations" featured a Theremin. By moving your hand between the antenna and metal plate, you create weird sound effects like in those scary movies! Kit includes a machined, silk-screened, and pre-drilled case, circuit board, all electronic components, and clear English instructions.



9VDC wall adaptor required (Jameco # 252751 \$10.95).



50MHz Frequency Meter Kit with LCD Display

KC-5369 \$49.95 + post & packing

If you want a great value frequency meter, then this project is for you. It features autoranging operation for ease of use, switching between its three ranges. High resolution of 0.1Hz up to 150Hz, 1Hz between 150Hz and 16MHz, and 10Hz above 16MHz. It can be powered by a 9V battery or wall adaptor (not included) and the case measures just 5 1/8" x 2 5/8" x 1". Kit includes laser cut & silk screened case, circuit board, electronic components, & clear English instructions.



We Stock...

Electronic Components

Electronic Project Kits

Test & Measurement Equipment

Power Products and Accessories

Audio & Video Equipment & Accessories

Computer & Telecoms Accessories

Security & Surveillance Equipment

Explanation of icons used for kits

Indicates an approximate construction time for each project for a competent constructor. It does not however, include any installation etc that may be required.



Straightforward to assemble, generally built in one session. Requires basic electronics and soldering skills.



Requires a good knowledge of electronics to understand its operation, and troubleshooting techniques may be required.



Log on to

www.jaycarelectronics.com/catalog

for your **FREE** catalog!

1-800-784-0263

(Monday - Friday 09.00 to 17.30 GMT + 10 hours only). For those that want to write:
100 Silverwater Rd Silverwater NSW 2128 Sydney AUSTRALIA

Jaycar

Electronics

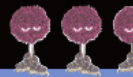

Measure the Speed of Light

Clocking the Cosmos for Less Than \$20.00

This Month's Projects

Speed of Light 38
Pulse Generator . . . 46
Relay Board 50



The Fuzzleball Rating System

To find out the level of difficulty for each of these projects, turn to Fuzzleball for the answers.

The scale is from 1-4, with four Fuzzleballs being the more difficult or advanced projects. Just look for the Fuzzleballs in the opening header.

You'll also find information included in each article on any special tools or skills you'll need to complete the project.

Let the soldering begin!

The speed of light is the fastest thing there is. Most people know that light travels at around 186,000 miles per second in a vacuum, but that speed is really incomprehensible. Compare it to a rocket that only needs to reach seven miles per second to escape from the Earth's gravity. To use a more common unit of measure, light travels at 670 million miles per hour; light travels just about one foot in one nanosecond (a billionth of a second). That's pretty quick. This project will allow you to measure the speed of light simply and inexpensively, as the basic parts cost well under \$20.00. However, you will need a good oscilloscope.

The Basics

There are a number of ways to measure the speed of light, and our approach here was chosen for a number of reasons. The first requirement was to use visible light. This makes optical alignment much easier. Besides, it only seems proper to be able to see what you are measuring. A second consideration was the need to keep it simple and small.

The "optical bench" is only 12 inches square. The transmitter uses only a single integrated circuit (IC) and the receiver uses only two ICs. The third requirement was to keep it inexpensive. If you buy all new parts, the cost should be under \$20.00. Most of my parts came from my junk box, so the cost was much less. A good oscilloscope will be needed; the bandwidth should be greater than 100 MHz for good results (mine was 300 MHz). The design goal is one nanosecond (ns) of resolution (not accuracy). Lastly, this approach will introduce you to a number of optical principles and characteristics.

Fundamentally, the idea is very simple. A clock creates regular pulses. A pulse is used to create a laser light pulse that is sent away from the apparatus and then reflected back. This causes the returned pulse to be delayed very slightly. If we "subtract" the original pulse from the delayed pulse, we will get a short pulse that is due only to the delay. This delay corresponds to the distance the light pulse traveled. Of course, things aren't quite that easy in practice.

Let's look at Figure 1. The clock is just a crystal oscillator, and the frequency is not really important. The choice of 4 MHz is fairly arbitrary. It is useful to have crystal stability because jitter on the oscilloscope trace will make it hard to read. This clock drives a semiconductor laser (which is just a cheap laser pointer). We use the laser because it creates a beam of light that's intense and narrow. The laser pulse travels out and bounces off a corner-reflector.

The corner-reflector is just a red bicycle reflector, but it has the very useful property of reflecting light back from the direction it came from, regardless of the angle. Trying to use an ordinary mirror requires a significant alignment effort (although it could be done that way). Using the corner-reflector is extremely easy, as it will always reflect directly back toward the source. However, this

Photo 1. This is the transmitter and some parts that require "field modification."

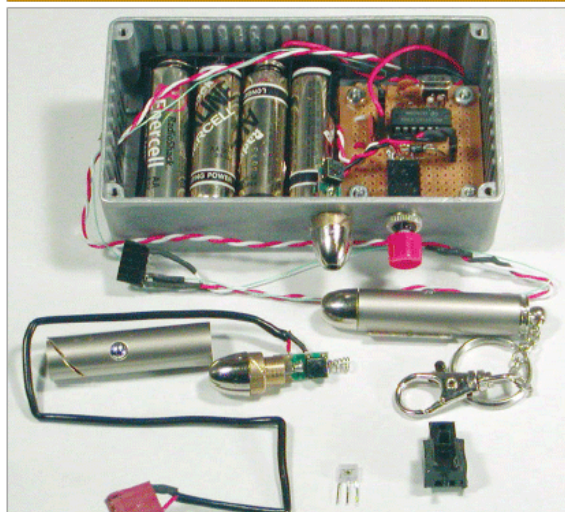

reflection is slightly scattered and is not a tight beam. For that reason, a lens is needed to focus the laser light onto the receiver. This lens is an inexpensive plastic Fresnel lens.

The beam splitter (just a piece of clear plastic) reflects only the returning light from the lens toward the receiver. Otherwise, the receiver would have to be in the same position as the laser. (We'll discuss the beam splitter and lens in more detail later.) The receiver creates an electrical pulse that is a duplicate of the transmitted pulse, but slightly delayed. These two signals are combined with an exclusive-OR (XOR) gate that "subtracts" one pulse from the other, leaving only those parts that are different. These differences are the results of the distance/delay and are displayed on the oscilloscope.

The Transmitter

Figure 2 shows the schematic diagram of the laser pulse generator or transmitter. As you can see, it's very simple. The first section of a complementary metal-oxide semiconductor (CMOS) inverter is used as a crystal oscillator. A second section is used to buffer the oscillator, and the last four sections are used in parallel for increased power to drive the laser diode. The rectifier diode, D2, does double duty. It prevents problems if the power is reversed, and it drops the six volts to about 5.3 volts so the inverter won't get upset. Resistor R3 and LED D1 are optional and are used as a power-on indicator. (It's just a habit of mine to include them.)

There are a few notes. The inverter can be almost any CMOS family (74H04, 74HC04, 74HCT04, etc.), but bipolar inverters won't work (7404, 74LS04, 74S04). You can certainly use a commercial oscillator instead of the crystal oscillator circuit. (In that case, you can eliminate R1, R2, C2, C3, and Y1. Connect your oscillator output to U1 Pin 3, and ground U1 Pin 1.) While the oscillator circuit is very robust and will work with nearly any crystal, keep the value around 4 MHz to match the receiver delay circuit (to be discussed later). A 3.57-MHz color-burst crystal should be fine.

Photo 1 shows the transmitter and some parts that require "field modification." I put the transmitter in a box because I have a feeling that I will find a number of uses for a laser transmitter that can be modulated at up to 20 MHz. As you can see, the actual electronics fits on a small, perforated circuit board, and point-to-point wiring was used.

The laser I used was a key-chain type that used three 1.5-volt button batteries (right center of Photo 1). I chose to remove the laser head from the body for ease of use. (You don't have to, but you will have to make power connections somehow.) I carefully used a hacksaw to remove the head assembly. You can see the spiral cut in the body (left center). The laser head consists of a lens, laser, and a tiny PC board (center). I attached power wires that

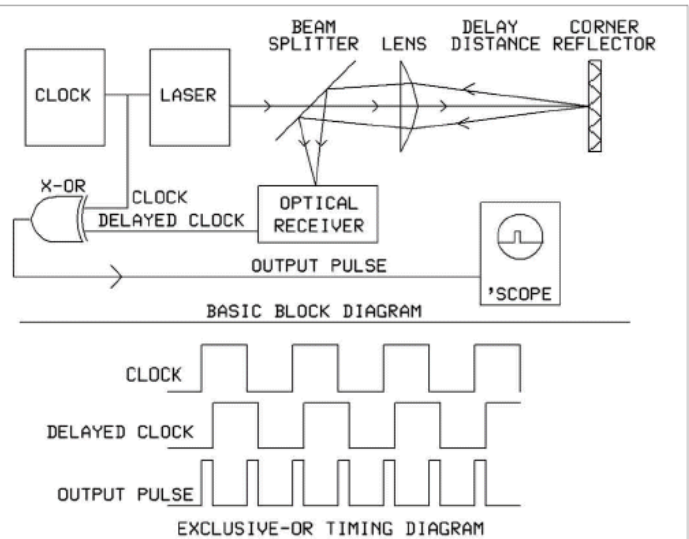

Figure 1. It is useful to have crystal stability because jitter on the oscilloscope trace will make it hard to read. This clock drives a semiconductor laser (which is just a cheap laser pointer).

bypassed the switch so I wouldn't have to press the button for the laser to work. The long leads were only for testing. (The two parts in the lower right of Photo 1 are the optical receiver and will be discussed later.)

Complete Ethernet Development Kit

KIT PRICE
\$99
Reg. \$199



SSL Ready

Breathe new life into your embedded systems with the Ethernet Connection Development Kit.

- RCM3720 RabbitCore™ with 512K Flash, 256K SRAM, 1MB Serial Flash, 33 digital I/O.
- Complete development software (not a trial version).
- Royalty-free TCP/IP stack and sample programs/libraries.
- Development board with prototyping area.
- AC adapter and complete documentation.

\$49

Free Book



Limited Time Only

Free Book With Kit
"Embedded Systems Design using the Rabbit 3000® Microprocessor"
www.rabbitetherkit.com



530.757.8400

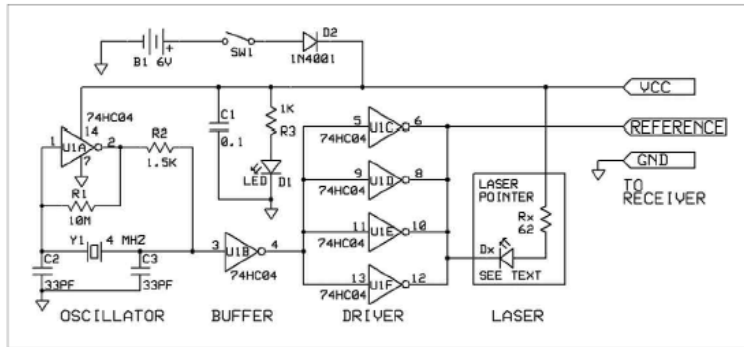

Figure 2. This is the schematic diagram of the laser pulse generator or transmitter.

The laser key chain I had on hand was very convenient. It worked on 4.5 volts, so a 5.3-volt, 50 percent duty-cycle signal didn't overload it.

There was no actual driver circuit for the laser. There was only a 62-ohm surface-mount resistor that limited current. This meant that I could drive it with a very fast signal without problems. A good laser pointer with a real current control circuit probably won't be able to handle the high-speed signals. If you use a laser that runs on three volts (or other voltage), be sure to use a suitable current-limiting resistor. My oscillator circuit used an additional 14 mA with the laser on. This means that the peak current was 28 mA (50 percent duty cycle). Since most of the red laser diodes are very similar, a 62- to 75-ohm current-limiting resistor supplying about 25 mA DC should be okay for a pulsed 5.3-volt operation. Also, the head assembly acts as a heatsink. It is critical that the heatsink be functional; otherwise, the laser will quickly overheat and destroy itself.

The Optical Bench

When you work with optics, it's important to be able to keep components stable and fixed. It's also important to be able to remove a component and then replace it easily. The tool used for this is called an optical bench. A professional optical bench is typically made of metal, about two by three feet, and has holes every inch (sort of like large perf-board). Optical component carriers hold

the optical elements, while the base of the carrier plugs into one or more holes in the bench. Optical benches can cost \$1,000.00 or more. That's a little pricey for us, so we will create a single-use optical bench out of wood.

There are many approaches to building the bench. I'll explain how and why I built mine the way I did. (Feel free to choose the methods that you feel most comfortable with.) Photo 2 shows the basic layout. The base is a 12 x 12-inch piece of particle board. The transmitter case is snugly held in place with pieces of 3/4 x 1-inch wood screwed to the base. The beam splitter rests in a slot I cut out of a scrap of 2 x 3/4-inch wood. The wood is also screwed to the base.

I used shims cut from a business card to keep the plastic snug in the slot.

A similar procedure is used for the Fresnel lens. The optical receiver PC board is raised to the approximate height with a wooden base. For fine tuning of the height, I used long screws as feet. By adjusting the screws, I could position the receiver with precision. The receiver was held in place with high-tech, one-dimensional organic tension straps (otherwise known as rubberbands). The corner-reflector shown in Photo 2 is just taped to an empty reel of wire to keep it vertical. In actual use, it is not part of the bench assembly and is placed several feet away.

There are a few things to discuss about the beam splitter and the Fresnel lens. The beam splitter is just a scrap piece of clear plastic. It's about 4 x 4 x 1/8-inch thick. Any piece of clear plastic should be okay. Its distance from the laser and the mounting angle are not too important. Give yourself room for the other components. (I guessed, not measured, around 45 degrees.) You can use glass for your beam splitter, but, obviously, glass is sharp and fragile. Additionally, it's hard to drill a hole in glass. There is a hole in the center of the beam splitter, but it's very hard to see in the photo. It's not absolutely necessary to have the hole, but it helps. Here's why: If we split the beam on its outward leg, we lose about 50 percent of the light. Obviously, we want as much light reflected as possible, hence the hole. There is also a hole in the Fresnel lens, but this hole is critical. If the outgoing laser beam passes through the lens, the beam will spread out too much.

The Fresnel lens I used was a credit card magnifier (or "wallet" magnifier) that was a free promotional item I got from some company years ago. Its placement isn't too critical. Just remember that the focal length is about 3.5 inches (yours might be different). Therefore, the distance from the lens to the beam splitter to the optical receiver IC will be that length.

Figure 3. This is the circuit of the Sharp GPIFA551RZ fiber-optic receiver. For under \$2.50 it is fast, with a response of 13.2 MHz.

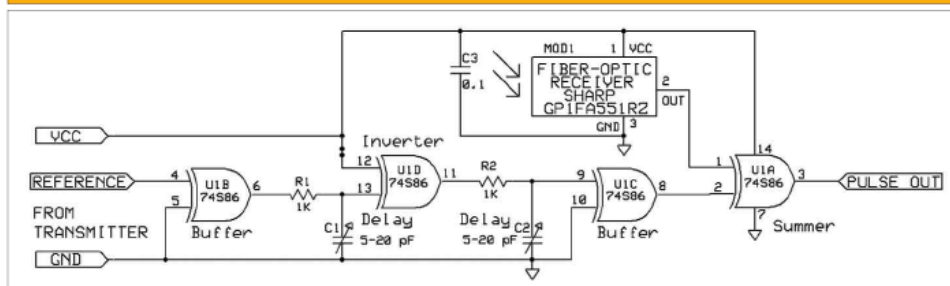

The important thing is to make sure that the parts don't interfere with each other.

The easiest way to find the precise location for the holes in the beam splitter and lens is to fix the components on the bench and turn on the transmitter. It is easy to see where the light passes through the plastic and lens. Mark that spot and drill an 1/8-inch hole. You may have to enlarge it slightly to allow the whole beam to pass through, but don't make it any larger than necessary. You lose this area when the reflected beam comes back. Since the beam splitter is mounted at a 45-degree angle to the laser beam, the hole should also be at 45 degrees. Otherwise, the beam will hit the edges of the hole. This should be done after the initial hole has been drilled. If you used a hand drill, secure the plastic in a vise with the drill through the hole. Then carefully start the drill and slowly move the drill to the proper angle. The edge of the bit will cut/melt the plastic. If you used a drill press, start it up before you manually twist the plastic. Use gloves or a drill press vise to hold the plastic for safety.

The Receiver

After a couple of attempts to build a simple, low-cost, high-speed optical receiver that resulted in marginal success, I decided to use the Sharp GP1FA551RZ fiber-optic receiver. It's very cheap — under \$2.50. It's simple to use — three pins. Also, it's fast, with a response of 13.2 MHz. Figure 3 shows the circuit, but the actual receiver circuit is trivial. Connect the Sharp IC to power and ground and run the output to the XOR. Bypass capacitor C3 is required (placed at the receiver IC), as the circuit will oscillate without it.

What's with the other three gates, though? What are they there for? They're not in the block diagram. These gates are needed to invert and delay the reference signal

Photo 3. This is a typical output pulse with a 300-MHz 'scope.

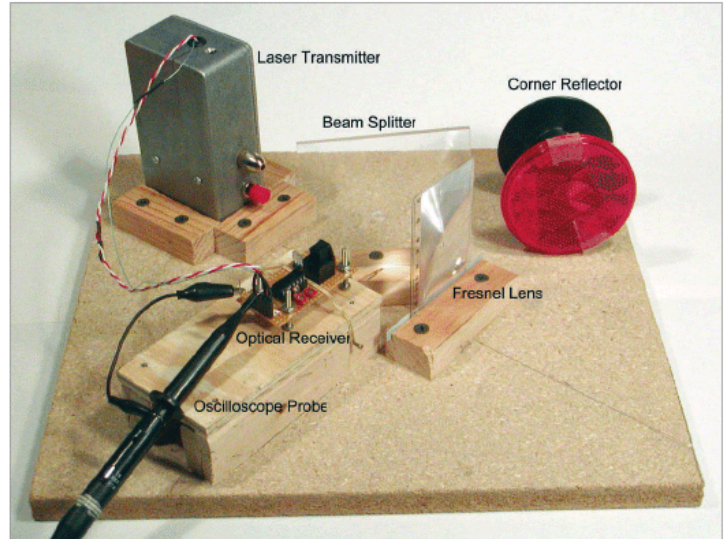
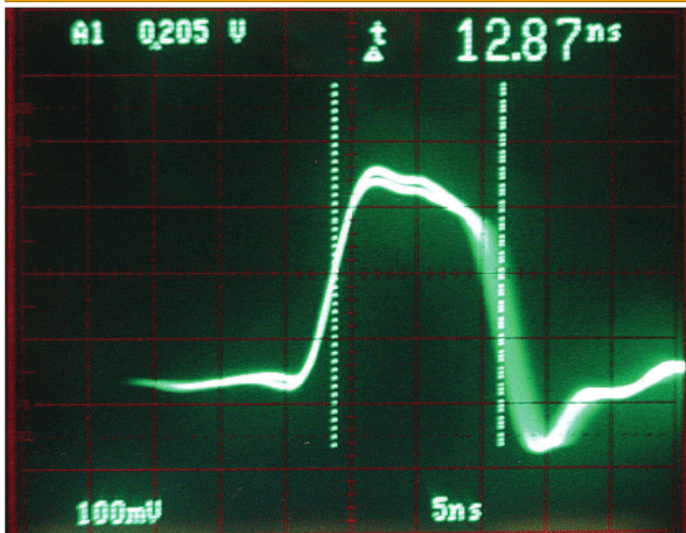
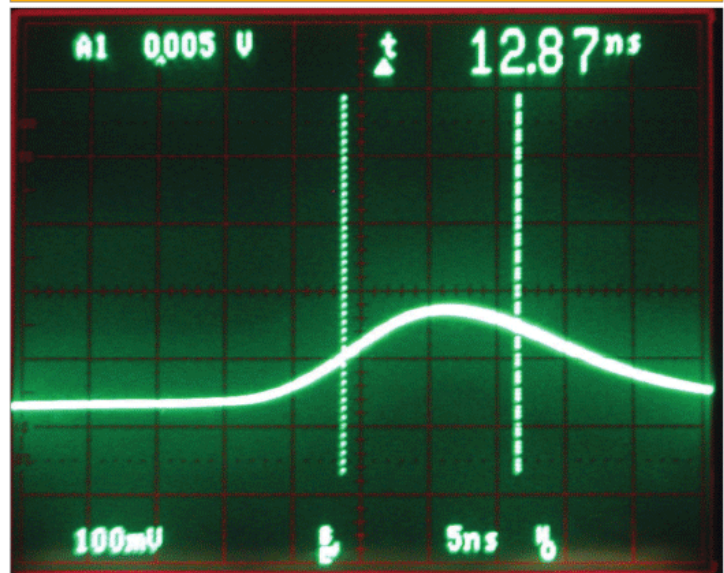

Photo 2. The basic layout. The base is a 12 x 12-inch piece of particle board.

to compensate for the delays in the laser and receiver. We want to measure only the time it takes light to exit the laser and return. Unfortunately, all electronic components require some time to operate. There are a few nanoseconds (ns) of delay from when power is applied to the laser and when light is emitted. There is also a delay from when light strikes the photo diode in the receiver to when a signal is available at the output pin. Surprisingly, the receiver has a worst case delay of 180 ns. This is very large. The good news is that the jitter — or delay variability — is typically only one ns. Since 13.2 MHz corresponds to a wavelength of about 57 ns, I figured that a realistic “typical delay” estimate should be no longer than that (for a strong signal). Therefore, I chose to design the delay circuit for about 60 ns. (Note, you can choose not to use

Photo 4. This shows that same pulse as in Photo 3, but with the bandwidth limited to 20 MHz.



delay compensation. In that case, all your measurements will be off by a fixed amount. You can subtract this amount manually to find the speed of light, but it's not very elegant.)

Let's step through the circuit. First, you must use a Schottky 74S86 (not the 7486 or the 74LS86). The 74S86 has a symmetrical, 10-ns, low-to-high and high-to-low delay. Of course, the other families have different propagation delays. Remember, we want to resolve one ns. The first thing we do is buffer the reference signal. The XOR with one input connected to ground does this. Then

we delay the signal with R1 and C1. This provides about five to 20 ns of delay. Then, the signal is inverted by connecting an input to a logic high. Next, we delay this by five to 20 ns with R2 and C2. Finally, the signal is buffered again with the last section of the XOR chip. The delay is 30 ns for the three XOR sections and 10 to 40 ns for the delay circuits for a total delay of 40 to 70 ns.

There are some subtle points to note. Two resistor-capacitor (RC) delay circuits are used because the XOR output has asymmetrical drive. It sinks much more current than it can source. This means that the capacitors will discharge faster than they charge. If only a single RC delay was used, the rising edge would be delayed more than the falling edge. By using two RC delays — one on an inverted signal and the other on a non-inverted signal — we can control the delay of each edge and can make the delays symmetrical. (Note, if your receiver has a significantly different delay, you may have to adjust the values of the RC circuits. For more delay, increase the resistor and/or the capacitor values, and for less delay, reduce them.)

The other point is a very useful property of the XOR gate. A logic low at one input means the output follows the other input. A logic high at one input will invert the signal at the other input. This means that you can control the inversion (or phase) of a signal with a logical value without changing the propagation delay. If you do a lot of digital design, you will find this little trick valuable.

Unfortunately, there is a problem with the receiver. The actual IC is a small three-pin device buried in a large plastic housing, which is normally mated with a fiber optic cable. It's very difficult to align the laser light to shine deep into the small hole used for the cable. While that is possible, it's much easier to remove the IC from the housing. I know because I tried it both ways. Look closely at Photo 2. At the front is a large, black component. That's the optical receiver. If you look to its immediate left, you will see a small, clear, plastic object. That's the actual receiver IC that has been removed from the housing. A better picture of the receiver and housing is shown at the bottom right in Photo 1.

I was successful in removing the receiver IC with two different methods. The first, shown in Photo 1, was to very carefully saw the sides of the housing until I reached the cavity that held the actual IC. However, once I did that and was able to examine the inside of the housing, I noticed that two small retention barbs held the IC in place. These barbs are accessible where the IC leads exit the cavity. The next time, I used an X-acto razor knife to cut these barbs away. With a little inward pressure on the face of the IC through the hole (using a toothpick) and gentle pull on the leads, the IC was removed.

Setup and Operation

Physically adjust the transmitter, beam splitter, and

Parts List

Transmitter

R1	10M	1/4 W
R2	1.5K	1/4 W
R3	1K	1/4 W
Rx	Part of laser pointer, see text	
C1	0.1 μ F	25 V
C2, C3	33 pF	25 V
D1	Red LED	
D2	1N4001	
Dx	Key chain laser pointer (see below)	
Y1	4 MHz crystal	
SW1	SPST switch	
U1	74HC04 hex inverter	

Note: There are many sources for these inexpensive lasers. I'm quite sure I got mine from All Electronics a few years ago. They currently have them listed as LP-506 on their website (www.allelectronics.com) for \$4.75. Hosfelt Electronics has a similar item, 75-374, for \$5.95 at www.hosfelt.com. Officemax item 11134783 appears to be similar at \$10.99.

Receiver

R1, R2	1K	1/4 W
C1, C2	5-20 pF variable cap	
C3	0.1 μ F	25V
U1	74S86 Schottky Exclusive OR Do not substitute.	
MOD1	GP1FA551RZ Sharp fiber-optic receiver IC (13.2 MHz speed)	

Available from Digi-Key, 425-1109-5-ND @ \$2.38 each (www.digikey.com)

Optical Bench

Beam-splitter	4" x 4" x 1/8" clear plastic (see text)
Lens	Credit card/wallet Fresnel lens magnifier 2" x 4" (approximately)
Edmund Scientifics	www.scientificsonline.com part 3038456 @ \$1.95 each looks identical to the one I used. Officemax part 11035435 (\$9.99) might be useable, but it has a handle. A web search brings up many listings.
Misc.	12" x 12" wood base, small wood strips to mount parts, screws, etc.

lens position so that the beam of light passes through the holes. Then place the corner-reflector about five to 10 feet from the bench. While, in theory, the corner-reflector can be at any angle to the beam, it's best if the laser light hits it head on. This will reflect light back and through the lens and beam splitter. A white card or piece of paper will show where the beam is focusing into a point. This is precisely where the optical receiver IC must be located. (Note that you will probably see two closely-spaced points of light. This is because the light reflects from both the front and back surfaces of the beam splitter. With 1/8-inch-thick plastic, the two points will be about 1/8-inch apart. Thinner plastic brings the points closer together.)

Once the optical alignment is complete, connect the high-speed oscilloscope to Pin 3 of the 74S86 (summed output). (I used an oscilloscope with a 300 MHz bandwidth.) In Photo 2, you can see that I brought this out to a test point. Connect the probe as close to the chip as possible and do not use a cable or a long length of wire. Remember, we want to measure nanosecond signals. You should use a 10X probe for better signal response. With the corner-reflector removed, you should see the "clock" signal, as shown in Figure 1. With the corner-reflector in place, you should see the signal change to the "output pulse" form (also shown in Figure 1). You may want to fine tune the optical alignment with the oscilloscope. A good alignment is indicated by a stable signal with the narrowest pulse width (more on that later).

In order to adjust the delay circuits properly, we need to reflect the beam right back from the face of the lens. (Unfortunately, it's difficult to do this because the beam is very narrow at that point and reflects back through the holes in the lens and beam splitter without reflecting onto the receiver IC. I "cheated" a little by reflecting some of the beam just as it came out of the laser directly onto the IC. This distance "error" is about six inches (or about 0.5 ns) and I felt that it was insignificant.

With a direct signal into the receiver circuit, adjust the capacitors so that the output pulses narrow and disappear. At this point, the delay from the delay circuit exactly equals the delays from the laser and receiver. (You may have to fiddle with the delay-component values as previously mentioned. However, my receiver worked well without any component adjustments.) Now, we're ready to actually measure the speed of light.

Results

Photo 3 shows a typical output pulse with a 300-MHz 'scope. Photo 4

shows that same pulse with the bandwidth limited to 20 MHz. As you can see, you will need a 100-MHz bandwidth for reasonable results. The corner-reflector was placed 10, 15, and 20 feet from the optical bench. This means that the actual travel distance was twice that (out and back). Here's what I measured:

<u>Distance</u>	<u>Delay</u>	<u>Measured speed</u>	<u>Error</u>
20 feet	15.2 ns	249,000 miles/s	+34%
30 feet	27.2 ns	208,000 miles/s	+9%
40 feet	42.4 ns	183,000 miles/s	-1.7%

Okay, so the results aren't all that accurate, but — for \$20.00 worth of parts — it isn't that bad. I suspect that much of the problem lies with the receiver delay. I would be very surprised if the light intensity didn't have a significant effect on its delay (which is why I adjusted the optics for the shortest pulse). This is evidence that the intensity changes the delay. I didn't measure this. (However, you can do this by keeping the corner-reflector at a fixed distance and changing the laser intensity with an optical filter. This will provide "first order" compensation values that can be used to correct the readings.)

There are a number of variations to the design that are possible. As mentioned before, a mirror can be used instead of the corner-reflector. In that case, the beam splitter and lens may not be required (although a lens may still be helpful). You can measure the speed of light in water by submerging the corner-reflector in a swimming pool. You can always redesign the receiver using discrete components for better delay characteristics.

Use your imagination. **NV**

8-16-bit EEPROM | Serial EEPROM | FLASH EPROM | GAL / PALCE | Most MCU's | Low Voltages to 1.3V. | DIL dev. w/o Adapter.

Conitec's last generation Galep-4 employs ASIC universal pin tech-

microcontrollers such as 87/89xxx, PIC, AVR, ST62, etc. Low voltage devices down to 1.3V. No adapter required for DIL devices. 8 Hrs. operation on battery (AC charger included). Runs WIN 98, NT, ME, 2000, XP with Hex/Fuse Editor.

Remote control from other apps, (e.g. VisualBasic). Substitutes high priced universal programmers e.g. ALL-11 (HIL0) or LAB-TOOL-48 (ADVANTECH) Providing virtually matching performance at only 1/3-1/5 the price. Info, orders, softwr: 619-702-4420



nology for each pin of 40 pin ZIF-socket. 6100+ device library / lifetime free updates. Programs 8/16 bit EPROM'S, EEPROM'S, 0-Pwr RAM, FLASH, Serial EEPROM'S, GAL, PALCE,

6100
DEVICES
CONITEC

One Small Programmer handles 5,500 devices. Introducing the diminutive GALEP-4



SMALL PACKAGE. BIG FEATURES.
DEVICE PROGRAMMERS SINCE 1985

SALES, SUPPORT, INFO / (EMAIL) CONTACT@CONITEC.NET - (URL) WWW.CONITEC.NET TEL: 619-702-4420. FAX: 619-702-4419

Bus Embedded Internet PC RTOS CAN Bus Embedded Internet PC RTOS CA

CCS C Compiler
for the PICmicro® MCU
262-522-6500
www.ccsinfo.com/env



USB Add USB to your next project—
it's easier than you might think!

DLP Design

- USB-FIFO • USB-UART • USB/Microcontroller boards
- Absolutely NO driver software development required!*

www.dlpdesign.com Design services available

superbrightleds.com

LEDs LED Bulbs LED Products

USB/Serial Pic Programmer Kit \$34.95

- * Free software and updates Windows 9x/2000/Nt/XP
- * Quality PCB and Silkscreen for easy assembly

See all of our Educational Electronic Kits
visit us at www.ElectronicKits.com



www.CircuitSpecialists.com

OVER 8,000 ELECTRONIC ITEMS ONLINE!
Deals You Won't Believe!

ramsey
www.ramseykits.com

AM/FM Broadcasters • Hobby Kits
Learning Kits • Test Equipment
...AND LOTS OF NEAT STUFF!



electronicsurplus.com

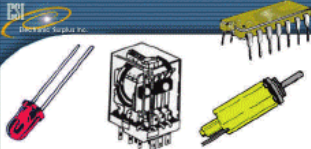

AREXX Engineering



Your BASIC Stamp Headquarters

PARALLAX

www.parallax.com



MCUmart.com

PICmicro MCU Development Tools

BASIC Compilers
Device Programmers
Prototyping Boards
Experimenter Boards
Books

JK Microsystems **µFlashPlus 84-0040 Kit**
Embedded Intel 386EX Board — *Only \$79 each!*



www.northwesttechnical.com

HSC Electronic Supply

www.halted.com

IMAGES SI INC.

Self Test Mode
Baud rate: N9600

One-Wire Serial LCD Module \$ 38.95
www.imagesco.com/catalog/pic/lcd.html



Save up to **60%** on
electronic components
and microcontrollers

www.futurlec.com

C&S SALES

The one-stop source for all
electronic needs!

www.cs-sales.com



MADDELL TECH
www.madelltech.com

Oscilloscope, Spectrum Analyzer
Function Generator
Rework Station, Reflow Oven
DC Power Supply

TARGET 3001!

ELECTRO-NET

Thousands of active electronics hobbyists, experimenters,
and engineers are just a mouse click away from your
website. Now you can get *both* a print ad and Internet link
for one low price.

We'll place your ad on the Electronics Links page of our
website with a hotlink directly to your
website — Plus run your ad in the Electro-
Net section of Nuts & Volts. All for one low
monthly price. Call for pricing today!

Try It! (951) 371-8497



Program in C!

Full hardware +
software
system \$125!

www.garage-technologies.com



Solutions³

Affordable Motion
Control Products

www.solutions-cubed.com

NUTS & VOLTS

Remember when...

...electronics stores were stocked to the rafters

with every component imaginable and there was ALWAYS

a knowledgeable person there to help you?

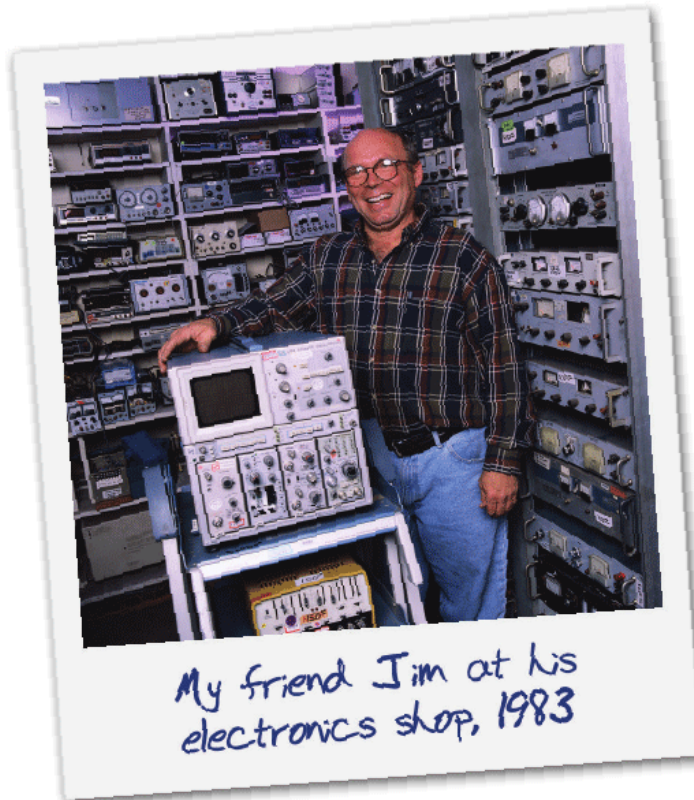

Think those days are gone?

Well they're not!

You just need Jameco!

Call for a FREE 256-page catalog today.

We have the electronic components and knowledgeable Technical Support people who can help **bring back the fun** in your electronics hobbies, inventions, and DIY projects.

JAMECO[®]
ELECTRONICS
Great Products. Awesome Prices.
1.800.831.4242

Be sure to visit our new website at
www.jameco.com/nvd

Jameco Electronics
—where electronics is still fun!

Circle #42 on the Reader Service Card.

Building a Pulse Generator

Design, Troubleshoot, and Calibrate Electronic Circuits

If you work with digital and logic circuits (and we all do), you will find this instrument handy for design, troubleshooting, and calibration of electronic circuits. Although I own a somewhat expensive commercial function generator, I find that this pulse generator is the one I reach for most of the time. The generator is fairly easy to build and uses a straightforward design. It requires six integrated circuits and two transistors. In addition, you will need a power supply of 15 volts at 200 mA.

You may build this unit as shown or add/delete stages if you prefer something more customized for your needs. In two years of use, I have not felt any need to change the design, as it has worked well under all situations.

I housed this unit in a 7 x 4 x 5-inch box. If you build it exactly as shown, do not use a box any smaller than this, as you will be crowding the front panel controls. Before we get into the construction, I feel that a description of the theory of operation is in order.

Referring to the schematic (Figure 1), the heart of the unit is the U4 rate generator and the U3B width generator. The U4 multivibrator rate is set in six steps by capacitor selection of S6a, S6b.

This, in turn, is varied by potentiometer P2 to give complete coverage between bands. The RATE change is two microseconds to one second continuous with R9 and P2 values giving an approximate 10 percent overlap between ranges. The squarewave output is sent through U5a,b (AND gate), which provides buffering to U4. One gate sends the signal to J3 (internal trigger out). The other gate sends the signal to U2b-P5, which isolates the various inputs from each other by an OR gate function.

The positive edge from the output of U2b triggers the width generator, U3b. Incidentally, all of these circuits are positive-edge triggered. U3b is a monostable multivibrator, and its output width is determined by capacitor selection via S7a, S7b. As in U4, it is varied by

Figure 1. The heart of the unit is the U4 rate generator and the U3B width generator.

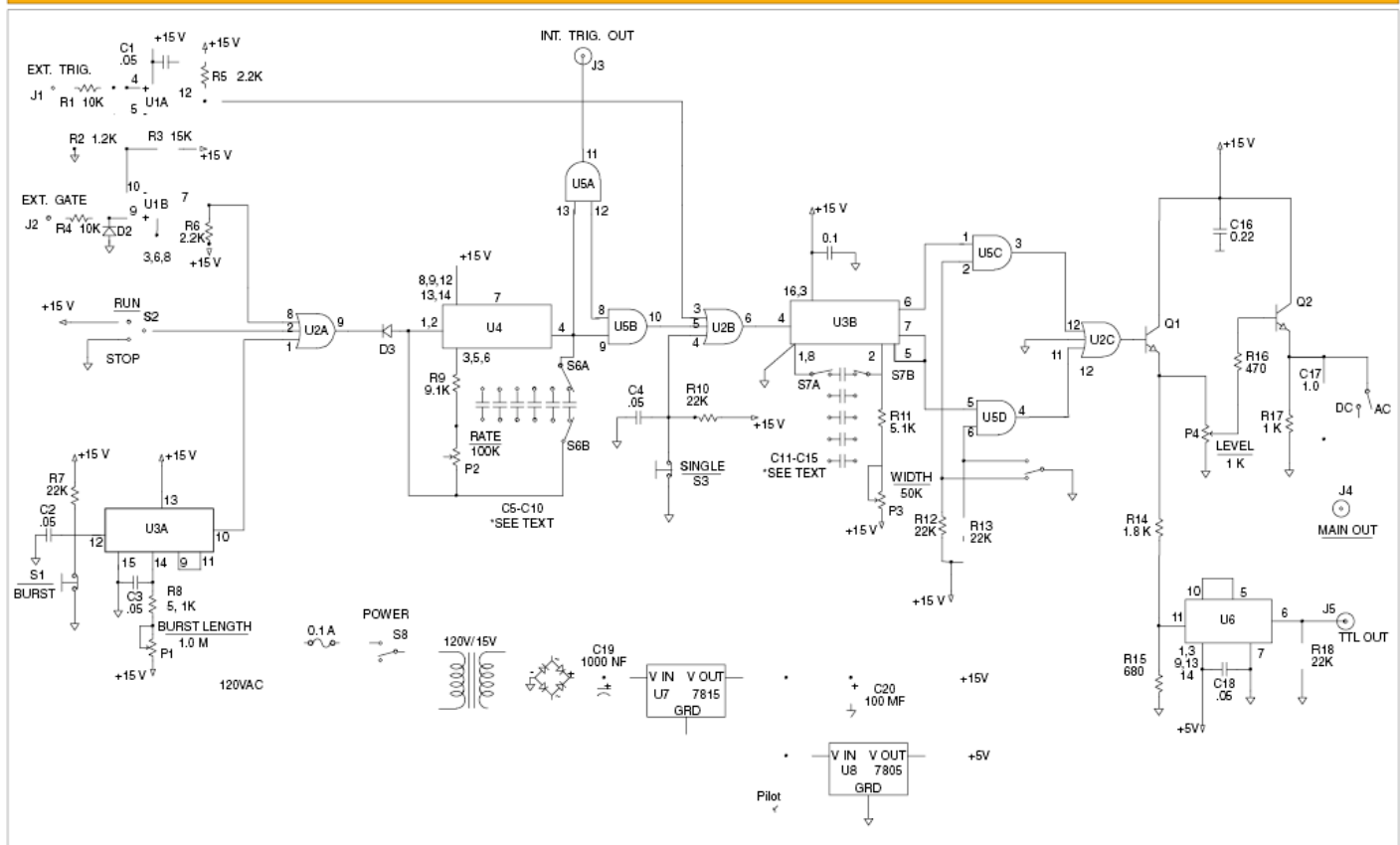

potentiometer P3 (also providing a 10 percent overlap) to provide continuous converge from one microsecond to 100 milliseconds in width. The output of U3b is sent through U2c to the base of Q1. In conjunction with S4, U5c and d provide the option of positive- or negative-going pulses (Q or Q not).

The pulse level at this point is 15 volts peak, and the job of emitter follower Q1 is to drive the pulse-level control P4 and the translator circuit R14, R15 to operate TTL level U6 for the rapid rise and fall times required by this family of circuits.

From the output of the pulse-level control, the pulse is sent to Q2 via R16. Q2 is a current amplifier to drive very low impedance loads. Its output impedance is on the order of 10 ohms and will easily drive 50-ohm loads at five-volt logic levels.

The main output at J4 is AC or DC coupled, as selected by S5. The output at this point is zero to 14 volts, peak. R17 is a pull-down resistor to help speed up fall times. R16 was arbitrarily chosen to reduce overshoot and ringing.

Switch S2 (run-stop) provides several options. In the run position, the U4 rate generator runs continuously and provides the trigger for U3b. In the stop position, U3b triggering can be any of the following:

- Externally triggered through J1
- Single shot triggered via S3 (single) – one pulse per depression
- Externally gated through J2
- Internally burst triggered via S1 (burst) – one burst per depression

U1 and U2 are identical high-speed comparators and will accept any wave shape from DC to 1 MHz. Their input voltage range is from 1.3 to 15 volts, peak. The input impedances are one megohm. U3a is the burst length generator and will send out one group of pulses every time S1 is depressed. The actual amount of pulses is determined by the front panel control settings and the burst-length time chosen by potentiometer P1. In my unit, I chose a range of 0.1 to 20 milliseconds for this circuit. You can vary yours by changing the RC time constant of P1, C3.

C1 and C2 provide a cheap means of debounce for the contacts of S1 and S3, respectively. The main output (J4) has a pulse rise time of 10 nanoseconds and is compatible to complementary metal-oxide semiconductor (CMOS) or bipolar circuitry. The TTL output (J5) is compatible for this type of circuitry, as mentioned previously. The features built into this generator have sufficed for all my needs.

Now, on to construction. As I mentioned earlier, the box I used would be as small as you want to go. I even had to mount most of the power supply components on a back inside corner of it and mount the power-on switch

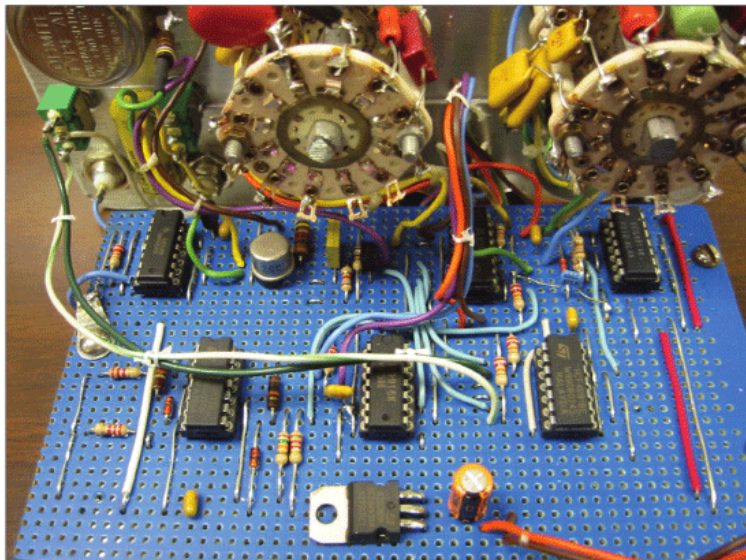

Figure 2. The board is 3.25 x 5.5 inches.

on the back of it. I am not going to dwell on power supply construction, as you can use any configuration you like, even to the extent of incorporating a wall transformer, if necessary. Just make sure that it will fulfill the circuit requirements of 18 to 22 volts and a minimum of

Seetron Serial LCDs

Interface a sharp LCD display to your BASIC Stamp® or other micro-controller project with ease. No-solder wiring harnesses and easy mounting kits available too. See www.seetron.com today.

- 3.2 x 1.4 in. supertwist LCD
- 2400/9600 baud serial
- Low (~2mA) current draw
- Great with BASIC Stamps®

\$45
BPI-216N



- 3.2 x 2 in. backlit LCD
- 1200-9600 baud serial
- Advanced protocol, 4 switch inputs
- EEPROM for configuration settings
- Favorite for OEM applications

\$49
ILM-216L

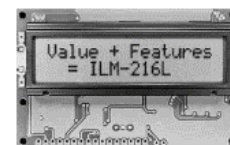

- 3.2 x 1.4 in. graphics LCD
- 2400/9600 baud serial
- Font and 15 screens in EEPROM
- Easily draw points, lines, screens

\$99
SGX-120L



- 3 x 2 in. supertwist LCD
- 1200-9600 baud serial
- ESD-protected, 4x4 keypad input
- Store up to 95 screens in EEPROM

\$119
TRM-425L



Scott Edwards Electronics, Inc.

1939 S. Frontage Rd. #F, Sierra Vista, AZ 85635
phone 520-459-4802 • fax 520-459-0623
www.seetron.com • sales@seetron.com

More displays available,
including bright VFDs.
See www.seetron.com



Figure 3. The rates and widths are marked on the front panel.

200 mA.

I built the actual circuit on a perf board with traces that would accept dual inline package (DIP) sockets. I always use sockets in my projects for future modifications or troubleshooting. This board was 3.25 x 5.5 inches and was laid out as shown in Figure 2. Almost all

of the components were installed on the board with the exception of C5 through C15, which I will address shortly.

Q2 was chosen for its high-speed operation and power handling ability. Most high-speed switching transistors will work fine, and even the lowly 2N3904 performed satisfactorily in this circuit. C16 should be mounted close to this collector. No circuit layout problems were encountered in this construction, even with the front panel wires grouped and laced. J1, J2, and J3 are all accessible through a cutout in the back wall of the housing.

As for the timing capacitors, C5 through C15, I elected to mount these between the decks of rotary switches S6 and S7. When the associated variable controls (P2 and P3) are in their calibrated position (fully counterclockwise), the rates and widths will be as marked on the front panel switch positions. These are as follows:

RATE:

2 μ sec, 10 μ sec, 100 μ sec, 1 msec, 10 msec, 100 msec

WIDTH:

1 μ sec, 10 μ sec, 100 μ sec, 1 msec, 10 msec

The variable controls will take you from one range up to the next, with a 10 percent overlap to ensure complete coverage. In the calibrate position, accuracy will depend on how close the capacitor values are to the required values.

On some ranges, I nailed it on the first capacitor picked. On others, I had to sneak up on it with two capacitors (one large, one small). I aimed for one-percent accuracy on all ranges, and it was not difficult to obtain this. There is no point in trying for greater accuracy than this, as capacitor stability will not guarantee the timing will remain that stable. If you want greater stability and accuracy, you will have to use expensive polystyrene or similar capacitors.

These extreme accuracies are really not necessary, as you will usually be using this unit in conjunction with other test equipment (scopes, etc.) for cross-checking. The parts list shows the target values of capacitors C5 through C15. These values may vary in your particular circuit, but offer a close starting point.

Also, the potentiometers (P2 and P3) can be shunted with high-value resistors to slightly alter their values and bring the low-end timing (P2 and P3, fully clockwise) more in line with the expected rates and widths at these points. The important function in these two circuits is not so much that you have front panel accuracy, but rather that you have complete coverage across the switched bands.

The actual output drive current that the generator will produce depends on transistor Q2 and the duty cycle (per-

Microprocessor Hands-On Training

The PRIMER Trainer is now **New & Improved** and even easier to use. The PRIMER is a flexible instructional tool featured in Prentice Hall textbooks and used by colleges and universities around the world. Ruggedly designed to resist wear, the PRIMER supports several different programming languages. A comprehensive Self Instruction Manual and an Applications Manual provides lessons, theory, and sample code for a number of Hands-On lab projects.

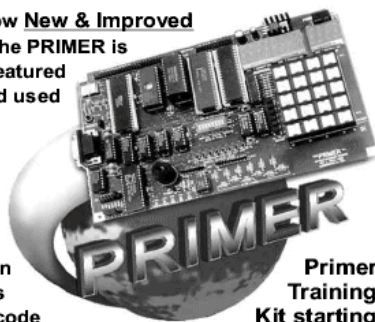

Primer Training Kit starting at \$120.00 USD

- Scan Keypad Input & Write to a Display
- Detect Light Levels with a Photocell
- Control Motor Speed using Back EMF
- Design a Waveform Generator
- Measure Temperature
- Program EPROMs
- Bus Interface an 8255 PPI
- Construct a Capacitance Meter
- Interface and Control Stepper Motors
- Design a DTMF Autodialer / Controller
- Programming a Reaction Time Tester

Application Projects Include:

Since 1985
OVER
20
YEARS OF
SINGLE BOARD
SOLUTIONS

EMAC, inc.

Phone 618-529-4525 Fax 618-457-0110
2390 EMAC Way, Carbondale, IL 62901
World Wide Web: www.emacinc.com

centage of time that Q2 remains at a high-level voltage). For the transistor shown, it will deliver 500 mA at a 10 percent duty cycle with no degradation in pulse specs. For an example, a 2N3904 would deliver 100 mA under the same conditions.

For U6 (CMOS to TTL translator), I used a hex inverter only because it was handy. Any TTL gate configuration is suitable; just make sure the output remains non-inverted with respect to the input.

Upon completion, if you encounter problems, start by checking the power supply sources (+15 and +5 volts). Then look at rate generator U4 to make sure it is running. U4 will run when U2a-P9 is positive and stop when it's negative. Beyond the generator and due to circuit simplicity, you can go stage by stage using standard troubleshooting techniques.

When you finish this project, you will have a source of pulse generation capable of a wide range of outputs:

Rate – continuously variable from two microseconds to one second

Width – continuously variable from one microsecond to one millisecond

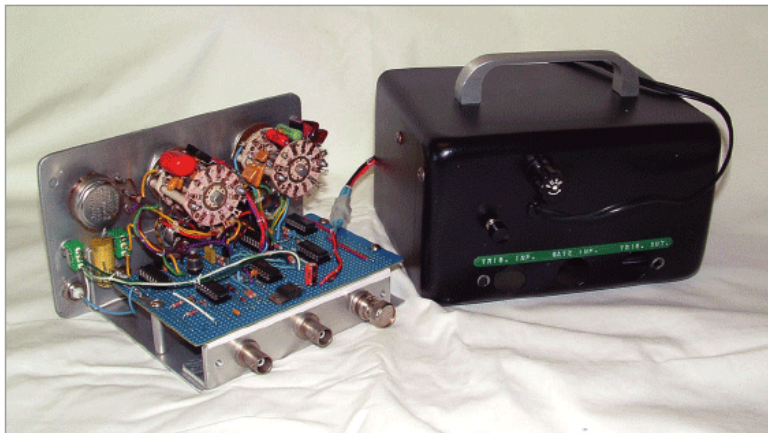

Figure 4. The power switch is located on the back of the case.

Trigger – continuous, single burst, internal or external

Output – adequate drive for virtually any circuitry (zero to 14 volts, peak)

Personally, this was an interesting and fun project to build and has proved to be an essential piece of gear to my test bench. Take your time building this, do a professional job, and you will be as satisfied as I am. **NV**

PicoScope 3000 Series PC Oscilloscopes

The PicoScope 3000 series oscilloscopes are the latest offerings from the market leader in PC oscilloscopes combining high bandwidths with large buffer memories. Using the latest advances in electronics, the oscilloscopes connect to the USB port of any modern PC, making full use of the PCs' processing capabilities, large screens and familiar graphical user interfaces.

- High performance: 10GS/s sampling rate & 200MHz bandwidth
- 1MB buffer memory
- High speed USB 2.0 interface
- Advanced display & trigger modes
- Compact & portable
- Supplied with PicoScope & PicoLog software

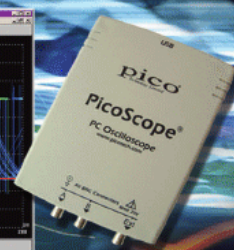
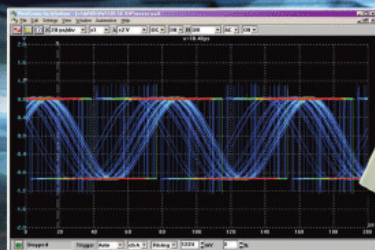

PicoScope	3204	3205	3206
Bandwidth	50MHz	100MHz	200MHz
Sampling rate (repetitive)	2.5GS/s	5GS/s	10GS/s
Sampling rate (single shot)	50MS/s	100MS/s	200MS/s
Channels	2+Ext trigger	2+Ext trigger/Sig gen	2+Ext trigger/Sig gen
Oscilloscope timebases	5ns/div to 50ns/div	2ns/div to 50ns/div	1ns/div to 50ns/div
Timebase accuracy	50ppm	50ppm	50ppm
Spectrum ranges	0 to 25MHz	0 to 50MHz	0 to 100MHz
Buffer memory size	256KB	512KB	1MB
Resolution / accuracy	8 bits / 3%		
Ranges	±100mV to ±20V		
PC Connection	USB2.0 (USB1.1 compatible)		

Tel: 585 385 1750

www.picotech.com/scope259

pico[®]
Technology Limited

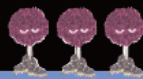

Universal Relay Board

The Applications are Limitless

This universal relay board will allow you to drive a 12-volt DPDT relay using heat, cold, light, dark, sound, logic-level voltages, and just about any varying resistive output sensor you can think of. In fact, you can use it to switch the relay ON or OFF using any voltage between zero to 12 volts DC or any sensor that has a varying output in this range. This is the ultimate relay board. It could even be made to run on six- or 24-volts DC with a few resistor changes and the availability of the appropriate voltage relay.

I set out to design this project with simplicity in mind; I wanted to keep the component count to a minimum and to use the same value components for all configurations available. Size was also a factor — the smaller, the better. There are heaps of similar individual circuits around in kit form, in books, or on the Internet, but none that integrates everything and allows the user the flexibility that this circuit does with a minimum of fuss.

First things first: Decide how you will configure the relay (e.g., heat, cold, sound or five-volt logic, light or dark). Then decide if you want to trigger the relay ON or OFF (e.g., hotter — on, hotter — off). See the configuration details in Table 2 to help you make your choice.

Basically, we need a resistive-type sensor with an opposing fixed resistor to form a varying-input voltage divider or a sensor, etc., that has a varying voltage output.

Some Available Sensors

Thermistor NTC

The negative temperature coefficient (NTC) thermistor I have chosen is the 100-kilohms type, which means that at 77

degrees F (25 degrees C) it has a resistance of 100 kilohms. The resistance of the NTC type falls as it heats up, and the most common types can be used to measure temperatures from below 32 degrees F (zero degrees C) to just above water's boiling point at 212 degrees F (100 degrees C), depending on the type of NTC available. They are available with 10 and 47 kilohms resistance as most common, but other values are available, as well. There are also positive temperature coefficient (PTC) thermistors manufactured with opposite abilities, though not generally as common.

LDRs

Light dependent resistors (LDR) rely on light to change their resistance. Typical resistances for darkness could be 500 kilohms to many megohms that decrease to a few thousand ohms in bright light. Some may even go as low as a few tens or hundreds of ohms, depending on the manufacturer and quality.

Both the thermistors and LDRs have a maximum current rating, and if, for example, a very bright light or hot temperatures are encountered, the resistance of the device may approach zero ohms. In this case, make sure opposing resistors used do not allow the device's maximum current rating to be exceeded. It is a good idea to try to match the opposing resistor to the device used.

For a 100-kilohm NTC thermistor, use a 100-kilohm resistor, or, if you need to have an LDR sense the difference in very low levels of light, you may like to try a 500-kilohm or a one-megohm resistor. This will keep the range you wish to cover in the center position of the VR1 pot. A minimum of one kilohm for an opposing resistor will keep the maximum allowable current to 12 mA. This should be enough to cover any unusual situations. The VR1 pot may be in full lock, though, so try to balance the resistances to a 50/50 ratio within your application.

Figure 1. For the optional LDR shown to the left, try a 500-kilohm resistor (R5).

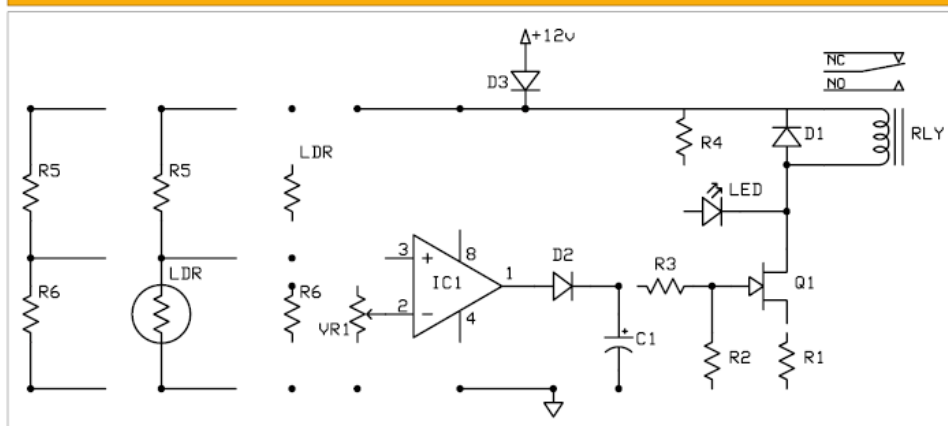

Circuit Description

The circuit was designed to run on 12 volts DC, but could be made to run on six or 24 volts with a few resistor changes, depending on relay availability. The LM358 low-power, dual-operational amplifier chosen can run from a single supply voltage, as opposed to split supply, e.g., ± 12 volts. The LM358 has

an output swing of almost full rail to rail; here it is 12 volts positive to zero volts negative. Only half of the LM358 is used here for all configurations.

The op-amp is set up as a non-inverting comparator in any of the configurations. This means that it will toggle the output of the LM358 high whenever the inverting, negative input, Pin 2, is more negative than the voltage at its positive input, Pin 3. Otherwise, it will toggle the output low when vice-versa input voltages are applied. Via VR1, the negative input can be set to sense any voltage from rail to rail and positive to negative (except in the sound-activated configuration which is highly biased toward the negative rail). The transition between high and low output on the LM358 only needs one of the inputs to be around five millivolts higher or lower, which is very sensitive. The output of the microphone is around 100 millivolts at its maximum output.

The output of the LM358 passes through D2 IN4148, then charges up C1 (a 1 μ F electrolytic capacitor), which acts as a one second sample and hold. It can't discharge back through D2, but only through R3 by increasing the value of C1 to about 47 μ F. As a result, you will get a very long latching effect, close to one minute in length.

Originally, I thought a junction field-effect transistor (JFET) might be able to drive the relay, but instead I found a much better option, the 2N7000. Therefore, R1 was left onboard. The reason for this is that field-effect transistors (FET) draw very little current to switch fully; they rely mainly on the voltage on their gates to work. Usually, JFETs need a negative voltage on their gates to turn off fully (below the actual zero or negative rail), but the 2N7000 metal-oxide semiconductor field-effect transistors (MOSFET) are much easier to use. Most JFETs don't have enough drive capability for a relay anyway.

The 2N7000 does not need the negative gate bias. It is actually an N-channel-enhancement-mode MOSFET. A bi-polar transistor is unsuitable in this circuit (mainly for the microphone version), as it needs too much base input current to operate correctly, but a FET that only needs voltage works fine.

This particular FET can handle up to +30 volts on its gate input, but it can't have any current driving it. More than a few milliamps will kill these devices very quickly.

The R1 serves several purposes. To save power, it reduces the current drawn by the relay, which may be an advantage if a battery supply is used. Also, it

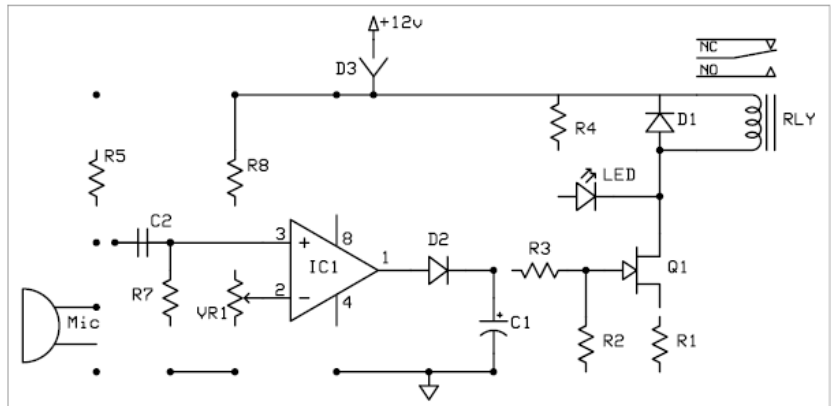

Figure 2. The mic's FET needs to be powered via R5, a 22 kilohm resistor.

can be used to run the circuit a few volts above the relay voltage if needed. R1 could be replaced with a wire link. The voltage drop across R1 does not affect the relay (it could be replaced with a wire link), while a 200-ohm resistor would be enough to stop the relay from fully energizing.

Other TO-92 Package MOSFET Devices that may work are the following:

- Vishay, TP0610L/VP0610L/BS250, I/DS around 180 mA.
- VN0300L, I/DS around 200 mA.
- Fairchild BS170, I/DS around 500 mA.

Check for correct pinouts before using other devices. These devices can be damaged by static electricity; take care.

If an LM358 op-amp is not available, you could try one of the many dual eight-pin op-amps, as long as it can run on a single supply voltage and has a reasonable O/P voltage swing. Just check the spec sheet on any other device you decide to use, as many of these dual op-amps are pin-for-pin compatible.

Table 1. This table is for R5 and R6 at 12 volts DC.

High Side + Low Side - Voltage = the value at the resistor's junction to the zero-to-negative rail.		
R5 = 10K Ω	R6 = 100K Ω	Voltage = 10.9 V - 11.0 V & above = ON, 10.8 V & below = OFF
R5 = 15K Ω	R6 = 82K Ω	Voltage = 10.1 V - 10.2 V & above = ON, 10.0 V & below = OFF
R5 = 22K Ω	R6 = 68K Ω	Voltage = 9.0 V - 9.1 V & above = ON, 8.9 V & below = OFF
R5 = 33K Ω	R6 = 56K Ω	Voltage = 7.5 V - 7.6 V & above = ON, 7.4 V & below = OFF
R5 = 39K Ω	R6 = 47K Ω	Voltage = 6.5 V - 6.6 V & above = ON, 6.4 V & below = OFF
R5 = 47K Ω	R6 = 47K Ω	Voltage = 6.0 V - 6.1 V & above = ON, 5.9 V & below = OFF
R5 = 56K Ω	R6 = 39K Ω	Voltage = 4.9 V - 5.0 V & above = ON, 4.8 V & below = OFF
R5 = 68K Ω	R6 = 33K Ω	Voltage = 3.9 V - 4.0 V & above = ON, 3.8 V & below = OFF
R5 = 82K Ω	R6 = 22K Ω	Voltage = 2.5 V - 2.6 V & above = ON, 2.4 V & below = OFF
R5 = 100K Ω	R6 = 10K Ω	Voltage = 1.09 V - 1.19 V & above = ON, 0.99 V & below = OFF

For a higher impedance input, use the same ratio of resistance, but multiply $\times 10$; e.g., for 10.1 V R5 = 150K Ω , R6 = 820K Ω .

The higher the overall resistance, the less supply power consumed.

These are only a few of the available voltages; by using the E24 range of resistors, many more are available. Experiment!

Which Sensor to Use ... Have You Decided Yet?

Electret Microphone

The Electret microphone has a small FET inside it that needs to be powered. This is supplied via R5, a 22 kilohm resistor. When sound is detected by the microphone's element (a tiny capacitive-plate-charged disk inside), the built-in FET amplifies the tiny signal and it is modulated against the supply voltage from R5. Capacitor C2 (0.22 μ F) picks up this tiny modulated voltage and passes it to the LM358's non-inverting positive input.

The sound-activated section has very little output swing, so R7 is used to tie the non-inverting input very loosely low to prevent the LM358 from toggling when no input signal is present (but with minimal loading on C2).

Using sound as the triggering source for the op-amp has some drawbacks because it is not very constant. In reality, the positive input detects the audio peaks, which can move in the kHz range and is not good for switching any relay on or off. Hence, C1 is used. Also, because the incoming microphone voltage has a very small swing, R8 (at one megohm) is used to effectively stretch the voltage scale in the window that the negative, inverting input of the LM358 is referencing.

D1 prevents reverse voltage when the relay disengages from destroying the FET. The LED has a 1.2 kilohm current-dropping resistor.

To select the LDR input for decreasing light, toggle "ON." For the thermistor to sense less heat, toggle "ON."

The opposing resistor is tied to high, positive, and the sensor is tied to low, negative. Here on R5, a 100 kilohm resistor is used. R6, C2, and R8 are wire links, and the dotted line under C2 is not used here. R7 is omitted.

The microphone input, R5 (at 22 kilohms) and R6, is a wire link. The dotted link under C2 (0.22 μ F) is not used, and R8 is one megohm. For R7, 10 megohms is only used here.

To use five-volt logic to turn on the relay, attach a 10 kilohm resistor to -R6 and a 100 kilohm resistor to +R5. The junction of these should produce just over one volt to ground, which will hold the positive input of the IC1 logic low until the five-volt logic arrives. If you need a higher impedance, try a ratio of 100K Ω /1M Ω . To use an inverted logic voltage, just swap the high and low resistors or try R5 = 56K Ω , R6 = 39K Ω . This will hold the LM358 non-inverting, positive input high until the logic low arrives. Now, use a wire link instead of C2 and make (also) the dotted line below it, R8, a wire link. Both input terminals now become the positive input signal. You'll need a ground point for this input, and there is a spare pad available just below R6. R7 is omitted. Adjust VR1 to set the exact voltage level needed. (Both of the usual input terminals become linked to provide a junction point for R5 and R6.) Both C2 and the dotted line under it need to be wire links here.

Using the Voltage Divider Option as the Input

To activate the relay using any input voltage from zero to 12 volts (user defined), select the input voltage to be just above for ON or just below for OFF. R5 and R6 then hold the positive input of the LM358 slightly higher or lower than the incoming, user-defined input-voltage signal, allowing the relay to toggle on or off when it does. Fine tune this using VR1, which may end up being very offset the closer you get to the positive or negative supply rails.

Voltage Divider Definition:

Two resistors in series connected across a voltage source. The voltage at the common junction is a fraction of the total applied voltage, determined by the resistor values.

eg: Pos Neg = < side connected to
 $10K\Omega + 10K\Omega = 1/2$ -supply voltage
 $2K\Omega + 8K\Omega = 3/4$ -supply voltage
 $8K\Omega + 2K\Omega = 1/4$ -supply voltage

All are measured between the junction and the Neg/Zero supply rail. You can have more than two resistors. Three resistors, for example will produce a window voltage; eg., 20 volts supply, $10K\Omega + 5K\Omega + 10K\Omega$ will produce "four volts" across the five kilohm resistor — $2/5 + "1/5" + 2/5$ of the total supply. But this voltage has no direct reference to either supply rail, as it is floating somewhere in between.

The Standard for checking Capacitors in-circuit



Good enough to be the choice of Panasonic, Pioneer, NBC, ABC, Ford, JVC, NASA and thousands of independent service technicians.

Inexpensive enough to pay for itself in just one day's repairs. At \$199, it's affordable.

And with a 60 day trial period, satisfaction guaranteed or money-back policy, the only thing you can lose is all the time you're currently spending on trying to repair all those dogs you've given up on.

CapAnalyzer 88A

Available at your distributor, or call 561-487-6103

Electronic Design Specialists

Locate shorted or leaky components or conditions to the exact spot in-circuit

Still cutting up the pcb, and unsoldering every part trying to guess at where the short is?



\$199

Your DVM shows the same shorted reading all along the pcb trace. LeakSeeker 82B has the resolution to find the defective component. Touch pads along the trace, and LeakSeeker beeps highest in pitch at the defect's pad. Now you can locate a shorted part only a quarter of an inch away from a good part. Short can be from 0 to 150 ohms

LeakSeeker 82B

www.eds-inc.com

Voltage Cut Out/In Setup

Here, a zener diode and resistor take the place of R5 and R6. To use the relay as a low-voltage cut out/in for a 12-volt-car, NiCad, NmHi, or other battery, you will need a zener diode and a resistor — one to 10 kilohm — as the value isn't critical. The zener needs to be at least a volt or so lower than the cut out/in voltage you want to use.

Low voltage cut out

Setting: zener to positive, reversed biased, of course, resistor to negative. Drop the total supply to the voltage needed and set VR1 just OFF. Restore full supply voltage, when the supply is reduced to the cut-out voltage, the relay will go OFF.

High voltage cut off

Setting: zener to negative, still reversed biased, resistor to positive. Raise the total supply to the voltage needed; set VR1 just OFF. Lower the supply voltage. When supply is raised to the cut-out voltage, the relay will go OFF. Here, C2 is a link and the dotted line below it, R8, is a link. R7 is omitted, and the input terminals are not used here.

Table 2. Thermistor Resistance/Temperature Resistances.

10kΩ Thermistor was used here.

69KΩ	= 14°F or -10°C
37KΩ	= 32°F or 0.0°C — Freezing point of water.
21KΩ	= 50°F or 10°C
13KΩ	= 68°F or 20°C
10KΩ	= 77°F or 25°C — Rating (10KΩ NTC) is taken from here at 25-degrees C.
7.8KΩ	= 86°F or 30°C
5.0KΩ	= 104°F or 40°C — Try to match the opposing resistor to the sensors
3.3KΩ	= 122°F or 50°C resistance value at the temperature or light level.
2.2KΩ	= 140°F or 60°C This gives a better ± pot rotation.
590Ω	= 212°F or 100°C — Boiling point of water = 20 mA current flow at 12V.

Note this configuration will only work for voltages around ±3 volts at 12 volts and around ±2 volts at six volts, where you will need a six-volt relay. The circuit has to have enough voltage to activate the correct voltage relay, but not so much as to cook the relay. Try bypassing R1 if you're under the relay voltage or leaving it in place if just over the relay voltage.

Now, because the supply voltage is not constant in both the above instances and the zener is, the zener becomes the only constant in the circuit. The circuit is virtually flipped upside down with the zener becoming the reference and the rest of the circuit becoming the varying

RF MODULES

WWW.ABACOM-TECH.COM

ABACOM
Technologies

Tel: +1(416)236 3858
Fax: +1(416)236 8866
abacom@abacom-tech.com

Simply Simple.

Call or visit us online

New Products
New Suppliers
New Technologies
New Catalog Every 90 Days!

(800) 346-6873 www.mouser.com

Mouser® and Mouser Electronics® are trademarks of Mouser Electronics, Inc.

input. That's the easy explanation!

Assembly

The assembly should be fairly straightforward, as there are not that many components. Take the usual precautions to check component polarity and orientation. A protection diode, D3 1N4004, was added at the last minute; it could be bypassed/bridged, if you like. There are microphone mounting pads beside each input screw terminal pad, but you might like to use fine wire to mount the microphone until you work out the sensitivity you need. If you need maximum sensitivity, mount the mic off the printed circuit board to prevent the relay vibration from false triggering itself. If a nine mm pot is unavailable, use a five mm trimmer pot.

Testing the Sound Activated Section

All testing should be done with C1 (1 μ F) omitted; this will make it easier to see what's going on, as VR1 set

to about three-quarter-clockwise position should give maximum sensitivity. Rotating it clockwise a little bit will fully toggle on the LM358 output, while rotating counter-clockwise will give a gradual gain reduction due to R8. Without it you would get a drastic gain reduction that would instantly snap OFF.

Once IC1 goes briefly high, C1 holds this voltage for a second or so, preventing the relay from trying to switch at audio frequencies. C1 also helps smooth out any relay chatter that can occur when using an LDR at the transition point; an incandescent light source can cause this.

When setting up the microphone version particularly near the very maximum sensitivity end of the scale, move VR1 slowly and allow a second or so for the circuit to settle for best results. The sound activated relay version was not designed to activate with constant low-level speech, as this would make the circuit unusable in a practical sense (it would be constantly going on or off). The circuit needs a slight audio peak to trigger. The best response is from percussion-type sounds mostly — clicks, pops, thumps, etc. In some cases, the relay clicking on and off

may re-trigger itself. Vibration travels fairly well through a circuit board; I have had the relay coil singing to the microphone in a feedback loop. The sensitivity of the circuit may be increased slightly by mounting the microphone off the circuit board.

If you need to have the sensor or microphone some distance away from the circuit board, you should use shielded wire to avoid any noise induced into the cable. The pad below R6 can be used for the shield wire in this case.

Testing the LDR/Thermistor Activated Section

As mentioned earlier, try to get a balanced resistor/sensor resistance. This will give you a better \pm rotation (midway) on VR1 for fine-tuning later. As a starting point, you may like to measure the resistance of the LDR or thermistor at the temperature or light level you want the relay to activate at, then pick a resistor that is close to this value.

If you happen to end up with a very low resistance on

Parts List

R1	100 Ω , see text
R2	1 M Ω
R3	33 K Ω
R4	1.2 K Ω
R5	22 K Ω mic only or 100K Ω , see text
R6	100 K Ω or link, see text
R7	10 M Ω sound option only
R8	1 M Ω or wire link for thermistor/LDR/voltage
VR1	100 K Ω 9 mm pot or 5 mm trimmer linear — RadioShack Cat # 271-284 (5mm)
Thermistor	100 K Ω NTC or see text — RadioShack 10 K Ω NTC Cat # 271-110
LDR	ORP12 or equiv. — RadioShack Cat # 276-1657
C1	1 μ F electrolytic, see text
C2	0.22 μ F monolithic, mic input only — RadioShack 1.0 μ F Cat # 272-109
D1 D3	1N4004 — RadioShack Cat # 276-1103
D2	1N4148 — RadioShack Cat # 276-1122
Q1	2N7000 N-channel MOSFET or equivalent
IC1	LM358 op-amp
LED	Color, your choice
Mic	Electret microphone, two-wire — RadioShack Cat # 270-90
REL	DPDT 12 V DC relay or 5 V, 6 V, 24 V DC if available
Terminals	PCB mount screw terminals, 1 x 6 or 2 x 2 for professional looking job.
PCB	Clinch universal relay PCB

To fit the project in a small box, a low-profile relay is needed; they are available at slightly higher cost. You may also need to do a small amount of filing near the PCB mounting holes to clear the internal lid mounting pillars of the box. The VR1 pot needs a small hole drilled in the lid to protrude through or cut its shaft down slightly, but be careful. You may also want a hole for the LED.

If you're using an IC socket, please use a machined pin type. Six- and 24-volt relays are also available; with a few resistor changes, you could run the board at five, six, or 24 volts DC.

If you feel the need to correctly terminate the unused op-amp in the LM358, you could have a look at this web page: www.maxim-ic.com/appnotes.cfm/appnote_number/1957

The components are commonly available at the usual electronic suppliers. I can supply a quality PCB with top overlay and solder mask for the project.

Price: PCB @ \$8.00 each, including GST, plus \$4.00 P&H in Australia. Prices may come down; check website for availability.

your sensor, you can cheat a little by adding a one- to 10-kilohm resistor in series with the sensor, but also add an equal value to the fixed resistor. Try some experimenting with resistor values; you can get quite creative and produce very wide or narrow windows for temperature sensitivity, etc. Just remember sensor current ratings, though. Remember to maintain a 50/50 sensor/resistor ratio for better $\pm VR1$ rotation.

Table 2 shows some examples of thermistor resistance/temperature resistances. Don't forget to replace C1 after setup.

If you are interested, the relay can be made to self-latch by taking the spare pad between the relay and VR1 and connecting it to one of the relays' normally open (NO) terminals. Linking pads are provided onboard. The matching "C" common terminal is then taken to the Neg supply rail. By doing this, you effectively bypass the FET Q1 after it has initially engaged the relay. You need to insert a switch in this connection to break the circuit to release the relay and reset it.

The current rating of the left-hand set of relay contacts is only rated at around two amps due to the circuit board

The Applications are Limitless, So Get Your Imaginations Into Gear and Have a Go!

Possible uses could include:

- Battery protection for cars, low voltage accessory cutout
- Battery charger (NmHi, NiCad, SLA) cutout/warning, heat monitoring, overvoltage
- Baby monitor using microphone input
- Garden light controller, sunset activation
- Aquarium/incubator heater control or failure warning
- Power failure warning (battery backup supply needed), use voltage divider input
- Fire warning, connected to security system
- Intruder sensor; use LDR/LED beam, etc., in a security system
- Hand clap activated switch, breaking glass sensor in a security system
- Peltier device control, fridge, or incubator
- Garage door opener (LDR in a tube), set to activate with car high beam lights
- Voice-activated switch for an intercom, CB radio, transmitter, etc.
- Computer automation of other devices using logic voltages
- Toxic gas detection using a metal oxide range of gas detection sensors

track width. The circuit draws just under one mA at 12 volts on standby, 45 mA with the relay and LED on, and about 62 mA if you use the latching option when the FET is bypassed.

Note: For best results, use a regulated power supply, with microphone option especially. **NV**

GREAT ROBOTS. GREAT PRICES.

(Shown with optional controller)



RIGEL

- 4WD - 4 servo motors!
- Rugged construction
- High traction over carpet, concrete, grass, and more!
- Nibbed rubber tires (2.5")
- Multiple 1/4" thick decks
- Over 60 square inches of mounting space
- Measures 6.75 x 5", and 4.5" tall
- Available in colors
- Add your own microcontroller, sensors, video camera, GPS, or other electronics

BUDGET ROBOTICS
Robots for the Rest of Us

WWW.BUDGETROBOTICS.COM

USB DAQ

LabJack U12

Available now for only ...

\$119 qty 1
(\$99 qty 10+)

USB Data Acquisition & Control

- * Built-in screw terminals
- * Easy-to-use USB
- * Everything included
- * Use with C, VB, LabVIEW, etc.
- * Windows 98SE/ME/2000/XP
- * 12-bit analog inputs (8)
- * 10-bit analog outputs (2)
- * 20 digital I/O
- * 32-bit counter

Made in Colorado, USA, by LabJack Corp.
info@labjack.com, (303) 942-0228

www.labjack.com

The Nuts & Volts Hobbyist Bookstore

Microcontrollers

Programming & Customizing PICMicro Microcontrollers

by Myke Predko

This book is a fully updated and revised compendium of PIC programming information. Comprehensive coverage of the PICMicros' hardware architecture and software schemes will complement the host of experiments and projects making this a true "learn as you go" tutorial. New sections on basic electronics and basic programming have been added for less sophisticated users, along with 10 new projects and 20 new experiments. The CD-ROM contains all source code presented in the book, software tools designed by Microchip and third party vendors for applications, and the complete data sheets for the PIC family in PDF format. **\$49.95**

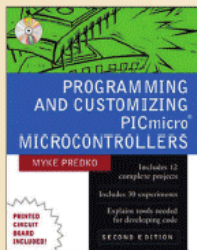

PICMicro Microcontroller Pocket Reference

by Myke Predko

Device, code, and circuit data on one of the most popular microcontrollers around — it's in your pocket with this guide. You'll never again get stuck in the World Wide Wait or shuffle through coffee-stained printouts, looking for the facts you need. Short on verbiage and long on facts, this is the ideal data tool for the experienced applications designer. **\$29.95**

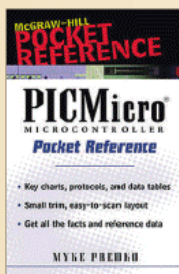

Programming & Customizing the 8051 Microcontrollers

by Myke Predko

For work or fun — projects, exercises, and insights on the world's most popular microcontroller. Over 30 experiments and 13 complete projects demonstrate the 8051's capabilities. The CD-ROM gives you all the software you need to begin developing 8051 applications. This tutorial/disk package is unique in providing you with a complete understanding of the 8051 chip compatibles, along with all the information needed to design and debug tailor-made applications. *Programming & Customizing the 8051 Microcontroller* details the features of the 8051 and demonstrates how to use these embedded chips to access and control many different devices. **\$44.95**



Robotics

CNC Robotics

by Geoff Williams

Written by an accomplished workshop bot designer/builder, *CNC Robotics* gives you step-by-step, illustrated directions for designing, constructing, and testing a fully functional CNC robot that saves you 80% of the price of an off-the-shelf bot — and can be customized to suit your purposes exactly because you designed it. **\$34.95**

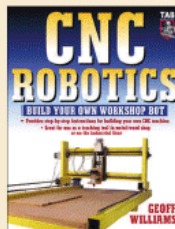

Robotics Demystified

by Edwin Wise

McGraw-Hill's *Demystified* titles are the most efficient, interestingly written brush-ups you can find. Organized as self-teaching guides, they come complete with key points, background information, questions at the end of each chapter, and even final exams. This complete self-teaching guide takes an introductory approach to robotics, guiding readers through the essential electronics, mechanics, and programming skills necessary to build their own robot. **\$19.95**



123 Robotics Experiments for the Evil Genius

by Myke Predko

This book provides 123 steps needed to bring out the genius in every basement hobbyist! If you enjoy tinkering in your workshop and have a fascination for robotics, you'll have hours of fun working through the 123 experiments found in this innovative project book. Each experiment builds on the skills acquired in those before it, so you develop a hands-on, nuts-and-bolts understanding of robotics — from the ground up. Don't miss out on these imaginative experiments that teach the basics! **\$24.95**

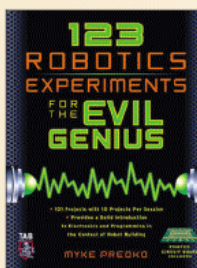

Electronics

Build Your Own Electronics Workshop

by Thomas Petruzzellis

The Electronics Workbench was created to assist the newcomer in the field of practical electronics through the creation of a personal electronics workbench. It is a place specially designed so that readers can go there to work on an electronic project, such as testing components, troubleshooting a device, or building a new project. The book includes invaluable information, such as whether to buy or build test equipment, how to solder, how to make circuit boards, how to begin to troubleshoot, how to test components and systems, and how to build your own test equipment, complete with appendix & resources, etc. This is *THE* book for anyone entering the field or hobby of electronics. **\$29.95**

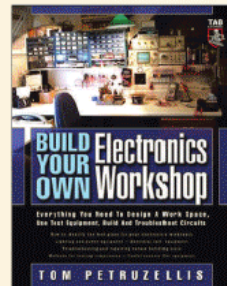

Engineer's Mini Notebook Collection

by Forrest M. Mims III

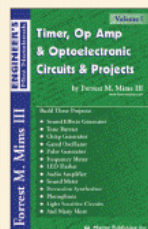

Volume 1 features more than two dozen 555 timer circuits that you can build. **\$10.95**



Volume 2 — Study rain, lightning, clouds, sunlight, water, temperature, and much more! **\$10.95**

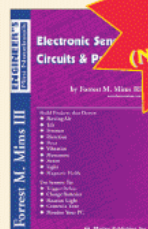

Volume 3 — Learn about important sensors and use them to build circuits and projects. **\$10.95**

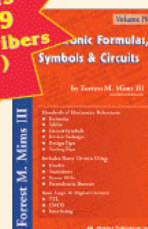

Volume 4 includes frequently used electronic formulas, tables, circuit symbols, and more! **\$10.95**

All Four Volumes \$39.99 (NV subscribers ONLY!)

WE ACCEPT VISA, MC, AMEX, and DISCOVER
Prices do not include shipping and may be subject to change.
Ask about our 10% subscriber discount on selected titles.

Call 1-800-783-4624 today! Or
order online at www.nutsvolts.com

Practical Electronics for Inventors

by Paul Scherz

The first edition of *Practical Electronics for Inventors* was phenomenally successful and popular among electronics hobbyists and "tinkerers." This is a fairly "tight" group, and when they noticed some errors in the book, they were fairly vocal in wanting to see errata. The result? A new and improved book that has been completely updated, with several readers' suggestions for improvement incorporated inside. These new additions will make this title even **MORE** appealing to the loyal market. **\$39.95**



Electricity Demystified

by Stan Gibilisco

In *Electricity Demystified*, best selling science and math writer Stan Gibilisco provides an effective and painless way to improve your understanding of the electricity that powers so much of modern life. With *Electricity Demystified*, you master the subject one simple step at a time — at your own speed. This unique self-teaching guide offers quizzes and tests at the end of each chapter, and section to pinpoint weaknesses, and a 70-question final exam to reinforce the entire book. If you want to build or refresh your understanding of electricity, here's a fast, entertaining, self-teaching course that's really electrifying! **\$19.95**

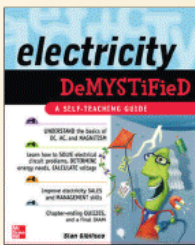

Electronics Demystified

by Stan Gibilisco

Now anyone with an interest in electronics can master it by reading this book. In *Electronics Demystified*, best selling science and math writer Stan Gibilisco provides an effective and painless way to understand the electronics that power so much of modern life. With *Electronics Demystified*, you master the subject one simple step at a time — at your own speed. This unique self-teaching guide offers problems at the end of each chapter, and a section to pinpoint weaknesses, and a 70-question final exam to reinforce the entire book. If you want to build or refresh your understanding of electronics, here's a fast and entertaining self-teaching course that's completely current. **\$19.95**

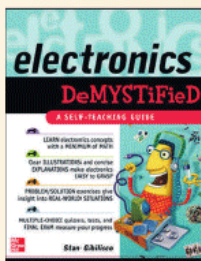

Digital Electronics Demystified

by Myke Predko

Now, anyone can gain a deeper understanding of digital electronics — without formal training, unlimited time, or a genius IQ. In *Digital Electronics Demystified*, electronics expert and author Myke Predko provides a totally painless way to learn enough digital logic and electronics to build your own projects! With *Digital Electronics Demystified*, you master the subject one simple step at a time — at your own speed. This unique guide offers problems at the end of each chapter and section to pinpoint weaknesses and a 100-question final exam to reinforce the entire book. So, if you're looking for an enjoyable route into digital logic and electronics, let *Digital Electronics Demystified* be your short-cut! **\$19.95**

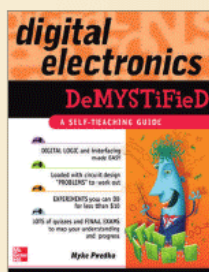

Electronic Circuits for the Evil Genius

by Dave Cutcher

In *Electronic Circuits for the Evil Genius*, the reader gains valuable experience in circuit construction and design and in learning to test, modify, and observe results. Bonus website www.books.mcgraw-hill.com/authors/cutcher provides animations, answers to worksheet problems, links to other resources, WAV files to be used as frequency generators, and freeware to apply your PC as an oscilloscope. **\$24.95**

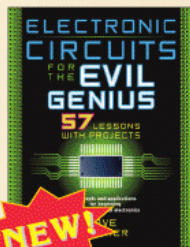

Home Computing

USB Complete, Second Edition

by Jan Axelson

Every recent PC has Universal Serial Bus (USB) ports. In *USB Complete*, Jan Axelson shows how to design and program devices that use USB to communicate with PCs. Learn how to select a USB controller chip that fits your project and budget, how to write program code to manage USB communications in your device, and how to write Visual Basic and Visual C++ applications that exchange data with your devices. Explore how the interface works from the ground up and learn how to create devices that communicate reliably with all PCs. **\$49.95**



The PC Doctor's Fix It Yourself Guide

by Adrian Kingsley-Hughes

In *The PC Doctor's Fix It Yourself Guide*, you get advice and solutions for solving a myriad of PC problems, including expert tips on researching solutions on your own. Learn how to maintain your computer, keeping it in good working condition, and how to upgrade and install new software safely. Troubleshoot Linux, Windows, and personal devices, use the Internet effectively as a problem-solving tool, get up to speed on computer security, and set up small home and wireless networks. The companion website provides additional support. **\$29.99**

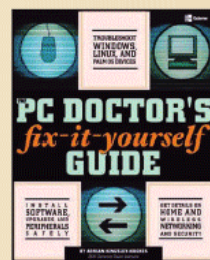

Embedded Ethernet and Internet Complete

by Jan Axelson

Learn how to design and program devices that host Web pages, send and receive e-mail, and exchange files using FTP. Put your devices on the Internet and monitor and control your devices from across town or around the world. Or create private, local networks that enable your devices to share information, send commands, and receive alarms and status reports. Plus: learn about Ethernet controllers, hardware options for networks, networking protocols, and how to keep your device firmware and data secure. **\$49.95**

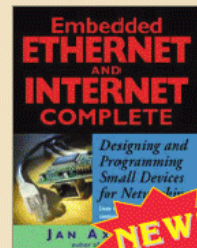

High Voltage

Homemade Lightning: Creative Experiments in Electricity

by R. A. Ford

Enter the wide-open frontier of high-voltage electrostatics with this fascinating, experiment-filled guide. You'll discover how to make your own equipment, how electricity is used in healing, and how experiments in high potential physics work! **\$24.95**

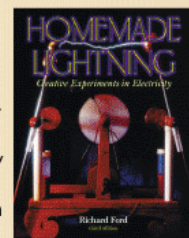

If you don't see what you need here, check out our online store at www.nutsvolts.com for a complete listing of the titles available.

25 Watt UHF RF Power Amp

New, heavy duty UHF power amp assembly. 10 mW in for 25 W out! Commercial quality with built in PIN antenna switch and low pass filter. Tuned for 550MHz, add 5 parts (included) for 440 MHz Ham band. On big 1" thick 3 lb aluminum heat spreader!!
0133086R\$49.95



Electroluminescent Light Panel

Electroluminescent light panel as used in LCD backlights, runs on 75 140 VAC. Soft green glow, ideal for nite lights or fancy light ing projects, runs great on regul ar AC line voltage. Size 2.75" x 1.25" and just a few hairs thick! Super neat great project item!!
0133512R Bag of 25 pcs!.....\$5.95



CCFL Florescent Light Inverter



New power inverter drives 2 lamps up to 5W each! Simple to use, 12 VDC in, connect florescent lamps to output. Module generates correct starting and operating voltage, lamp current and is even dimmable!
0128520R\$9.95

erates correct starting and operating voltage, lamp current and is even dimmable!

Laser Scanner Bar Code Module



Wow! What a cool item! Brand new laser scanner module (size 1x1x1.5") includes red laser, beam splitting mirror, opamps, photo sensor, transistors, processor, ICs, etc. From handheld laser barcode reader. We sold out of the last style we had! No specs, but buyers figured out the hook up for the last group, we'll post on the web any new info on this one, should be easy, has just 12 pins on the connector. Styles may vary.
0131346R\$14.95

Piezoelectric Alarm



WOW, is this thing LOUD! Runs on 2 12 VDC and draws mere milliamps, 103db output! Rotating bezel allow easy volume control too! 1.25" dia and 1.5" long.
Google for specs: Bell Audiolarm XC V09 212 S
0132165R\$4.95

Watch Camera Button Battery

Popular watch/photo battery at a dynamite price! Brand new Eveready EPX76/SR44 same size as LR44/AG13 as used in laser pointers, toys etc but Silver Oxide with better life and specs at the store, these go for over \$2 each!!
0133087R Big tray of 100 pcs!!.....\$9.95



Windsor

WINDSOR DISTRIBUTORS COMPANY
19 Freeman Street
Newark, New Jersey 07105 3708
Ph: 973 344 5700 Fax: 973 344 3282



ORDERING INFO: Shipping and insurance charges made after order is packed. You will be notified by Email. Orders under \$25 add \$5.00 small order fee. Credit cards will only be authorized on US and Canadian banks. Please contact Windsor regarding payment instructions for other countries.

LED BLOWOUT !!!



Here's a deal that just will not last long. Windsor's LED Blowout! Super high quality, factory prime bright LEDs. Ideal for all those projects that you've wanted to build, but just didn't have the quantity of LEDs needed. You will not find pricing like this ever again - we bought out two factory inventories! Here's the scoop: Big bag o leds have 500 pcs and are all RED jumbo 5 mm size with crystal clear bulbs. You pick the luminous intensity, bear in mind that the 2500 mcd high bright units are flashlight intense! Big buyers will love the 2,000 LED boxes! These LEDs are the smaller T 1 size with full leads, available in Red or Green. Imagine 2,000 Leads for less than a penny each!

0131288R High Bright 500pc bag \$19.95
0131292R Standard Bright 500 pc bag \$14.95
0130956R Box o leds Red 2,000pcs \$19.95
0130955R Box o leds Green 2,000pcs \$19.95

Windsor's Blue LED Special



Holy Smokes! Can you believe the price on this BLUE LEDs? First quality from our factory buyout. Big and bright! These normally sell for \$1.50 each and that's in big quantities! We're crazy to sell 'em so cheap!!

0131297R 50pcs \$19.95
0131297 500pcs \$99.95

Laser Fiber Optic Transmitter

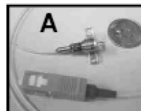

Brand new HP Agilent model LST2829 Laser transmitter module. Capable of 622 MB/s data rates, 1 mW output power, 1300 nm wavelength, includes on chip power monitor diode. These are high end quality lasers and not often found on the surplus market! Two style available, A: 32" long thin pigtail fiber and B: 16" long encased fiber. Each has the same electrical specs. Price: \$9.95 each
Item A: 0128526R Item B: 0128536R

Laser Fiber Optic Transceiver

New, by Infineon. Has laser transmitter and receiver in one package! 1.25 Gb/s data rate up to 700 M on low cost multi mode fiber! Super small size, complete specs on the web. Make your own fiber optic link!
0125461R (Set of two)\$19.95



Tiny Beeper Speaker

Star PMX 04B beeper speaker as used in cell phones and pagers. Only 1/2" dia, easily drive from micro or single transistor driver circuit included!
0133088R Group of 5 pcs\$2.00



C size Nicad Battery



This is the real deal, a true 2 A Hr Nicad, Button top works in any device too! Brand new by Sanyo.
0130380R\$2.00

Nicad Battery Stick

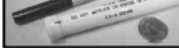

New 4.8 V 500 mA Nicad battery. 0133511R.....\$4.00



Ion Generator

Its super easy to build your own Ion Breeze air purifier! New module, 120 VAC in, 7.5KV out! Surplus from air cleaner maker who sold them for \$200!
0128873R\$7.95

Rechargeable Battery Blowout!



Popular Nicad batteries, 1.25V All brand new. A, B, D are NiCad, C is NiMH. A has no sleeve.
A: AAA 400mah 0125339R 2 for \$1.00
B: AAA 250 mah 0133089R 5 for \$3.00
C: 3.6 Volts 750mah 0125348R 2 for \$3.00
D: AA 700mah 0132163R 5 for \$3.00

Nicad Battery Pack

Brand new high power density rechargeable battery pack. 6 volts, 650 mahR. Space saving rectangular shape approx 2x1x0.75" with 6" wire leads.
0132161R\$4.95



Nice, new 5 AA cell nicad pack. 6 Volt 700mah with 6" wire leads. Great for projects or cordless phone replacements.
0125345R.....\$2.50

Big box of 50 brand new AA button top NiCads. Fit anywhere an AA battery does. 1.25V 800mah. Best price in the USA!
0128870R.....\$19.95



Lithium Ion Rechargeables !!

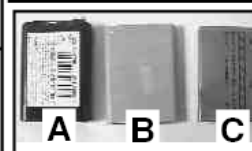

Rechargeable Lithium batteries pack the highest density of power for size and weight! Ideal rectangular size is easy to fit in your project. All 3.6 Volt and approx rated Amp Hour capacity.
A: 1Ah 1.95x1.34x.4" 0125337R.....\$1.50
B: .8Ah 1.95x1.34x.25" 0125349R.....\$1.25
C: .8Ah 1.95x1.24x.23" 0125350R.....\$1.25

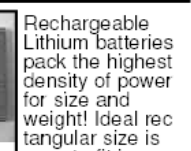

Truck Stereo



New in dash cassette stereo AM/FM radio, LCD display, drives 4 speakers (80 watts!) Even has Weather band! Quality

fully enclosed case, easy hookup, great for in wall home installations! Runs on 12 VDC.
0128872R.....\$29.95

Handy Tool Set

Well made quality 3 piece plier set. Includes deluxe padded zipper case. Pliers are big 8" in size, you get: needlenose, diagonal and lineman style with handy crimper and stripper dies on each tool! Get a few for the car, gifts and toolbox, they are that nice!



0128871R\$12.95

www.shopatwindsor.com

UM-1SL CRYSTALS

Saelig, Inc., announces UM-1SL, a new range of slim crystals designed for use in handheld and portable communications applications, where their small size and profile allows them to be easily incorporated into equipment designs. The new UM-1SL crystals are manufactured in Europe by Euroquartz, and the crystal blank used in the UM-1SL package is capable of being manufactured to close tolerances and is readily produced to custom frequencies and specifications.

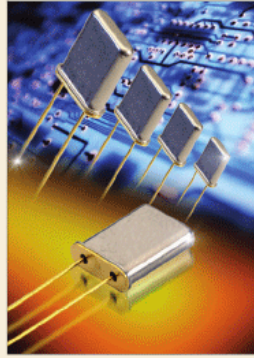

UM-1SL's crystals are housed in a hermetically sealed, low-profile, low-mass, UM-style package, measuring 7 x 8 x 1.8 mm. A wide frequency range is available from eight to 40 MHz in fundamental mode and up to 260 MHz in overtone mode. Specifications include calibration tolerance at 25 degrees C of ± 3 ppm, frequency stability over temperature from ± 2.5 ppm (-10- to +60 degrees C) to ± 20 ppm (-5 to +105 degrees C), shunt capacitance of four pF typical (seven pF maximum), equivalent series resistance from 25 to 80 (depending on frequency), maximum drive-level of 100 mW, and aging of ± 2 ppm maximum for the first year (± 1 ppm maximum per year thereafter). Load capacitance is from eight to 32 pF or can be specified by the customer.

Supplied bulk packed, Euroquartz's new UM-1SL crystals are available for operation over a variety of temperature ranges, encompassing zero to 50 degrees C to -55 to +105 degrees C.

For more information, contact:

SAELIG CO., INC.

Tel **585-385-1750**

Email: info@saelig.com

Web: www.saelig.com

Circle #139 on the Reader Service Card.

TEST PATTERN GENERATOR

Offered exclusively by MCM, the Tenma HDTV/PC Test Pattern Generator (MCM part #72-7985) is the ideal low-cost solution for installation, calibration, and servicing of today's high-resolution display devices. This compact unit provides DVI, PC (VGA through SXGA) and (Y/Pb/Pr) HDTV component video outputs. With the addition of a separately available adaptor cable, this unit is also compatible with HDMI inputs. Features of the Multi-Media Pattern Generator include: 28 static and dynamic video test patterns; PC output resolutions from 640 x 480 through 1280 x 1024 (VGA, SVGA, XGA, SXGA); HDTV output resolutions from 480p through 1080i (480i, 576i, 480p, 567p,

720p, 1080i); simple, intuitive, push-button, on-screen menu control; included cables for connection to DVI, VGA, and component video monitors; and rugged EMI-shielded steel enclosure. The unit is very compact, measuring only 7 x 7 x 1.2 inches.

With a suggested list price of \$650.00, the Tenma HDTV Multi-Media Pattern Generator offers a pattern assortment and quality that is comparable to units costing three times as much. Ease of use and affordability make this unit a must have for virtually every A/V professional.

For more information, contact:

MCM

Tel **800-543-4330**

Web: www.mcminone.com

Circle #44 on the Reader Service Card.

CMOS-BASED VOLTAGE REGULATOR/DETECTOR

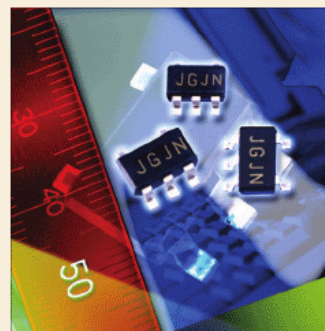

Seiko Instruments' S-1701 series is a CMOS-based device that integrates a voltage regulator and detector into one composite package design.

The small SOT-23-5 and SOT-89-5 package designs provide for high-density mounting and are ideal for applications where installation space is restricted. Typical applications include power supplies and reset circuits for battery-powered devices, power supplies for personal computers, and as power supplies for home appliances.

This robust unit has a ripple rejection ratio of 70 dB, low current consumption, an output voltage accuracy of ± 1.0 percent, and a built-in on/off circuit that prolongs battery longevity. Both the output and detection voltage are selectable in 0.1-volt steps ranging from 1.5 to 5.0 volts and 1.5 to 5.5 volts, respectively. A low ESR 1.0 μ F or more ceramic capacitor can be utilized as the output capacitor.

The regulator block has a built-in over-current protector and an operating voltage range of 2.0 to 6.5 volts, while the detector block has three time-delay settings (no delay, 50 ms, or 100 ms) and an operating voltage range of 0.8 to 6.5 volts.

The S-1701 series of voltage detectors are priced from \$0.38 in quantities of 10,000. Full technical specifications are available at their website.

For more information, contact:

SEIKO INSTRUMENTS

Web: www.sii-ic.com

Circle #65 on the Reader Service Card.

SMART BATTERY MONITOR

Atmel® Corporation introduces the ATmega406, its first high-voltage technology AVR® microcontroller implementing full two- to four-cell Lithium Ion smart battery monitoring and protection on a single chip. Lithium Ion (Li-ion) is the battery chemistry of choice for high-end portable applications such as laptop PCs, cell phones, and digital cameras, due to its high-energy-per-weight-and-volume ratio, combined with a high-load current.

To enable the ATmega406 to be powered directly from a two-, three-, or four-cell Li-ion configuration, the device includes an on-chip voltage regulator allowing the device to be powered from four to 25 volts. It also features three 25-volt-tolerant FET drivers for charge, discharge, and pre-charge, as well as on-chip FETs for cell balancing.

To provide the most accurate estimate of charge left, the device has a Coulomb Counter ADC with an 18-bit output for battery current monitoring as well as a 12-bit ADC for individual cell voltage and temperature monitoring. Both ADCs use high-accuracy on-chip voltage reference. Battery protection is autonomous, providing the end-user with the best safety, as MCU-related issues such as a code runaway or a software bug do not affect it. Adding communication periphery and an efficient MCU architecture, ATmega406 is the first fully configurable single-chip smart battery solution on the market.

Battery protection is implemented as independent circuitry, not requiring the MCU to operate. If the device is exposed to an over-current or short-circuit condition, the autonomous battery protection will shut off the affected FET. Likewise, if any cell voltage drops to a potentially damaging voltage level, ATmega406 will automatically prevent further battery discharge by shutting down

the discharge FET and going to a power-off mode.

A reliable estimate of charge left can be used to extend battery life by allowing the battery to use all its power. The ATmega406's Coulomb Counter and Voltage ADC are custom-made for optimal current and voltage tracking, essential for an accurate and reliable estimate of charge left. The current resolution of the Coulomb Counter over the recommended five-megohm sense resistor is 0.67 mA, allowing measurements of more than $\pm 30A$. Both ADCs benefit from a very accurate internal voltage reference, with less than ± 0.1 percent error over temperature after calibration.

With 40 KB of Flash program memory, 512 bytes of EEPROM for data parameter storage, and two Kbytes of internal SRAM for program data, ATmega406 packs the algorithm processing power necessary to implement battery monitoring and management for a full four-cell laptop PC battery pack configuration. The device includes the SM-bus interface for communication with the host application, and Atmel's self-programming Flash allows battery firmware upgrading through this or any other interface, providing the most flexible design solution on the market.

All parts of the ATmega406 are optimized for extremely low power consumption, drawing less than 1.2 mA in active mode and less than two μA in power-off mode.

A full suite of development tools supports ATmega406, including the JTAGICE mkII emulator, and a smart battery development kit. The ATmega406 is available in LQFP 48-pin packages and pricing starts at \$2.75 for volumes above 100K.

For more information, contact:

ATMEL CORPORATION
 Tel (408) 441-0311
 Email: hmao@atmel.com
 Web: www.atmet.com

Circle #51 on the Reader Service Card.

www.Primecell.com

Battery rebuilding service

Dead Batteries ? Don't toss them. Send them to us - our rebuilds are better than original specifications.



Tools
 Hitachi Skill
 Milwaukee
 Panasonic
 B&D DeWalt
 Makita All
 2-36 Volts

Electronics
 Bar Code
 Scanners
 Surveying
 Printers
 Laptops
 Photography



Radios
 APELCO
 UNIDEN
 G.E. ICOM
 KENWOOD
 MOTOROLA
 MIDLAND
 MAXON
 YAESU
 ALINCO

Visit www.primecell.com for important details

24 Hr Secure recorder tel-fax (814) 623 7000

Quotes email: info@primecell.com

Cunard Assoc. Inc. 9343 US RT 220 Bedford PA 15522

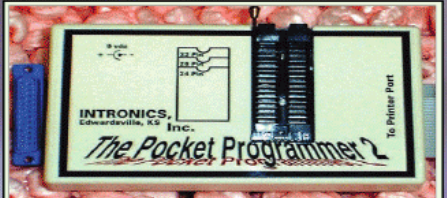

The Pocket Programmer Only \$149.95

The portable programmer that uses the printer port instead of an internal card, with easy to use Windows software that programs E(E)prom, Flash & Dallas Ram.

Intronics, Inc. • Tel. (913) 422-2094
 Box 12723 / 612 Newton / Edwardsville, KS 66111
 Add \$8.00 COD

WWW.IN-KS.COM

Visa/MC/Amex/Disc

Fill Your Basket With a Little Something Extra This Year!



DON'T WASTE ANY TIME!
 Start your subscription to **SERVO Magazine** today!

Call **800.783.4624**

or go online at

www.servomagazine.com

**THE ezVID
COLOR VIDEO
MADE SIMPLE**

THE ezVID SERIAL VIDEO MODULE
 • TRUE BITMAP SCREEN WITH A RESOLUTION OF 188 BY 254
 • 63 BUILT-IN AND 256 USER-DEFINABLE CHARACTERS
 • 14 COLORS TO CHOOSE FROM
 • AND MUCH MORE...

VISIT WWW.MULTILABS.NET TO LEARN MORE
 MULTILABS
 LAKE FOREST, CALIFORNIA

Everything you need
to build your own ...

MOBILE ROBOT

Sonar Units
 Vision Systems
 Motor Drivers
 Optics
 Microprocessors
 Artificial Intelligence
 Web Controls

Zagros Robotics
www.zagrosrobotics.com
 PO Box 460342, St. Louis, MO 63146
 (314) 768-1328 info@zagrosrobotics.com

LITEXPO™ Digital Video Player Board
\$69/ea BUILD YOUR OWN
E-FRAME
 - Plays MPEG1, 2 & JPEG
 - Uses CF Card (optional)

Tel: (847) 303-9700 WWW.LITEXPO.COM

SMT PROTOTYPING ADAPTERS

Snap-Apart™ PCB's with .100" pin strips.
 Dozens of assorted adapters on each PCB.
 A variety of PCB's with patterns front & back.

SOIC PLCC SSOP QFP DPAK SOT23 MSOP QSOP SC90 D2PAK
 TSSOP SOT89 D3PAK SOT143 TSOP SC70 SOT88 and many more.

(BELLIN DYNAMIC SYSTEMS INC)
(714) 630-8024 www.beldynsys.com
 - Rapid Development Solutions for the Technical Professional -

Add Some Industrial I/O to Your
Micro with an I2C Expansion
Card

BSIO I2C 8x8

www.bsio.us

Get the most out of the Rabbit's powerful
feature set with the first reference book
dedicated exclusively to the
Rabbit 3000.

Buy Online
\$49

Embedded Systems Design
Using the Rabbit 3000®
Microprocessor
By Kamal Hyder & Bob Perrin

www.therabbitbook.com

RABBIT Semiconductor

Electronics Showcase

QKITS.COM

VK01 I:
Serial Temp. Sensor Interface: **\$29.95**
 (Price is in US dollars.)

- Power Requirements * 9 - 15VDC (from adaptor or through the serial port)
- Screw terminals for easy connection of up to four Dallas DS18S20 temperature sensors (One sensor included)
- Measures in both degrees C and F
- Adj. sample rate from 1 to 99 sec. or 1 to 99 mins
- Advanced CRC error checking

1-800-GO 4 KITS
 GREAT PRICES, GREAT SHIPPING RATES
 49 McMichael St., Kingston, ON, K7M 1M8

SPRING SALE!

PRINTED CIRCUIT BOARDS

QUALITY PRODUCT
 FAST DELIVERY
 COMPETITIVE PRICING

10 pcs (3 days)
 1 or 2 layers **\$249**
 10 pcs (5 days)
 4 layers **\$695**
 (up to 30 sq. in. ea.)
 includes tooling, artwork,
 LPI mask & legend

* UL approved
 * Single & Double sided
 * Multilayers to 8 layer
 * SMOBC, LPI mask
 * Reverse Engineering
 * Through hole or SMT
 * Nickel & Gold Plating
 * Routing or scoring
 * Electrical Testing
 * Artwork or CAD data
 * Fast quotes

PULSAR, INC
 9901 W. Pacific Ave.
 Franklin Park, IL 60131
 Phone 847.233.0012
 Fax 847.233.0013
 Modem 847.233.0014

We will beat any
competitor's prices!!!
yogii@flash.net • flash.net/~yogii

ActiveWire® USB
Simple USB Interface!

Works with MacOS 8/9, Win98/2K/ME/XP
 FreeBSD and Linux!
 • 24Mhz CPU core with USB
 • Firmware downloadable via USB
 • 16 bit parallel Input/Output
 • See web-site for add-on boards
 • All drivers, manuals, demos are on our web-site for immediate download!

\$59
plus shipping

ActiveWire, Inc.
www.activewireinc.com
 ph +1.650.465.4000 fax +1.209.391.5060

Nuts & Volts ...
 Making waves in the
 future of electronics!

Subscribe
TODAY!
 Call 1-800-783-4624
 or go online at
www.nutsvolts.com

ANDRE LAMOTHE'S
XGAMESTATION
 LEARN STEP-BY-STEP HOW TO BUILD
 AND DESIGN YOUR OWN VIDEO GAME CONSOLE!

Design inspired by the
Atari 2600, Apple II &
Commodore 64!

INCLUDES:
 • Great for Hobbyists AND Students!
 • The Fun Way to Learn Embedded Systems!
 • Fully Assembled XGS Micro Edition Unit!
 • Complete Software Development Kit!
 • Tools, Demos & Utilities!
 • eBook on Designing the XGS Console!
 • Cables and Power Supply Included!

Powered by the Ubicom
SX52 @ 80 MIPS and
Parallel SX-Key Compatible!

WWW.XGAMESTATION.COM
 (925) 736-2098 SUPPORT@NURVE.NET

JK Microsystems µFlashPlus 84-0040 Kit
 Embedded Intel 386EX Board — **Only \$79 each!**

These are **NEW OEM boards** fully restored to factory default condition.
 Our price is **\$100 off JK Micro's list price of \$179 for the board only!**
We include power supply & 4Mb Flash chip at no extra cost! (\$35 value)
 Pre-installed DOS, TCP/IP and Web Server Software
 PC Compatible Serial and Ethernet Ports plus much more!
 Download manual, datasheet, drawings at: <http://www.jkmicro.com>

Northwest Technical, Inc.
www.northwesttechnical.com
 Tel: 541-469-6644 • Fax: 541-469-6655

PIC VIDEO

PART 1: *Video Text Overlay With a PIC Microprocessor*

BY ROBERT LANG

One of the things that has always interested me is the ability to superimpose text on a TV picture. Since the early days of the microprocessor, a way to interact with text has been a requirement. In the days before computer monitors (yes, there was a time), one of the first such devices was Don Lancaster's TV typewriter.

In the late 1970s, if you built your own home computer from a kit, the TV typewriter was one of the few input/output devices available at a reasonable cost, but it could not superimpose text on a picture, only text on a black background. Well, my TV typewriter has been in the closet for many years, and I pulled it out the other day to take a look

at it. The TV typewriter uses 68 integrated circuits to display text on a TV screen, but I think that the chip count can be improved upon with a modern microprocessor.

One of the things I have shied away from since getting involved with electronics is TV interfacing. No doubt, I was scared off by the complexity of the original TV typewriter. To overlay textual information on a TV picture, timing is everything. The microprocessor must put out information at exactly the right point when the proper line on the TV screen is being drawn. Fear not, this can now be accomplished with three integrated circuits. We will build a unit that can superimpose text data on a TV picture and use an RS-232 interface to update the text. After we complete the unit, we will use it to explore the world of subliminal messaging.

Figure 1. The original TV typewriter.



Standard Television

The National Television Standards Committee (NTSC) sets the analog television standard for the US; this format itself is also informally called NTSC and is described on their website listed in Reference 1. While standard for the US, it has also been adopted in other countries, as well, such as Japan, while many countries in Europe use phase alternation line (PAL). The NTSC format consists of 29.97 (nominally 30) interlaced frames of video a second, each consisting of 480 lines of vertical resolution out of a total of 525 (the rest are used for sync and vertical retrace). Thus, the horizontal scan frequency is 525×29.97 or 15,734 Hz. Each scan line takes approximately 63.5 microseconds. NTSC interlaces its scan lines, drawing odd numbered scan lines in odd numbered fields and even numbered scan lines in even numbered

fields, which gives a nearly flicker-free image at 59.94 Hz (nominally 60 Hz) refresh frequency. This is close to the 60 Hz alternating current power used in the US.

Once we complete the adding of the text to a picture signal, another interesting application for the circuit is subliminal messaging. A subliminal message is one that is displayed for a short time — normally one frame or a 30th of a second, so that it does not register in the conscious mind. Let me say first that I am a skeptic in this area, but a 1973 Federal Communications Commission (FCC) investigation determined that an advertiser had broadcast a subliminal message — “Get It” — in a television commercial, so the FCC proceeded to outlaw subliminal messaging in commercial television.

Enter the LM1881N

The first chip we will use is from the LM1881 family of video sync separators. Costing about \$2.50, the LM1881N is an eight-pin integrated circuit (IC) designed to strip the synchronization information from composite video sources such as NTSC or PAL. An external resistor, R1, allows the LM1881 to be adjusted for source signals with line scan frequencies differing from the 15.734 kHz US broadcast standard.

Four major sync signals are available from the IC when processing the composite video signal (a), shown in Figure 2: composite sync including both horizontal and vertical scan timing information (b), vertical sync pulse (c), color burst pulse (d), and odd/even output (e). The odd/even output level identifies which video field of an interlaced video source is present at the input. The outputs from the LM1881 can be used to gen-lock video camera signals with graphic or text information from a microprocessor. We will only use signals (b) and (c).

Maxim 233

The second chip in our trio is the Maxim 233 dual-channel, RS-232 driver/receiver chip. This chip provides the interface between the zero to five volt world of the microprocessor and the -12 to +12 volt world of the RS-232 personal computer serial interface. While this chip may seem overly expensive at about \$5.00, it has the advantage of not requiring any external components (no electrolytic capacitors to buy), and it runs off of five volts only.

Microprocessor

The third integrated circuit in the project is the Microchip 16F873-16F877 microprocessor running at 20 MHz. At 20 MHz, the microprocessor has an instruction

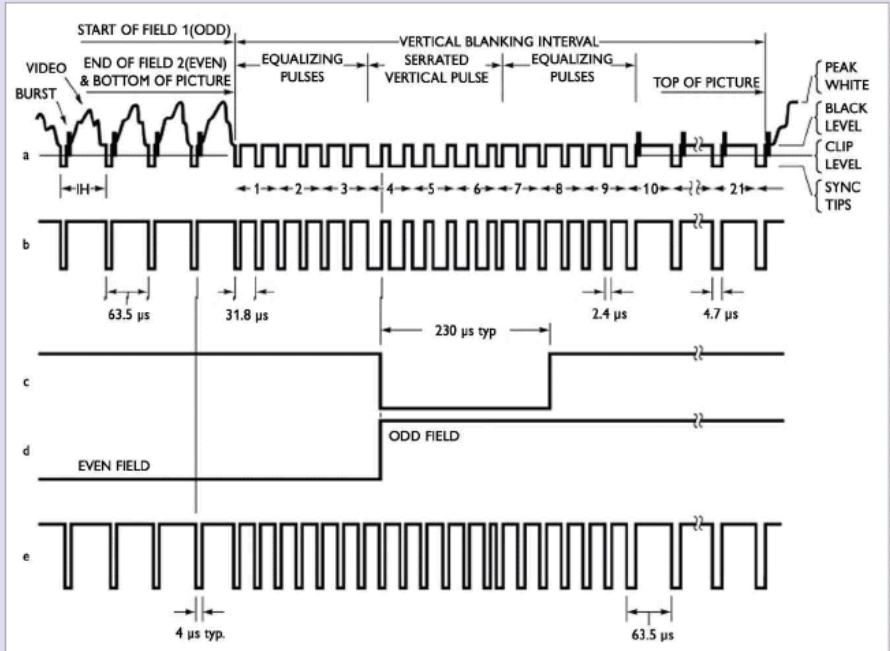
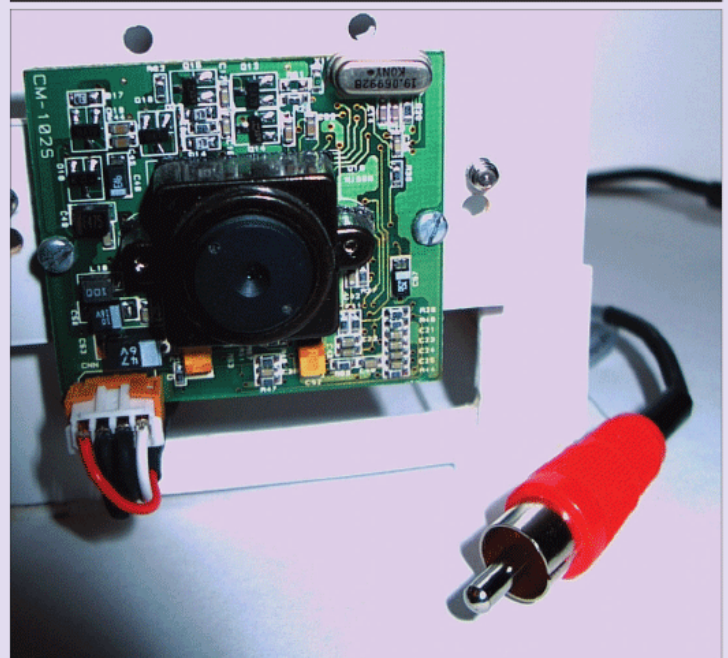

Figure 2. LM1881N waveforms.

cycle time of 200 nanoseconds. The microprocessor is about \$7.00 and has eight kilobytes of reusable programming memory and 368 bytes of data memory.

The programming for the video text display does not take much of the programming memory (772/8192) or the data memory (125/368), so there is plenty of space for adding additional features. Data memory is arranged into two or four banks, depending on whether the microprocessor is a 16F873 or a 16F877. The program is written to only store data in Banks 0 and 1, leaving Banks 2

Figure 3. Video camera for PICVIDEO.



Amazing Devices

www.amazing1.com

Anti Gravity Projects

All new mini 35 kv 1.5 ma adjustable output power supply with instructions on making a simple craft.

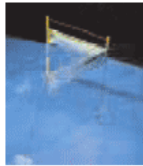

GRA1K Kit \$69.95
GRA10 Assembled \$119.95

Green Lasers Pointers with Colimator



10,000 feet plus - Full 5 mw. A real beauty!!

LAPNGR5 Ready to use...\$129.95

30 Inch Spark Tesla Coil

Light weight table top unit is only 35 lbs with air cooled two point spark gap. For 110 or 220 operation.



BTC4K Kit \$899.95
BTC40 Assmbl'd \$1199.95
BTC3K Kit 10inch spark .. \$349.95

Phaser Pain Field Pistol

Experimental device for animal control. Variable and complex output over 130db. Do not point at people! Higher powered and rental units available.



PPP1K Kit \$59.95
PPP10 Assembled \$84.95

Burning Laser Ray Gun

Uses our sealed CO₂ laser tube and high efficiency current source to generate a continous beam capable of lighting fires over distances. Operates 12 vdc with optional inverter for field or 115vac for lab use.

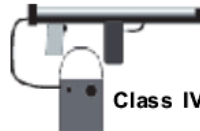

LABURN1 Plans \$20.00
 (all parts available)

Information Unlimited

Box 716, Amherst, NH 03031 USA
 Orders: 1-800-221-1705
 Fax: 1-603-672-5406
 Email: riannini@metro2000.net
 Catalog \$2.00

PIC VIDEO

and 3 for additional data storage.

The video memory that contains the scan line dot patterns for the display is stored in Bank 1; 13 characters x 7 bytes per character = 91 bytes of the 96 bytes of Bank 1's memory are used. Bank 0 contains all other program variables and a total of 34 of the 96 bytes are used. Banks 0 and 1 are used because Bank 0 can be addressed directly with no RPO, RP1 switching, while Bank 1 can be used for indirect addressing with no IRP switching. The coding is written to be

usable on 16F873 through 16F877 microprocessors.

The video timing signals are supplied by the LM1881 chip. Because the video text information must be added to the other video information with great timing precision, interrupts will be used in the microprocessor programming. By using interrupts, we can cause the microprocessor to stop what it is working on, output a scan line of video text information, and then return to what it was doing before. Also, because we want to control the

execution of the instructions very precisely, we will use assembly language.

Building the Hardware

This appeared to be a fairly simple circuit using only three integrated circuits, so I decided to build it on a breadboard. The video feed was from a cheap black and white video camera that cost about \$40.00 and is shown in Figure 3. The PICVIDEO works equally well with a color video camera. Figure 4 shows the final wiring diagram for the project, while Figure 5 shows the completed breadboard ready for testing.

If your television does not have a video input, you will need to purchase an RF modulator and connect it to the TV antenna input. An RF modulator is about \$5.00 and can be purchased from the source in Reference 2. Remember that many video recorders have a built-in RF modulator that generates a TV signal for Channels 3 or 4. A wall wart supplies the 14 volts DC used to run the system. A 7812 voltage regulator supplies 12 volts to

NUMERIC_DATA			ALPHA_DATA		
DEC	HEX	VALUE	DEC	HEX	VALUE
032	020	SP	064	040	@ or °F in PICVIDEO
033	021	!	065	041	A
034	022	"	066	042	B
035	023	#	067	043	C
036	024	\$	068	044	D
037	025	%	069	045	E
038	026	&	070	046	F
039	027	'	071	047	G
040	028	(072	048	H
041	029)	073	049	I
042	02A	*	074	04A	J
043	02B	+	075	04B	K
044	02C	,	076	04C	L
045	02D	-	077	04D	M
046	02E	.	078	04E	N
047	02F	/	079	04F	O
048	030	0	080	050	P
049	031	1	081	051	Q
050	032	2	082	052	R
051	033	3	083	053	S
052	034	4	084	054	T
053	035	5	085	055	U
054	036	6	086	056	V
055	037	7	087	057	W
056	038	8	088	058	X
057	039	9	089	059	Y
058	03A	:	090	05A	Z

Table 1. PICVIDEO ASCII.

the TV camera and the RF modulator, while a 7805 voltage regulator supplies five volts to the integrated circuits.

Jaggies and Jitter

The initial design used a 20 MHz crystal oscillator to drive the microprocessor. One of the problems I ran into was what some people call the jaggies, shown in Figure 6. This was a horizontal back and forth motion of the characters as if they were doing the hula. With cheap black and white TVs and cameras, there is a certain amount of noise in the circuit, but — even with better grade equipment — the hula was still there. I believe this was due to the interrupt latency of the Microchip microprocessors.

The Microchip specification states that, “For external interrupt events, such as the INT (RB0) pin, the interrupt latency will be three or four instruction cycles. The exact

REFERENCES

- 1 www.ntsc-tv.com/ntsc-index-02.htm
- 2 www.jameco.com
- 3 www.phanderson.com
- 4 www2.netdoor.com/~rlang
- 5 www.newark.com

latency depends on when the interrupt event occurs relative to the clock cycle.” This means that there may be a 0.2 microsecond difference in when the data on the screen starts for different scan lines, based on whether the latency for that scan line was three or four instruction cycles. The 0.2 microsecond is the time it takes the microprocessor to output one dot on the screen, which is about the amount of hula action shown in Figure 6.

Figure 4. Schematic diagram for PICVIDEO.

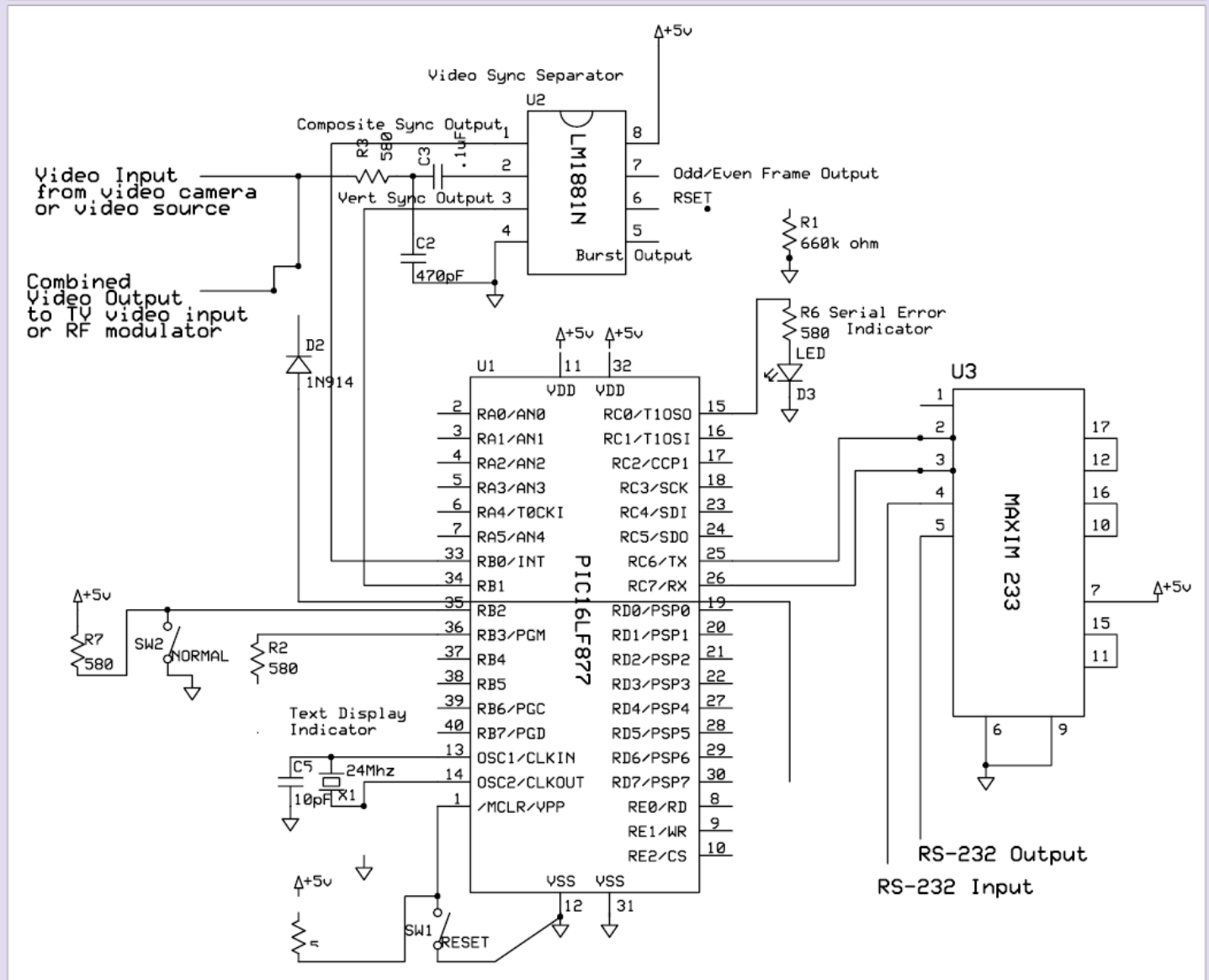

PIC VIDEO

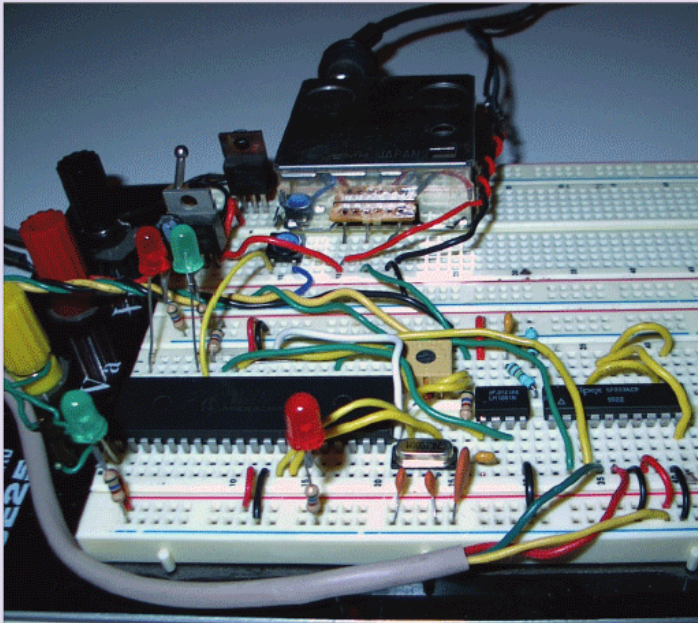

Figure 5. PICVIDEO on breadboard.

ABOUT THE AUTHOR

Robert Lang is a professional electrical engineer interested in embedded microprocessors, MIDI, and music. He has written several articles for electronic hobbyist, computer, and synthesizer magazines. He can be reached at rlang@netdoor.com

Two things were done to try to minimize the hula action. First, the microprocessor was pushed to its maximum clock speed and beyond. I operated the microprocessor at 24 MHz. Second, I doubled the width of the screen characters to minimize the hula. The dot stretching is accomplished by inserting no-operation instruction (NOP) after each dot display is started on the screen. I also tried several variations on a phase locked loop, but these were unsuccessful. One of the pitfalls of using a non-standard clock speed is that the value of SPBRG has to be estimated from the MicroChip equation:

$$\text{Baudrate} = \text{Clockspeed} / (16 * (\text{SPBRG}+1))$$

I came up with the value of SPBRG to equal 77, and BRGH to equal one. This gives an approximate 19200 baud rate on the serial line using a 24 MHz microprocessor clock.

Conclusion

Now, with the hardware built, we are ready to program the microprocessor and test the unit, which we will do next month. While the TV typewriter is functional, more useful applications include superimposing information on the video screen, such as the time or temperature. In "PIC Video, Part 2," we will discuss some possible applications for PICVIDEO and explore the wonderful world of subliminal messaging. **NV**

Part	Description	Source
R1	1/4-watt, 680-Kilohm resistor	Reference 2
C1, C3	0.1-μF capacitor	Reference 2
C2	470-pF capacitor	Reference 2
R2, R3, R5, R6, R7	1/4-watt, 580-Ω resistor	Reference 2
R4	1000-Ω potentiometer	Reference 2
D2	1N914 diode	Reference 2
C4, C5	10-pF capacitor	Reference 2
D1, D3	LED	Reference 2
U1	16F877 microprocessor (preprogrammed)	Reference 3 Reference 4
U2	LMI881N video sync separator	Reference 2
U3	Maxim233 dual RS-232 transmitter/receiver	Reference 2
X1	24 MHz crystal	Reference 5
SW2	SPST switch (NORMAL)	Reference 2
SW1	Momentary contact switch (RESET)	Reference 2
RF1	RF modulator (if your TV does not have a video input and you have no video recorder)	Reference 2
TV1	Video camera	Reference 2

Table 2. PICVIDEO parts list.

Figure 6. Problems with the 20 MHz crystal.

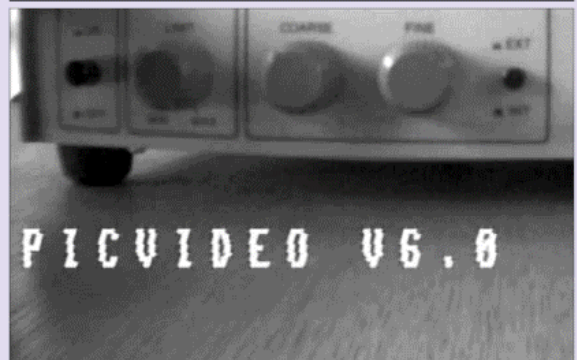

Figure 7. Working PICVIDEO.



ALL ELECTRONICS

C O R P O R A T I O N

QUALITY Parts
FAST Shipping
DISCOUNT Pricing

CALL, WRITE, FAX or E-MAIL
for a FREE 96 page catalog.
Outside the U.S.A. send \$3.00 postage.

COOLERS W/ THERMAL CUT-OFF

New thermoelectric devices, prepped with a temperature cutoff switch. Originally intended for 12Vdc use in picnic and automotive coolers/ heaters. 127 thermocouples per device. $\Delta T_{max}=79\text{degC}$, $T_{hot}=50\text{degC}$, $V_{max}=16.1V$.

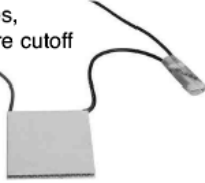

30MM x 30MM x 3.3MM
 $Q_{max}=38.7$ Watts, $I_{max}=3.9A$.
CAT# PJT-5 **\$9⁷⁵** each
10 for \$9.00 each

40MM x 40MM x 3.8MM
 $Q_{max}=56$ Watts, $I_{max}=5.6A$
CAT# PJT-6 **\$12⁷⁵** each
10 for \$11.75 each

40MM x 44MM x 3.3MM
 $Q_{max}=80.6W$, $I_{max}=8.1A$
CAT# PJT-7 **\$14⁷⁵** each
10 for \$13.75 each

LED LIGHT SHOW, 20 BARS



Originally marketed as Christmas lights, these LED covered bars make excellent attention-getting marketing displays or disco-type lighting. In-line pattern generator provides more than 24 different light effects including chasing, burst, wagon wheel, rain fall, progressive and pulsating. Each 11 foot long circuit has 20 bars and cannot be daisy-chained. The green 6.5" long bars each have 8 leds: 2 red, yellow, amber and green (160 LEDs total). Each bar has two mounting holes. Includes 5 Vdc 2 Amp wall power supply.
CAT# LVL-2

Case of 12 for \$4.75 each **\$5⁵⁰** each

12 VDC 1.25A SWITCHING POWER SUPPLY

Phihong
PSA15W-120.
Input: 100-240 Vac, 0.4 Amps. Output: 12 Vdc, 1.25 Amps. 3' cord with right-angle 2.1mm coax power plug, center +. Detachable AC power cord included. UL, CSA, CE.
CAT# PS-1218 **\$11⁸⁵** each



BREADBOARD, 840 CONTACTS

One terminal strip and two power buss strips. Accommodates dip and discrete components. Interconnect with solid hook-up wire (#22 AWG recommended). 2 5/8" x 6 7/8" x 3/8" high.
CAT# PB-840 **\$5⁰⁰** each



SOLAR CELLS w/ CHARGING CIRCUIT - 3 LED'S

Here's a great start for a solar cell project. From not-yet-assembled solar-powered garden lights, these assemblies include two glass photovoltaic cells mounted on a plastic base. Output is approximately 2.6 Vdc @ 25 mA in bright sunlight. Under the photocells is a bracket for a two cell rechargeable AA pack & a small circuit board with three red LEDs. There is a photoresistor on top of the panel between the solar cells to sense light and dark conditions. In daylight the cells charge the battery. When it gets dark, the LEDs light. These are working units but the batteries packs are old and may not take a charge. Our two AA cell nickel-metal-hydride pack, CAT# NMH-2AA (\$2.00 ea.) is a good replacement. Solar cell surface area: 3.78" X 1.98". CAT# SPL-05

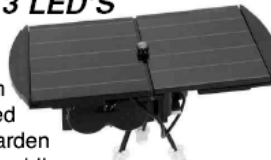

\$4⁵⁰ each
10 for \$4.25 each
100 for \$4.00 each

INVERTER FOR EL PANELS AND STRIPS

Light-Tape™ inverter designed for lighting electroluminescent strips and panels up to 1 square foot. Operates on 12 Vdc or less, depending on surface of panel. 2.35" x 1.08" x 0.68" black plastic enclosure. 18" leads with inline fuse on input. Output requires a 2-pin, 0.1" connector like our CAT# CON-230P (not included).
CAT# INV-9 **\$8⁹⁵** each



AM/FM ANTENNA

Made by Terk for Philips / Magnavox, this great little antenna improves reception and brings in more stations, more clearly than the wire antennas that come with many AM/ FM receivers. Omni-directional. Easy hook-up. Includes impedance matching transformers for 300 Ohm or 75 Ohm. Connects to F-connectors, screw terminals or spring terminals. 5.9" x 5.7" x 1". Gray / blue. Includes instructions. Retail packaged.
CAT# ANT-30 **\$6⁹⁵** each

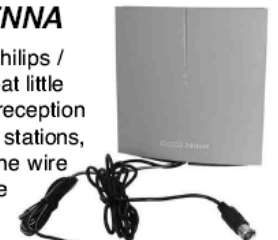

3-6 VDC MINIATURE SPRING-RETURN SOLENOID

Deltrol Controls #56597-60 INT Spring-return, push-pull solenoid. 2 Ohm coil. Operates on 3-6 Vdc. Intermittent duty cycle. Metal-shielded body is 0.91" x 0.42" x 0.45" high. 0.1" diameter plunger extends 0.4" on each side of solenoid. One end of plunger has a 0.11" diameter nylon cap. Four pc pins on 0.75" x 0.2" centers.
CAT# SOL-89 **\$1³⁵** each
100 for \$1.00 each



Shop ON-LINE www.allelectronics.com
ORDER TOLL FREE 1-800-826-5432

MAIL ORDERS TO:
ALL ELECTRONICS CORP.
P.O. BOX 567 · VAN NUYS, CA 91408-0567

FAX (818) 781-2653 · INFO (818) 904-0524
E-MAIL allcorp@allcorp.com

NO MINIMUM ORDER · All Orders Can Be Charged to Visa, Mastercard, American Express or Discover · Checks and Money Orders Accepted by Mail · Orders Delivered in the State of California must include California State Sales Tax · NO C.O.D · Shipping and Handling \$6.00 for the 48 Continental United States - ALL OTHERS including Alaska, Hawaii, P.R. and Canada Must Pay Full Shipping · Quantities Limited · Prices Subject to change without notice.

MANUFACTURERS - We Purchase EXCESS INVENTORIES... Call, Write, E-MAIL or Fax YOUR LIST.

It's Back ...

TETSUJIN 2005

Yes exo-fans, Tetsujin is back for a second action-packed year! Once again, we'll be part of the giant RoboNexus Conference — which will be twice as large as last year. To "suit" the quickly-evolving work in strength augmentation, we've expanded the challenges for Tetsujin 2005. Now you have three ways to showcase your work:

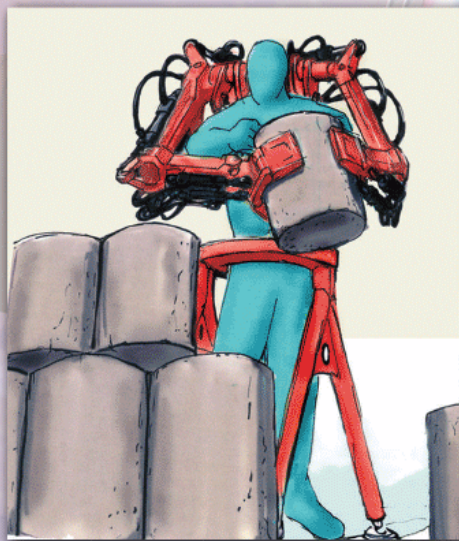

CHALLENGE 1:

Weightlifting. Ascend stairs in your suit to the lifting platform and lift a load of from 100 to 1,000 lbs* from a squatting position to a height of at least 24 inches*, return the load to the ground in a controlled manner, and descend the stairs. Stair-climbing may be unpowered. The winner is the competitor who lifts the most weight.

CHALLENGE 2:

Dexterity. Stack nine concrete cylinders weighing about 70 pounds each in a 4-3-2 vertical arrangement, but don't knock them over as the pyramid grows! The winner is the competitor who arranges the cylinders in the shortest time.

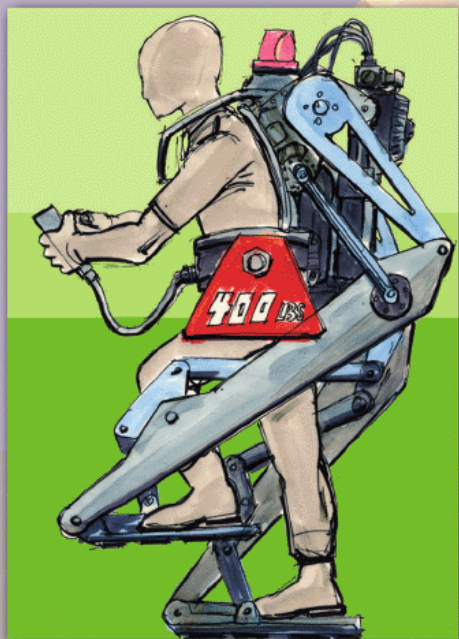

CHALLENGE 3:

Walking Race. Walk the 100 foot* long U-shaped challenge course, stepping over a small obstacle at the half-way point. The shortest time wins, with a time bonus being granted based on any auxillary load carried. Walking must be powered.

The current rule set is available online at

www.servomagazine.com/tetsujin

and questions can be directed to

Tetsujin2005@gmail.com

Start planning **NOW** so you can be a part of the largest "exo-games" event of the year — **TETSUJIN 2005!**

*Specifics of the competition are in a tentative state and may be subject to change.

SCROUNGING FOR PARTS

Safety, Rarity, Quality, Wick, Diversity, and Storage

by Daniel Bartlett

So, you want to fill your hobby electronics drawers with parts galore and don't have the money to start? Well, worry no more, as I am about to teach you how to scrounge for those parts.

To scrounge is to forage about in an effort to acquire something at no cost, and this process can be very easily adapted to electronics as a result of the myriad of broken appliances we find due to the advent of the throw-away society. Computers, televisions, radios, car consoles, you name it — we throw it away. Therefore, electronics hobbyists can have a field day getting many normally expensive parts at little or no cost. However, there are a few “rules” to scrounging, some of which are for your own safety and others that will save you a lot of unnecessary time and effort.

Rule 1: Anything acquired by scrounging is to be considered broken and electrically hazardous.

Never plug into electricity any item that you have scrounged (from whatever source) unless you know exactly what you are doing; better yet, don't do it at all. These items were thrown away for a reason and have the potential to electrocute anyone silly enough to energize them.

Also, take note of the fact that capacitors store charges and have the potential (literally) to give you a belting if you touch them or the circuit. Safe discharge of these devices can be completed through the use of an electrically insulated (1,000-plus-volt) screwdriver or similar tool. Ask a qualified electrician for help in this area if you are unsure. One area that I would never dream of touching, by the way, is the back of a television picture tube. If the stored voltage isn't enough to hurt you, the explosion when you drop it and release a pressure of 2,000-plus-psi surely will.

Rule 2: Only scrounge for rare or expensive parts or something that you know that you will need. There is no point desoldering four-cent, 1/4-watt resistors or standard, small-value, ceramic/monolithic capacitors, for example. You would pay more for solder wick and the electricity to run your soldering iron than

you would for these parts. Instead, look for parts that may seem rare or are known to be more expensive, such as larger capacitors, Schottky diodes, pre-packaged diode bridges, microprocessors (Z80, EEPROM, PIC), relays, and even large switches. These parts can be worth \$3.00-5.00 or more and are worth the time and effort to desolder them.

The least amount of time you can spend on an appliance the better, so you can re-throw it away and get on to the next one. Each appliance provides its own network of components; dwelling for too long on one appliance only creates clutter by hoarding (an unfortunate side effect of scrounging). Actually, one of the best ways to find out the value of any particular part is to have an electronics component catalog handy, whether from the manufacturer or a retail establishment (Dick Smith Electronics, RadioShack, or similar). Although many of these companies only sell common parts, the expensive ones can quite easily be identified.

Rule 3: Look for obvious signs of deterioration on any particular part. If a capacitor has burst and leaked all over the board, there is no point in scrounging it, as it will not work anyway. Other obvious signs of deterioration include burning/overheating (characterized by blackened areas and *that* smell), chemical damage (caused by leaking capacitors, batteries, or external fluids), water damage (obvious in itself), and physical breakage (if the appliance has been dropped, the board may have cracked in half, taking many components with it).

Much of this rule is simply common sense; if the component looks broken, it probably is. However, if you are unsure, there are measurement devices that you can build or purchase that will give you a better indication of the condition of a particular component. These devices include multimeters (especially those with a diode test function), transistor testers, capacitance leakage detectors, and others. Sometimes a part may look perfectly fine, but may, in fact, be faulty (for example, a transistor going open circuit). Measurement devices can help you in this regard, but

SCROUNGING FOR PARTS

only use them after following Rule 2; it has to be worth the trouble.

Rule 4: Invest in a roll of solder wick. Solder wick is a roll of braided material which “accepts” solder that is removed from a printed circuit board (PCB). I use the type made by Hakko® (www.hakko.com), manufacturers of solder wick in a range of thicknesses, from 0.6 to three mm. Solder wick effectively cleans solder away from the joint, therefore making the component in question much easier to remove. Because the heat is transferred to the wick itself, there is less of a chance of damaging a good part.

While on the topic of desoldering, you should remember that there are also a few rules when choosing a soldering iron, as the cheapest iron will often mean the destruction of many functioning parts. A cheaper soldering iron (of the \$10.00 to \$20.00, 25-watt variety, for example) will often have a tip much too big for delicate electronics work and, on the other side of the coin, have too little power to be used to solder large battery lugs and such. My advice is to spend a little more money on a soldering iron (even a soldering station), as a one-time \$150.00 investment is much better than 20 \$20.00 investments, especially over a number of years. I have experi-

enced cheap solder tips degrading from heat only days after they have been purchased and it really isn't worth the trouble.

Rule 5: Remember that “parts” aren't the only things that can be scrounged from an appliance.

Electrical appliances can be recycled in many ways. They have cases, knobs, dials, rubber feet, gauges, plugs, sockets, leads — you name it. These items are often much easier to remove, as they usually only involve the use of a screwdriver. These accessories can be used to repair other items of the same type or may even provide housings and personalization for projects of your own. Remember that cases do take up a lot of space, so be choosy and keep only what you think you'll need. Rubber feet, knobs, and screws can be stored quite easily, as long as they are still in good condition (not destroyed by sun damage, for example), so take them out and keep them for a later date.

For those who have not delved into the world of scrounging before, try removing the smaller accessories first. Better yet, try removing them and putting the appliance back together again, as it is often a completely different experience altogether. If you can take something apart and successfully put it back together again, you may have

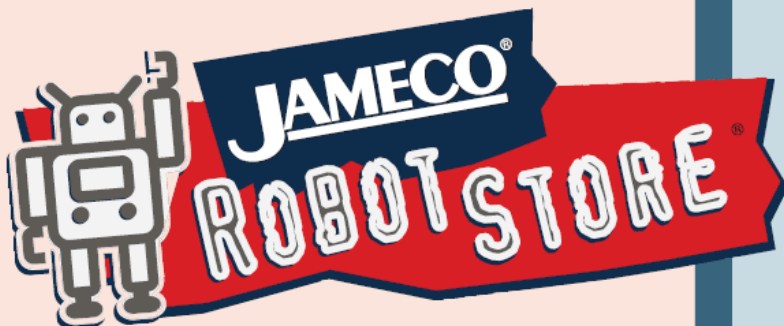

Robotic Arm Kit
(No. 4-523)

**We're
Back!**



Twin Motor Gearbox Kit
(No. 3-709)

Yes! The internet's first and best robotics source has been purchased by Jameco Electronics, and we're committed to greatly expanding the product line quickly!

Each month we'll add hundreds more new robotics products. Plus we'll continue to supply favorites like Muscle Wire®, the OctoBot Survivor™ robot and more.

Be sure to visit us online at

www.RobotStore.com

or call

1.800.374.5764

...and see what's changed!

For All Your Robotic Needs!

reached the level of care needed to refrain from destroying delicate electronic components.

Rule 6: Store scrounged parts so that they can be found again.

There is no use spending an hour or so unscrewing and desoldering parts and accessories from PCBs and the like if you can't find them when you need them. To explain this further, if you put all of your parts into a big cardboard box, along with a mass of wires, you are wasting your time. Ensure that parts are stored in labeled containers (preferably stackable parts drawers, available quite inexpensively from hardware stores), so that they can be found with a quick glance. You can store them along with your purchased parts, of course, so label drawers with names like "resistors," "diodes," "relays," and the like.

I consider this process follow-up. You get to know where your parts are, so you can find them in a matter of seconds, rather than a matter of terse hours. Also, storing parts in a neat and clean fashion has advantages other than easy recollection; it makes your garage or workshop look a lot neater, while keeping the "other half" happy.

I hope that you will take these few simple rules into mind next time you drag home for stripping your next dump-found broken appliance. They will make your life so much easier, I assure you, and you will save a lot of money. It may be easier to remember the quick version of the rules: safety, rarity, quality, wick, diversity, and storage.

Scrounging is a hobby in itself, but you should scrounge only for what you'll really use. Please keep in mind that safety always comes first. Nothing is so important that you should take unnecessary risks. If you have any further questions or comments on this article, feel free to email me at justfordantheman@telstra.com I will usually reply within a day or two, if I'm not busy scrounging! **NV**

**Builders - Installers - Creators - We have something for you.
A little bit of everything and more**

Surplus and Unique Items • Serial ASCII Displays

 2x40 Fluorescent Display Module. iTron CU40026SCP-B-T20A 9.5" x 1.75" x 1" . . . \$15.00

 MDLS40466-LV-LED04. • 8.25" x 2.25" x .5" 40x4 LCD with LED backlight \$15.00

Security / Surveillance Equipment

Panasonic 1/3" CCD Color Camera. 120V 60Hz. wv-CP240 with 4.5mm 1:12 lens • 480 lines of horizontal resolution. 1.0 V[p-p] NTSC composite 75 Ω/ BNC connector . \$59.00





Panasonic CCD Camera with 4.5mm Lens



Panasonic AG-RT850 time-lapse VCR. The Jog/Shuttle dial makes scene searches quick and accurate. The built-in RSV-232C interface allows direct control of the AG-RT850 from your PC with user-provided software. Records up to 240 hours. \$179.00

240 Hour VCR

 View Sonic OEM power adapter for LCD monitor. #HASU05F 100-240V AC input, auto switching. 12V DC @ 4.58A output. Barrel type DC connector. PSO079 \$19.00

 View Sonic OEM power adapter for LCD monitor. # HASU05K 100-240V AC input, auto switching. 19V DC @ 3.16A output. Barrel type DC connector. PSO080 \$19.00

 View Sonic OEM power adapter for LCD monitor. # PSCV700101A 100V AC input, 12V DC @ 5.8A output. Barrel type DC connector. Mfg.. by Samsung. PSO083 \$19.00

Motors with gear boxes • Power Supplies



Escap 22C DC Gearhead Motor with 190:1 Reduction (R22) \$25.00



110V Molon AC Motor With Electro-Magnetic Brake - high torque heavy duty motor with 4.75" Dia.. disc attached. 3/16th Dia.. O-Ring 'tire'. Great for automation projects. The disc is snap-ring installed and can be removed easily. Molon HGM-4050-29 or similar models \$3.00



4.75" Dia.. disc attached with 3/16" Dia.. Rubber O-Ring. Motor is 1 1/8" Dia.. Motor and gear housing are 2 1/2" tall, gear housing is 2.75" x 3" x 5/8". Motor is labeled RSV-380SH - RN545Y16 - China These are strong enough for use in drills and screwdrivers. Operating range is between 3 and 9 VDC with 7.2VDC being optimal for an unloaded RPM of 16,200 and loaded of 14,000. \$4.00

<http://www.computercci.com>



**Sales: 760-724-2404
Fax: 760-724-8808**

THE SOLAR ALTERNATIVE

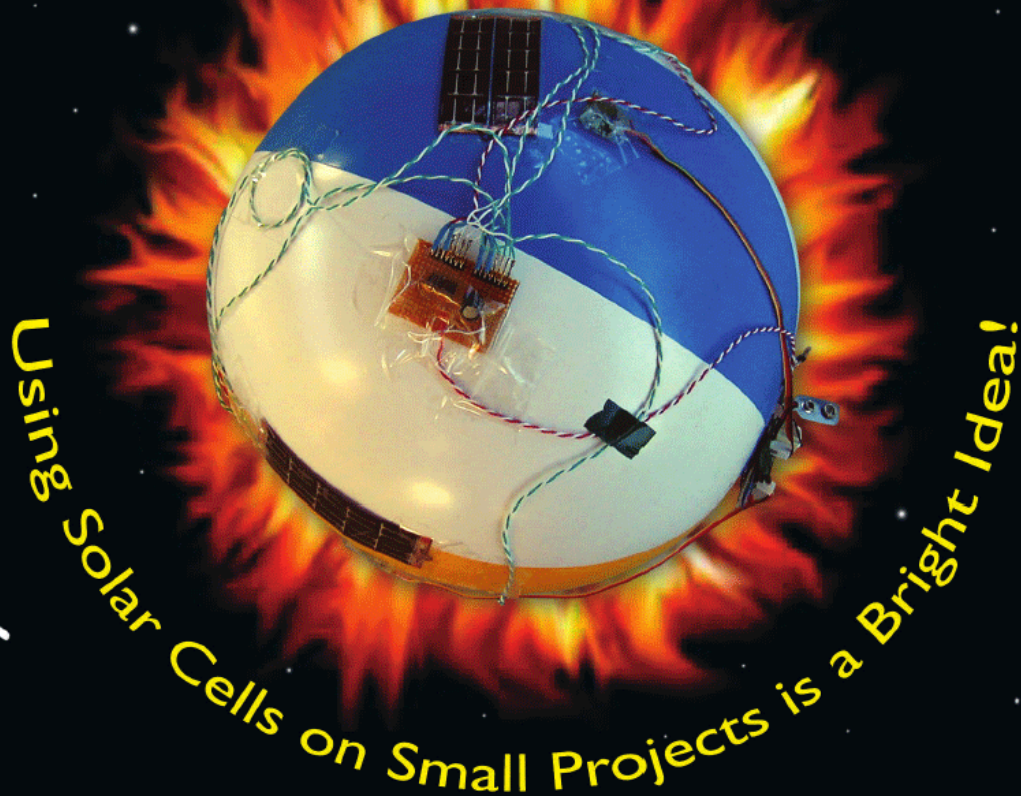

Using Solar Cells on Small Projects is a Bright Idea!

by Ralph Lorenz

Efforts to design and construct devices for supplying renewable energy surprisingly began nearly 150 years ago, ironically, at the very height of the Industrial Revolution, which was largely founded on the promise of seemingly inexhaustible supplies of fossil fuels. Contrary to the prevailing opinion of the day, a number of engineers questioned the practice of an industrial economy based on nonrenewable energy and worried about what the world's nations would do after exhausting the fuel supply.

THE SOLAR ALTERNATIVE

The earliest known record of the direct conversion of solar radiation into mechanical power belongs to Auguste Mouchout, a mathematics instructor at the Lyce de Tours. Mouchout began his solar work in 1860 after expressing concerns about his country's dependence on coal. "It would be prudent and wise not to fall asleep regarding this quasi-security," he wrote. "Eventually industry will no longer find ... the resources to satisfy its prodigious expansion. What will industry do then?" By the following year, he was granted the first patent for a motor running on solar power and continued to improve his design until about 1880. During this period the inventor laid the foundation for our modern understanding of converting solar radiation into other forms of power.

Where Mouchout left off, a French man by the name of Charles Tellier took over in 1885. Considered by many the father of refrigeration, Tellier actually began his work in refrigeration as a result of his solar experimentation, which led to the design of the first nonconcentrating, or non-reflecting, solar motor.

If you're concerned about your ever-growing battery bill, you might want to consider using solar power. Although solar cells are not usually as straightforward as batteries, once you get used to their characteristics, they're easy.

Types of Solar Cells

A solar cell (sometimes called a photovoltaic cell) is basically a large diode. Just as a photodiode (or even, for that matter, a regular glass-walled diode like a 1N914) will produce a voltage when exposed to light, so will a solar cell. The difference is that a solar cell is designed to produce a useful current. Most solar cells, like most diodes, are made from silicon. A few other semiconductors can be used, such as gallium arsenide, but these are found only in very special circumstances, such as satellites that might need to endure large amounts of radiation in space that would damage silicon cells. Copper oxides can be made to act as solar cells, too (and were the first type of cell discovered), but they are very inefficient.

There are basically two types of silicon cells — crystalline and amorphous. Crystalline cells are made from thin wafers of nearly pure silicon, just like those used to make silicon chips (for that reason, they are often circular or curved, having been cut from circular wafers). They are rigid, but light and fragile, and are fairly expensive to make. Rather cheaper are amorphous cells, which are made from silicon deposited onto a substrate. This can be glass, as in the Sunceram cells by Panasonic that are used in many small solar robot projects, or a flexible plastic film, such as the

SCHEMATIC & PCB LAYOUT SOFTWARE

as low as **\$99**

CircuitCREATOR

Windows 95/98/NT/2000/XP Compatible

Schematic Capture, PCB Layout, Automatic Router
Gerber Creator / Viewer & Spice Simulator

Up to 32 E-size sheets, 256 Layers

Over 25,000+ parts / symbols / Footprint

User expandable Library

Up to 50 different pad shapes and sizes.

Export to 15 different CAE programs.

Routes multi-layer boards, 2 layers at a time,
with different line widths.

Full interactive graphical symbol & part editor included.

FREE DEMO DOWNLOAD

www.advancedmsinc.com

ams Advanced Microcomputer
Systems Inc.

Tel: (954) 784-0900 Fax: (954) 784-0904

info@advancedmsinc.com

1-800-319-3599

APRIL 2005

Circle #72 on the Reader Service Card.

ATTENTION! ELECTRONICS TECHNICIANS

EARN YOUR
**B.S.E.E.
DEGREE**

THROUGH HOME STUDY

Our Highly Effective Advanced-Placement Program for experienced Electronic Technicians grants credit for previous Schooling and Professional Experience, and can greatly reduce the time required to complete the program and reach graduation. No residence schooling required for qualified Electronic Technicians. Through our Special Program you can pull all of the loose ends of your electronics background together and earn your B.S.E.E. Degree. Upgrade your status and pay to the engineering level. Advance rapidly! Many finish in 12 months or less! Students and graduates in all 50 states and throughout the world! Established Over 50 Years! Write or call for free Descriptive Literature. (601) 371-1351



**COOK'S INSTITUTE
OF ELECTRONICS ENGINEERING**

4251 CYPRESS DRIVE, JACKSON, MISSISSIPPI 39212
• FAX: (601) 371-2619

Visit us TODAY on the World Wide Web at <http://www.cooks.edu>

Circle #87 on the Reader Service Card.

THE SOLAR ALTERNATIVE

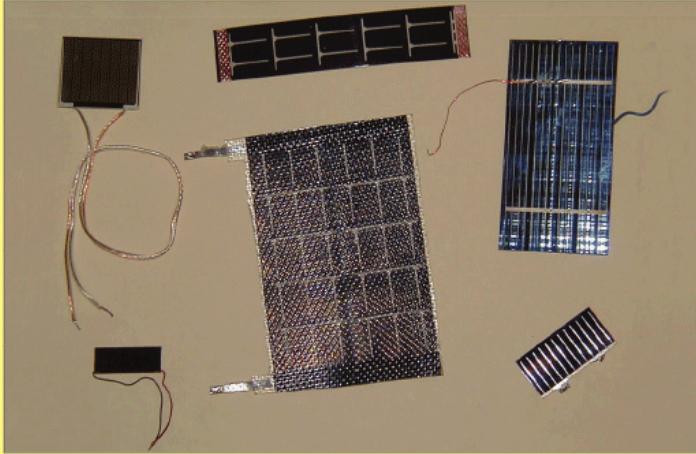

Clockwise from top left are various types of solar cells: a Sunceram five-volt cell from Solarbotics, a TX 3-25 thin film plastic Powerfilm three-volt module from Iowa Thin Films, a large crystalline silicon cell (0.6 volt) from a grab bag, a smaller silicon cell (0.6 volt), a larger three-volt Powerfilm module — this one encapsulated in an ultraviolet-resistant Tefzel sheet, and a small Sunceram module taken from a defunct calculator.

Powerfilm cells by Iowa Solar Films. These thin plastic cells can be very lightweight and can be bent around various shapes. For outdoor applications, these are available in an ultraviolet resistant Tefzel plastic coating, though this makes the cells heavier and more expensive.

Because a cell is just a diode, it produces a voltage that is nearly a constant, related to the electronic bandgap of the material. For silicon, this is about 0.6 volts. This is obviously inconveniently low, so it is usual to array cells in series (a “string” of cells) to yield a useful voltage. One way is, of course, to solder or clip together lots of individual cells, but this can be tedious and delicate. Many modern amorphous

Solar cell output characteristic (I/V curve). The blue line is the output of two Powerfilm TX 3-25 modules in series.

The short-circuit current is about 37 mA and the open circuit voltage about 7.5 volts. Peak power of about 0.15 watts (red line) occurs for an output of about five volts and 25 mA. Operation at three or 6.5 volts will reduce the output to about 0.1 watts (green line). Peak-power conditions correspond to a load impedance of about 200 ohms.

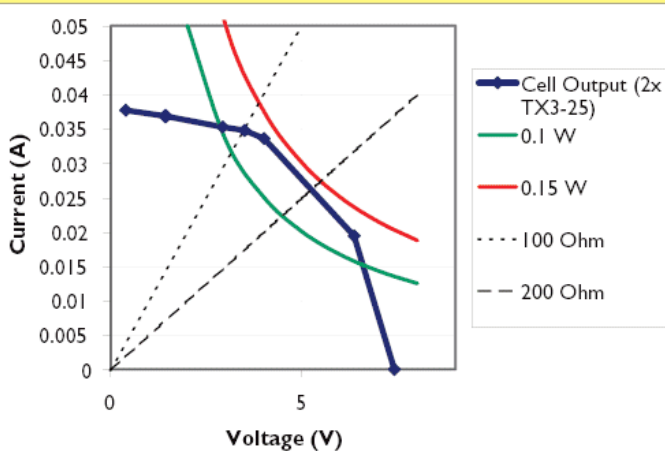

cells, where the silicon is painted onto a substrate, are basically painted on as several individual cells connected in a series, making a much more convenient solution. Such mini-arrays are available with outputs from three to 15 volts.

Peak-Power Tracking

A solar cell's output characteristic (the I/V curve) for given light conditions is usually fixed by two numbers: the open-circuit voltage and the short-circuit current. These are what you read if you just put a high-impedance voltmeter across the cell or a low-impedance ammeter, respectively. The open-circuit voltage for individual silicon cells is always about 0.6 volts. It depends only very slightly on light levels, but will depend on temperature being a little higher under cold conditions. (Solar cells on satellites also need to worry about the characteristic being affected by radiation in space, but, unless you are unhealthily close to a nuclear reactor, you shouldn't need to worry about this.)

The short-circuit current is directly proportional to the light level and is basically set by the area of the cell. (More area means more photons of light collected, and more photons mean more charge carriers and more current.)

However, neither of these test conditions is useful. The power provided by the cell is voltage x current, so the short- and open-circuit tests give no power.

Domestic power plants and satellite power systems use feedback control circuits to track this peak-power point (which depends on temperature, light levels, radiation dose, and so on). However, for simple robots and other projects, it is usually adequate to assume that peak power will be roughly three-quarters of the open-circuit output and design the circuit to operate fixed at that point. Still, before finalizing a circuit, it's a good idea to measure the output characteristic of the cells you're using by putting different load resistors across it and measuring the voltage. The output power is just the load resistance multiplied by the square of the voltage across it.

One useful IC for small solar power supplies is the ICL7660 voltage converter, which rapidly charges a capacitor with the supply, then switches over to charge another, and then back to the first before it has time to substantially discharge. These two capacitors are wired so that their voltages can be summed together to give almost double the input. The device can handle input voltages from 1.5 to 10 volts. Maxim makes higher current versions; the MAX 860 and 660 are able to handle up to around 100 mA.

Light Levels

Sunlight at noon on a clear day dumps about 1,300 watts of power per square meter. A 10-cm² cell, therefore, intercepts about 13 watts of sunlight, but only a fraction of this can be converted into electricity. Even the most efficient (and expensive) multiple-junction cells on satellites convert only about 20 percent of this into power. For the amorphous

THE SOLAR ALTERNATIVE

cells in most small electronics applications, the efficiency is only about five percent. The crystalline silicon cells used for most domestic power systems are typically about 10 percent efficient, so we can only get about one watt out of a 10 x 10-cm² cell.

Note, however, that we will have much less power available in dim, indoor conditions. Our eyes are very adaptable, so we can see over a wide range of light levels (full moonlight has a million times less light per unit area than full sunlight), but a solar cell's short-circuit current (and therefore power at peak-power conditions) will be proportional to the light intensity. Consider the floor of a six-meter-wide room lit by a 100-watt light bulb. Even if the walls and ceiling were perfect mirrors, a robot on the floor is only going to receive about three watts per square meter. A 10 x 10-cm cell and five percent conversion efficiency would only produce about 1.5 milliwatts of electricity.

Devices for indoor operation and devices with very small solar cells must, therefore, either have microwatt power levels (calculators are one example) or must trickle-charge an energy store and operate only periodically. This is the "solar engine" circuit used in many BEAM projects: A capacitor is trickle-charged, essentially starting out by charging with the high short-circuit current from the cell, then trailing off as the capacitor charges up. Eventually, it will almost reach the open-circuit voltage of the cell, only drawing enough current from the cell to balance any leakage. However, a threshold switching circuit, using a flashing LED or a 138 voltage switch, will instead discharge the capacitor when the voltage has reached a useable level.

An Example — Solar Power With Current Monitoring

One project I have recently begun is a Tumbleweed rover, a windblown sphere that can traverse a long distance by rolling in the wind without using motors to drive it. Such a vehicle

has been proposed for exploring Mars and one was recently tested in Antarctica. I wanted to explore how a lightweight, solar-powered version could be made by attaching flexible solar cells to the wall of a beachball, using a Basic X-24 microcontroller to measure its motion with an accelerometer (see the Frisbee Black Box project in the February 2004 *Nuts & Volts*).

Because a solar-power-only rover could have its power interrupted by shadows, I used a small battery for short-term operation, which would then be topped off by the solar panels. Driving the microcontroller required 25 mA or so at six volts or more, so I used a set of three tiny nickel metal hydride (NiMH) batteries, each with two cells. These were so small that they could be

The Power to Design...

PICs AVR KITS
CPLDs PC I/O

Development Tools & Kits

Kits for most micros, CPLDs, and more starting at \$15...

- Universal CPU Board
- PIC and AVR Kits
- Programmable Logic Kits
- SeaBass Basic Compiler (as low as \$10!)
- TTL RS232 Adapters
- PC I/O for Basic, C, Java, Linux, and More

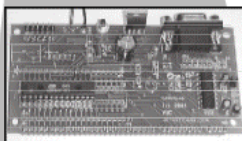

C Programmable AVR Kit
\$39.95

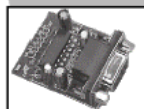

RS232 Adapter
Sale! \$13.95



Serial PWM
\$24.95

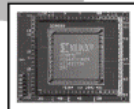

Xilinx CPLD Kit
Starts at \$49.95

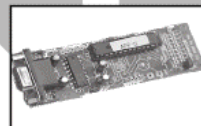

PIC Programming Kit
Starts at \$29.95

PAK Coprocessors

Add powerful features to any microcontroller project. Perfect for use with Basic Stamps! Starting at under \$10...

- Floating Point & A/D
- PWM & Pulse Output
- Servo Control
- Pulse Input
- PS/2 Keyboard or Mouse

Visit us for free tools, tutorials and projects

www.awce.com/nv

Circle #98 on the Reader Service Card.

WANTED: DEALERS AND IMPORTERS

For EUROPE's No.1 (Educational) Electronic KITS

SAM-01 KIT

Serial I/O controller
For House Automation

Can also be used to control MOVIT/OVI
Robot Arm trainer by your computer.



FUN KITS
Piano
&
Stress Meter



Educational
SOLAR
KITS

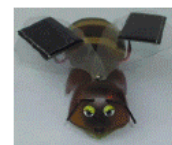

WWW.AREXX.COM

Please contact us by e-mail: info@arexx.nl

THE SOLAR ALTERNATIVE

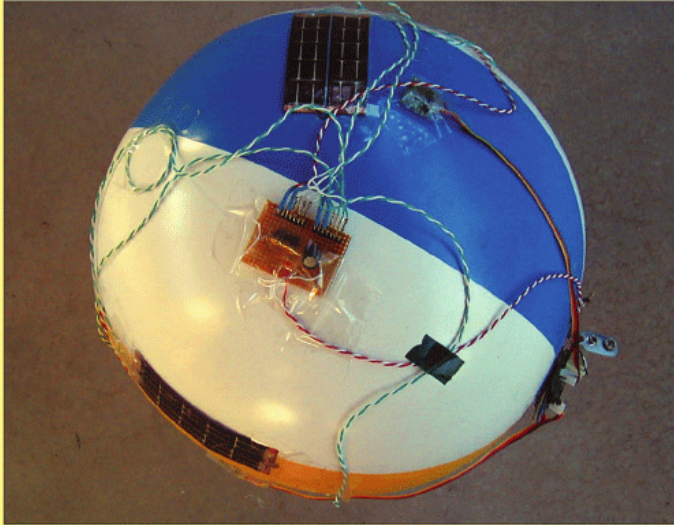

A Tumbleweed rover made from a beachball and thin-film solar cells (top and bottom) with a circuit board carrying diodes, etc. in the center. Another small board with a microcontroller is at right. By distributing the components around the ball, it rolls more evenly.

distributed around the perimeter of the beachball. Pin 24 (Vin) of the BX-24 was connected to the batteries (Vout) via a switch. You might get away with a smaller battery, wiring four cells to get 4.8 volts to the Vss supply on the BX-24, but this would be much less tolerant of voltage drops as the battery discharged. Also, if you don't need the speed, memory, or A/D converters of the BX-24, you could use a BASIC Stamp 2 or, of course, a PIC microcontroller.

I wanted to monitor the battery voltage using the BX-24 as a data logger, but its analog-to-digital converter inputs need zero to five volts. Because of this, the two 100K resistors are set up as a potential divider to take the seven or eight volts of the battery down to this range (Vout/2 Monitor).

Now, I wanted to also monitor the current coming from each of the solar arrays, since the power from each would come up and fall off as the Tumbleweed rolled around. Each of the arrays was a series string of four TX 3-25 thin-film modules, giving an open-circuit voltage of about 15 volts total, but a peak-power operating voltage of more like 10 volts.

D1 and D2 are blocking diodes to stop the battery from

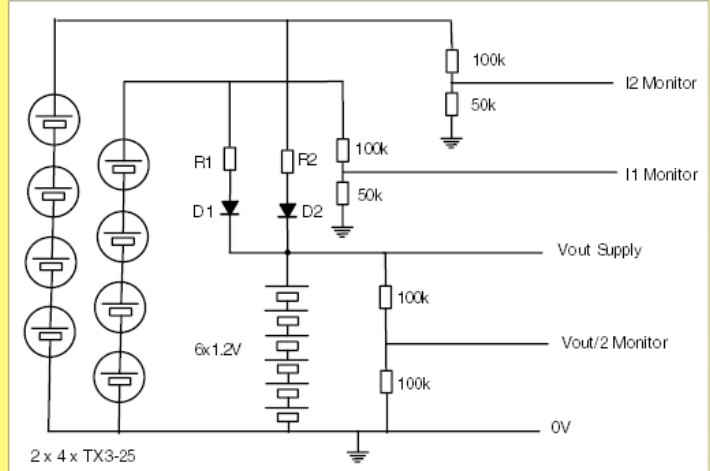

Circuit for the Tumbleweed power supply. This circuit charges a battery when it can, and provides for monitoring the battery voltage and charging currents. You can remove the bits of the circuit you don't need or clone the solar array and charging monitor parts if you have more arrays. If you have more than one array or even only one array and a battery, though, you need a blocking diode for each.

discharging backward through the solar panels, which would not only waste battery energy, but also could damage the cells. An ordinary silicon diode will do, but it can be wasteful (especially in low voltage designs), since there is a drop of some 0.7 volts or so across it. I prefer to use a germanium diode, since the voltage drop here is only 0.3 volts or so.

If the cells are not illuminated (or only weakly so), the diode does not conduct and the current monitor output (I1, I2 monitor – this time divided by three to get into the zero-to five-volts A/D range) will be low. If, on the other hand, it is strongly illuminated, the voltage will be enough to cause a current to flow into the battery via the diode and the relevant resistor R1 or R2. This resistor allows the current to be sensed – a value of 100 ohms is about right. Imagine the array is putting out 20 mA, then the voltage here must be equal to the battery voltage plus the 0.3-volt diode drop and plus R1 times the current, or $0.025 \times 100 = 2.5$ volts. From the simultaneous measurement of the battery voltage and this monitor, the charging current can be figured out. If you don't need to sense the charging current, you don't need a resistor here, and the circuit will be more efficient without it.

SOURCES

SOLARBOTICS (www.solarbotics.com) has a range of amorphous Sunceram cells for small robot projects such as solar engines.

EDMUND SCIENTIFIC (www.scientificsonline.com) has a range of solar cells, multi-cell panels, low-current motors, and various experiment kits.

The Iowa Thin Film cells are available from **JAMECO** (www.jameco.com) and are from three to 12 volts with a range of currents and plastic coatings.

When to Use Solar Cells

The most obvious applications for solar power are outdoor devices with modest power needs of a fraction of a watt. Very low power applications and indoor systems can be driven much more easily with an alkaline battery (although note that a solar cell circuit might be lighter). For powers of a few watts or more, solar power can be rather expensive. On the other hand, solar driven devices can be aesthetically pleasing and, for lawn lights or weather stations or other applications where it is convenient not to have to replace batteries, solar power can be a bright idea. **NV**

CALL TOLL-FREE

(800) 292-7711
Orders Only

Se Habla Español

C&S SALES

Secure On-line Ordering @ cs-sales.com
FREE GIFT with online purchase (use coupon code NV)

CALL OR WRITE
FOR OUR
FREE

64 PAGE CATALOG!
(800) 445-3201

Elenco Digital Multimeters

Model M-1750



\$24.95
11 Functions:
• Freq. to 20MHz
• Cap. to 20µF
• AC/DC Voltage
• AC/DC Current
• Beeper
• Diode Test
• Transistor Test
• Meets UL-1244 safety specs.

Model LCM-1950



\$59.95
• Large 1" 3 3/4 Digit LCD
• Autoranging Freq. to 4MHz
• Cap. to 400µF
• Inductance to 40H
• Res. to 4,000Ω
• Logic Test
• Diode & Transistor Test
• Audible Continuity Test

Model M-2795



\$44.95
• AC/DC voltage
• Current (10A max)
• Beeper
• Frequency to 15MHz
• Capacitance to 200µF
• Transistor test
• Diode test
• Logic test
• Data hold
• Free holder

Quantity Discounts Available

Elenco Snap Circuits™

Elenco's new Snap Circuits™ make learning electronics fun and easy. Just follow the colorful pictures in our manual and build exciting projects, such as: FM radios, digital voice recorders, AM radios, burglar alarms, doorbells, and much more! You can even play electronic games with your friends. All parts are mounted on plastic modules and snap together with ease. Enjoy hours of educational fun while learning about electronics. No tools required. Uses "AA" batteries.

6 versions available.
Build up to **750** projects!
As low as **\$29.95**

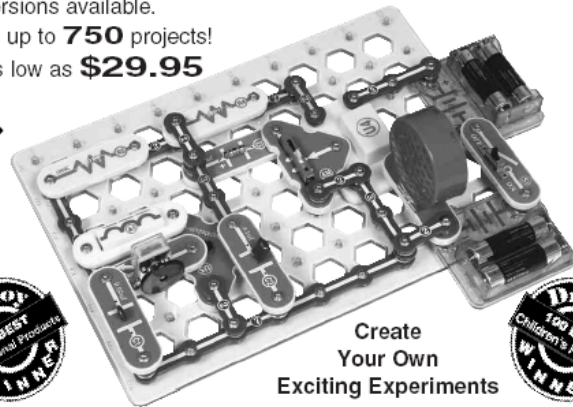

Create Your Own Exciting Experiments



Test Equipment



Elenco Handheld Frequency Counters 10Hz - 3GHz Models F-2800 & F-2850

- 10 digit display
- 16-segment RSSI bargraph
- Resolution to 0.1Hz (F-2850)
- Resolution to 1Hz (F-2800)
- Selectable gate time (F-2850)
- Hi-speed (300MHz) direct count
- Includes NiCd charger and antenna

F-2800.....\$99
F-2850.....\$185

Elenco Quad Power Supply Model XP-581

4 Fully Regulated Power Supplies in 1 Unit



\$75

4 DC Voltages: 3 fixed; +5V @ 3A, +12V @ 1A, 1 variable; 2.5 - 20V @ 2A • Fully regulated & short protected • Voltage & current meters • All metal case

Elenco Oscilloscopes

Free Dust Cover and x1, x2 Probes



2 year warranty
S-1300 25MHz Delayed Sweep \$439
S-1340 40MHz Dual Trace \$475
S-1345 40MHz Delayed Sweep \$569
S-1380 60MHz Delayed Sweep \$725
S-1390 100MHz Delayed Sweep \$895

Elenco RF Tracer 1MHz - 3GHz Model F-2700



\$195
• Pocket-size, easy-to-use
• Speaker/earphone/vibrate alerts
• 5-segment RSSI bargraph
• Low power consumption
• Includes NiCd, charger, and antenna
• Tells you if your room is bugged.

Elenco 5MHz Sweep Function Generator w/ built-in 60MHz Frequency Counter Model GF-8056



\$225
Generates square, triangle, and sine waveforms, and TTL, CMOS pulse.
GF-8048 - 3MHz w/ counter \$199
GF-8025 - without counter \$99.95

iBOTZ Hydrazoid Kit Model MR-1004



Walks and makes sounds

\$29.95

non-soldering

Models Available

SC-750 - Extreme Version, contains over 80 parts to build over 750 experiments. Includes everything from SC-500 plus experiments in solar, electromagnetism, vibration switches, and 70 computer interfaced experiments.....	\$119.95
SC-500 - Pro Version, contains over 75 parts including voice recording IC, FM radio module, analog meter, transformer, relay, and 7-segment LED display. Build over 500 experiments.....	\$89.95
SC-300S - Deluxe Version, contains over 60 parts. Build over 300 experiments plus 20 bonus computer interfaced experiments.....	\$74.95
SC-300 - Standard Version, same as SC-300S, but without bonus experiments.....	\$59.95
SC-100 - Snap Circuits, Jr., contains over 30 parts. Build over 100 experiments.....	\$29.95

Elenco Educational Kits

Model 21-880 Line Tracking Mouse Kit \$25.95 Sound Activated Solenoid Required	Model AM-780K Two IC Radio Kit \$9.95	Model AK-700 Fuse-Tone Telephone Kit Flashing Neon Lights Great School Project \$14.95
Model RCC-7K Radio Control Car Kit \$27.95 • 7 Functions • Transistor Inc. AK-870 (non solder) \$27.95	Model M-1006K DMM Kit \$18.95 • 18 Ranges • 3 1/2 Digit LCD • Transistor Test • Diode Test	Model K4001 7W Amplifier \$12.95 K2637 - 2.5W Audio Amplifier - \$10.50

Deluxe Soldering Irons

Elenco 4-Functions-in-1 Instrument Model MX-9300B

\$495

Ideal for labs, production lines, R&D and hobbyists!

Sweep Function Generator

- 0.2Hz to 2MHz
- Sine, square, triangle, skewed sine, ramp, pulse, TTL level square
- VCF voltage 0 to 10VDC

Digital Triple Power Supply

- Output #1: 0-30VDC, up to 2A
- Output #2: 5VDC, up to 2A
- Output #3: 15VDC, up to 1A



Digital Multimeter
• 400mV - 400V AC/DC
• 20A max. AC/DC current
• Resistance to 40MΩ

Frequency Counter

- 1Hz to 2.7GHz
- 7-digit display
- Selectable time base

Weller® Low Cost Soldering Iron Model WLC100



\$34.95

- Variable power control produces 5-40 watts.
- Ideal for hobbyists, DIYers and students.
- Complete with 40W iron.

Electronic Science Lab

Maxitronix 500-in-1 Electronic Project Lab Model MX-909

Everything you need to build 500 exciting projects!

- Learn the basics of electronics. 500 different electronic experiments, special lighting effects, radio transmitter and receivers, sound effects, cool games and MORE!
- Includes built-in breadboard and an LCD.
- Explore amplifiers, analog and digital circuits plus how to read schematic diagrams.
- Includes 11 parts.
- Lab-style manual included.
- Requires 6 "AA" batteries.



MX-908 - 300-in-1 Lab \$69.95
MX-907 - 200-in-1 Lab \$49.95
MX-906 - 130-in-1 Lab \$39.95
EP-50 - 50-in-1 Lab \$18.95

\$175

Guaranteed Lowest Prices

UPS SHIPPING: 48 STATES 7% (Minimum \$7.00)
OTHERS CALL FOR DETAILS
IL Residents add 8.5% Sales Tax

SEE US ON THE WEB

C&S SALES, INC.

150 W. CARPENTER AVENUE
WHEELING, IL 60090
FAX: (847) 541-9904 (847) 541-0710
<http://www.cs-sales.com>



15 DAY MONEY BACK GUARANTEE

2 YEAR FACTORY WARRANTY

PRICES SUBJECT TO CHANGE WITHOUT NOTICE

Putting the Spotlight on BASIC Stamp Projects, Hints, and Tips

Stamp Applications

You Can't Touch That — Non-contact Access Control

Today, I had a bit of a headache and was feeling cramped in my office, so I decided to escape to the treadmill in the complex's private gym for a half hour or so. To keep it private, members gain access by waving a security card in front of a small plate adjacent to the front door. If the card is a match, ch-ching, the door unlocks and you're in.

Okay, what's going on with the card? You've probably seen them — they're everywhere. The cards in question contain technology called radio frequency identification (RFID). Even if you haven't heard of RFID, you may have been unknowingly exposed to it. RFID tags can be as small and nearly as thin as a postage stamp and are often used to track package movement in retail stores (big companies like Wal-Mart, Target, and others are adopting the technology). Drug companies are even putting RFID tags into their packaging to prevent piracy of expensive medicines. RFID is big news and now you can get in on it, too.

There are two essential components in an RFID system: a transceiver (reader) and a transponder (tag). If it were only that simple. Tags can be active (contain their own power source) or passive (create parasitic power from the reader's RF field). Further, tags can be read-only or read-write. Zoiks. Let's just keep things simple, shall we?

Parallax worked with world-famous hardware hacker and engineer extraordinaire, Joe Grand (owner of Grand

Idea Studio), to create a low-cost RFID reader that would be simple to use in hobbyist and professional projects. The result is a fully integrated reader printed circuit board that contains the required circuitry and matched antenna to work with pas-

sive, read-only RFID tags. Note that the reader is specifically designed for tags that contain low-frequency (125 kHz) RFID components from EM Microelectronic. Parallax carries a couple of tag types (disc and ISO card) that are manufactured by Sokymat and meet the requirements of the reader. Figure 1 shows a few sample tags from Sokymat that I played with; you can clearly see the disc tag (far left) and ISO card tag (far right).

Is it Magic?

Okay, how does it work? It's not magic; in fact, it's not terribly complicated. When power (5 VDC) is applied to the reader, a green LED will indicate that it's ready to function. By pulling the ENABLE pin low, the reader becomes active (LED changes to red) and the antenna broadcasts a modulated signal. If a tag is within range (up to four inches with the Parallax reader), it will harvest the RF energy with its own antenna and modulate its unique identification code in a manner that can be detected by the reader. A microcontroller on the reader tests the bits from the RFID tag to make sure the information is valid and then the tag number is converted to an ASCII stream to be transmitted on the SOUT pin at 2400 baud.

Keep in mind that, when the antenna is active (red LED), the device is broadcasting and consuming about 200 mA from the power supply. If you're going to do a project that involves batteries, you may want to add a physical button to activate the reader only when a card is actually present or use a timeout with **SERIN** (BS2 family only) to disable the reader periodically to reduce the load on the power supply.

Since RFID is so common in controlled-access and security systems, let's go that direction. And just for fun, let's build a super-simple, single-tag, access-control device with a BS1. Can we do it? Absolutely. In fact, the code is so simple, we can look at the whole thing in one shot:

```
Main:
  LOW Enable
  SERIN RX, T2400, ($0A, "0F0184F20B")
  HIGH Enable

Access_Granted:
  HIGH Latch
  PAUSE 2000
  LOW Latch
  GOTO Main
```

Figure 1. A handful of RFID tags.



We start by activating the reader (ENABLE pin is pulled low) and then simply waiting for a specific tag string. Let me correct something I left out: The tag ID string is preceded by a linefeed character (\$0A) and followed by a carriage return (\$0D). We'll see why this is useful a bit later.

In this program, **SERIN** does all the work. We construct the **SERIN** line to wait for the linefeed character, then the specific characters in the valid RFID tag string. Once that shows up, the program drops to the point called `Access_Granted`, where we activate an output that will do what we need it to do. We could, for example, disable an electric door lock that gives us – and just us – access to something special. After a brief delay, the lock-control output is enabled and we go back to the top.

The logical question is, “Where did you get the tag ID string?” We got it from the tag, of course. I just mentioned that the (ASCII) tag string is preceded by a linefeed and followed by a carriage return. We can put this to use by connecting the reader to a terminal program. Note that we need to go through an RS-232 line driver (e.g., MAX232, DS275, etc.) as the serial output is at TTL levels. Figure 3 shows the connections and Figure 4 shows the output when using a manually opened terminal from the BASIC Stamp IDE (note that the baud rate is set to 2400). In most cases, we'll use a BASIC Stamp to work with the reader, but be aware that you can also connect directly to a custom PC application using a simple interface as shown.

By the way, if you happen to have the new Parallax Serial LCD module, you can use it as a terminal and you don't need a level shifter. Simply set the LCD Mode switches for 2400 baud (1 = Up, 2 = Down) and connect the RFID reader's SOUT pin to the LCD's RX pin. Don't worry if it's not convenient for you to connect the RFID reader to a terminal or LCD, as we can always use a BASIC Stamp module to read and display an unknown tag string.

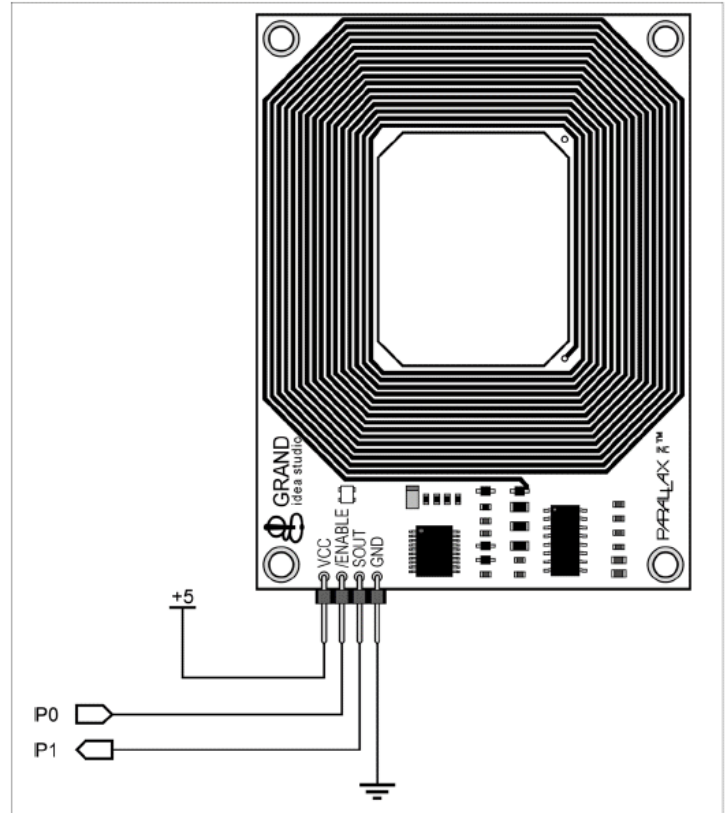

Figure 2. Connections to the RFID reader.

Open Sesame

Most security systems will have more than one legal user, so let's update the program to work with multiple tags. To be honest, I had to go back to the BS1 manual on several occasions for this program because the BS1 – while very cool – is not quite as convenient as its big broth-

MADELL TECHNOLOGY

www.madelltech.com

Madell Technology Corp. Phone: (714)614-4896
 7372 Walnut Ave, Suite V (402)319-4101
 Buena Park, CA 90620 E-mail: sales@madelltech.com

 AT850B Hot Air Rework Station \$140.00	 CA1640-20 20MHz Sweeping Function Generator/Frequency Counter \$260.00	 YSJ-250 Manual Stencil Printer \$325.00	 AE-R330 Tabletop convection reflow oven \$3950.00
 1 GHz Spectrum Analyzer / Function Generator AT5011 \$1225.00 AT5010 \$1025.00 AT5010B \$875.00	 AS-5001 Mini Automatic Reflow Oven \$798.00	 SJM7045TR Trinocular Microscope with Double Bar Boom Stand \$590.00 with Single Bar Boom Stand \$515.00	 QK5020 20 MHz 2-Channel Analog Oscilloscope \$250.00
			 QK702ESD 3-in-1 Rework Station \$449.00
			 ZD-9556 Orbital Shaker \$245.00

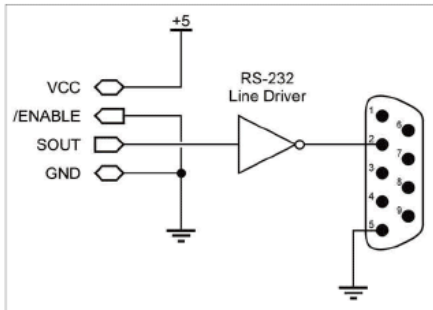

Figure 3. Connecting the reader to a terminal.

er, the BS2. It's very inexpensive though (especially with OEM parts), and is worth considering for a low-cost, access-control system.

After we've recorded our tag IDs, we can put them into a simple EEPROM-based

table for storage. Here's what my table looks like:

```
Tags:
EEPROM ("0F0184F20B")
EEPROM ("0F01D9D263")
EEPROM ("04129C1B43")
EEPROM ("0000000000")
EEPROM ("0000000000")
```

Remember that your table will be different, as the RFID tag strings are unique. By using the Memory Map feature of the Stamp IDE, I found I had room for five tags. Since I only had three to work with, I padded the table for the unused positions. A program constant will prevent us from searching past the known tag strings.

The next step is to set up our control outputs. For this security program, we'll turn off the reader and lock the door.

```
Reset:
HIGH Enable
LOW Latch
```

After basic setup, we drop into the heart of the program where the reader is activated and wait on a tag ID string.

Figure 4. Tag strings displayed in a terminal.

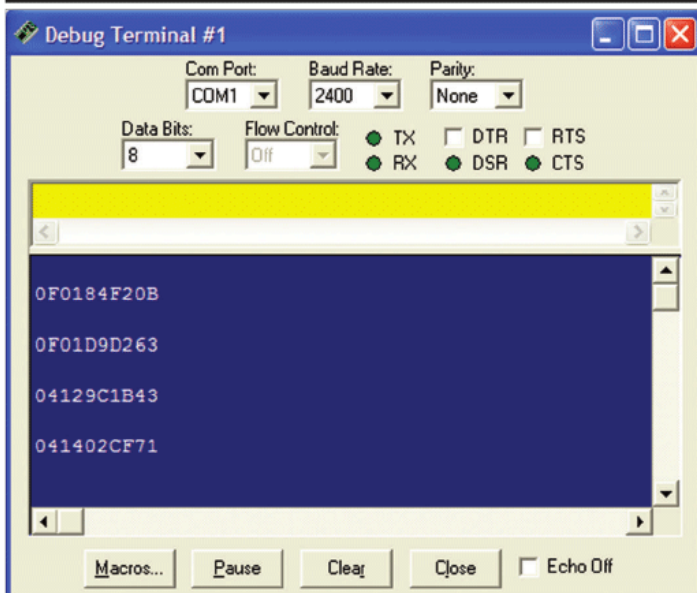

Now, you'll see what I was just talking about with the BS1 not being quite as convenient as the BS2. There is no STR modifier with the BS1, and its memory cannot be treated like an array. Everything must be done one byte at a time.

```
Main:
LOW Enable
SERIN RX, T2400, ($0A),
    → tag0, tag1, tag2, tag3, tag4,
    → tag5, tag6, tag7, tag8, tag9
HIGH Enable
```

Note that the **SERIN** line is really long, but needs to be on one line to make sure that all 11 bytes (header plus 10) are received properly. For publication, I've split the line, but you'll find it all together in the downloadable version of the code. With the tag ID stored in the BS1's RAM, we can compare it to our table entries to determine whether the tag presented is a match or not. Admittedly, this looks a little hairy, but it's really not that bad. To keep things concise, I'm only showing the first and last bytes, but the same code is required for all 10 elements of the RFID tag string.

```
Check_List:
FOR tagNum = 0 TO LastTag
  pntr = tagNum * 10 + 0
  READ pntr, char
  IF char <> tag0 THEN Bad_Char

  ` removed for clarity

  pntr = tagNum * 10 + 9
  READ pntr, char
  IF char <> tag9 THEN Bad_Char
  GOTO Tag_Found
Bad_Char:
NEXT
```

As you can see, comparing each byte of the RFID string against a table entry requires three steps that are placed in a loop: 1) We create a pointer to the corresponding position of the table entry, 2) we read the character from the table, and then 3) we compare the two bytes. If they don't match, the program jumps to the label called "Bad_Char" and we'll either move to the next table entry or, if we're at the end of the table, we'll fall through the loop. Let's say we do have a match. When that occurs, we will jump to the label called "Tag_Found" and execute the door-opening code:

```
Tag_Found:
DEBUG "Entry: ", #tagNum, CR
HIGH Latch
SOUND Spkr, (114, 165)
LOW Latch
GOTO Main
```

The latch is activated (to allow entry) and a beep is played through a piezo speaker of the amplifier circuit to alert the user. The beep stops after two seconds and the door relocks. Then, we go back to the top of the program.

When the tag presented does not match any of our table

entries, a one-second groan is played through the speaker:

```
Bad_Tag:
  DEBUG "Unknown Tag", CR
  SOUND Spkr, (25, 80)
  PAUSE 1000
  GOTO Main
```

And that's that. Like I said, it's really very simple. The trickiest part is working around the behaviors of the BS1, but even that wasn't so bad. Okay, let's port this baby to the BS2.

Starting back at the tags table, we're going to add names to each tag. In our demo program, we'll just send these to the Debug Terminal window, but we could just as easily put them on an LCD if we ever decide to add one to the project.

```
Tag1      DATA    "0F0184F20B"
Tag2      DATA    "0F01D9D263"
Tag3      DATA    "04129C1B43"

Name0     DATA    "Unauthorized", CR, 0
Name1     DATA    "George W. Bush", CR, 0
Name2     DATA    "Dick Cheney", CR, 0
Name3     DATA    "Condoleeza Rice", CR, 0
```

Note that the name strings are zero-terminated so that we're not restricted to a specific length. We'll get to the printing routine later.

Did you read last month's column? If not, why not?! Okay, I'll put my bruised ego aside and just point out that we're going to take advantage of the lessons on conditional compilation in this program. When I stated above that we would port the program to the BS2, I meant the BS2 family — the entire BS2 family. The first thing to consider is the RAM required to read the RFID tag string: 10 bytes. This is usually temporary in nature, and it would be really nice if we didn't have to use our variable space to handle it. Well, if we

use the BS2p or BS2pe, we don't have to; we can use the Scratchpad as a serial buffer. The first thing we have to do, though, is set up the program so that the compiler can detect a BS2p or BS2pe and create a symbol to that effect.

```
#DEFINE __No_SPRAM = ($STAMP < BS2P)
```

With this definition, the symbol called `__No_SPRAM` will be set to True if we're not using a BS2p or BS2pe — hence we are forced to define a buffer in our variable RAM space. Let's get to that:

```
#IF __No_SPRAM #THEN
  buf          VAR      Byte(10)
#ELSE
  chkChar      VAR      Byte
#ENDIF
```

Remember that conditional compilation is just that, conditional. It means that what actually gets compiled and downloaded will change based on the BASIC Stamp module we're using. In the code above, the array called "buf" is only created when using a BS2, BS2e, or BS2sx. When using a BS2p or BS2pe, we create a variable called "chkChar."

Now to the core of the program. What you'll realize is that, no matter which BS2 family module we use, receiving the RFID tag string in this program is much easier here than with the BS1. The only question is where those bytes will be stored and that is determined by the module in use.

```
Main:
  LOW Enable
  #IF __No_SPRAM #THEN
    SERIN RX, T2400, [WAIT($0A), STR buf\10]
  #ELSE
    SERIN RX, T2400, [WAIT($0A), SPSTR 10]
  #ENDIF
  HIGH Enable
```

Order online at:
www.melabs.com

Development Tools for PICmicro MCUs
microEngineering Labs, Inc.

Phone: (719) 520-5323
Fax: (719) 520-1867
Box 60039
Colorado Springs, CO 80960

Serial Programmer for PICmicro

\$119.95

Includes:

Programmer
9-pin Serial Cable
AC Power Adapter
ZIF Adapter for 8 to 40-pin DIP
Software for Windows 98/Me/NT/2K/XP

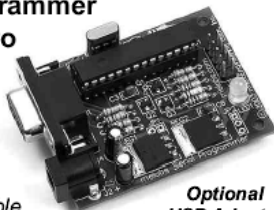

Optional
USB Adapter
\$39.95



**EPIC Parallel Port
Programmer
starting at \$59.95**

LAB-X Experimenter Boards



Pre-Assembled Board
Available for 8, 14, 18, 28,
and 40-pin PIC MCUs
2-line, 20-char LCD Module
9-pin Serial Port
Sample Programs
Full Schematic Diagram

Pricing from \$69.95 to \$349.95

PICProto Prototyping Boards



Double-Sided with Plate-Thru Holes
Circuitry for Power Supply and Clock
Large Prototype Area
Boards Available for most PIC MCUs
Documentation and Schematic

Pricing from \$8.95 to \$19.95

BASIC Compilers for PIC MCUs



Easy-To-Use BASIC Commands
Windows 9x/Me/2K/XP Interface

PicBasic Compiler \$99.95
BASIC Stamp 1 Compatible
Supports most 14-bit Core PICs
Built-In Serial Comm Commands

PicBasic Pro Compiler \$249.95

Supports all PICmicro MCUs
Direct Access to Internal Registers
Supports In-Line Assembly Language
Interrupts in PicBasic and Assembly
Built-In USB, I2C, RS-232 and More
Source Level Debugging

See our full range of products, including
Books, Accessories, and Components at:

www.melabs.com

When we're using a BS2, BS2e, or BS2sx, the tag string is stored in our variable buffer; otherwise, it gets stuffed into the first 10 bytes of the Scratchpad. See how much easier this is? The STR and SPSTR modifiers are huge time-savers here.

With the tag string in RAM, we can compare it against the table, and again, it's much easier with the BS2-family.

```
Check_List:
FOR tagNum = 1 TO LastTag
FOR idx = 0 TO 9
READ (tagNum - 1 * 10 + idx), char
#IF __No_SPRAM #THEN
IF (char <> buf(idx)) THEN Bad_Char
#ELSE
GET idx, chkChar
IF (char <> chkChar) THEN Bad_Char
#ENDIF
NEXT
GOTO Tag_Found
```

```
Bad_Char:
NEXT
```

As with the BS1, a loop is used to work through the known tag strings. What we're able to do here, however, is use a second loop to test each byte of the received string. The inner loop reads the appropriate byte from the current tag data and compares it against the corresponding tag

byte from the reader. Our conditional symbol sets up the code to make the comparison against a byte in the variable array or against a byte from the Scratchpad. Note that the Scratchpad cannot be treated like an array, so we are forced to use **GET** to access the appropriate byte.

Moving on to a good tag, we will do the same as before: sound the beeper (with **FREQOUT**) and disable the security lock. Remember that **FREQOUT** is one of those instructions that differs from Stamp to Stamp, so conditional compilation constants are used to keep the timing (two seconds) and tone (880 Hz) the same, no matter which module we use.

```
Tag_Found:
GOSUB Show_Name
HIGH Latch
FREQOUT Spkr, 2000 */ TmAdj, 880 */ FrAdj
LOW Latch
GOTO Main
```

We've also added the ability to display the name of the person who is assigned to the valid tag. A simple loop will send the characters of the name to a display. We'll keep it easy and use the Debug Terminal.

```
Show_Name:
DEBUG DEC tagNum, ": "
LOOKUP tagNum,
[Name0, Name1, Name2, Name3], idx
DO
READ idx, char
IF (char = 0) THEN EXIT
DEBUG char
idx = idx + 1
LOOP
RETURN
```

The result of the tag search (in the variable tagNum) will be from one to the number of known tags if the tag string is valid. If not, the search will result in zero. The "Show_Name" routine uses the result of the tag search to **LOOKUP** the first character of the corresponding name. After that, each character is printed in a loop until the zero-terminator is encountered. We could very easily change the **DEBUG** line to **SEROUT** for a serial LCD or to **LCD-OUT** if we're using a BS2p or BS2pe and have a parallel LCD connected as required.

Well, that's it. That was pretty simple, wasn't it? I think so and I'm having a lot of fun with the RFID reader. Be sure to check out the resources listed, as there is lots of interesting information on RFID technology. Joe Grand's website has some really cool stuff (if you're into hardware hacking, you'll love his books).

Until next time ... Happy Stamping! **NV**

www.parallax.com
www.grandideastudio.com
www.rfidjournal.com
www.emmicroelectronic.com
www.sokymat.com

Web Resources

Learn Wireless Communication Technology and FCC License Preparation at HOME! Free Information Packet

Prepare today for a new challenging and exciting career. Our Distance Learning Program is designed to train you at home in your spare time. Call today to get started.



Our new program in Wireless Communication Technology can open up a new world of income opportunities for YOU and NO classroom attendance is required.

Send to Aii, Inc., Dept. N&V 1203 - 2725 College St., Jacksonville, FL 32205

Name _____ Age _____

Address _____ Ph: () _____

City/State _____ ZIP _____



Atlantic International Institute, Inc.

www.Aiilearn.com Email: info@aiilearn.com
Call TODAY For free Information Packet

Toll FREE 1-800-658-1180

Profiting from the
1st New Industry
of the 21st Century

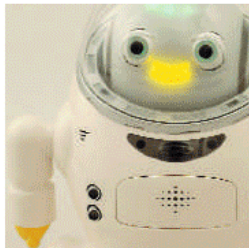

Produced by



RoboticsTrends



Founding Sponsor



Premier Sponsors



Evening Reception Host



Premier Media Sponsor

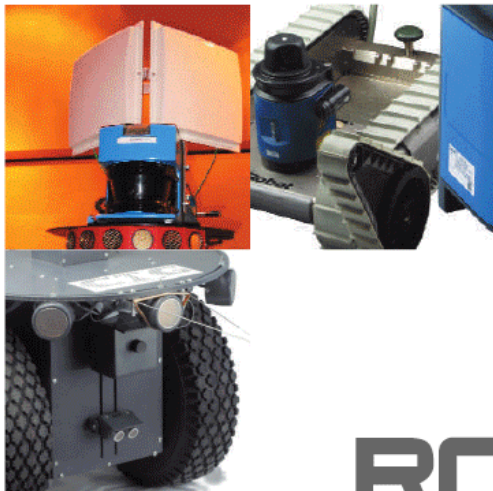

SECOND ANNUAL

ROBOBusiness Conference and Exposition

The Nation's Premier Business Development Event
for Mobile Robotics and Intelligent Systems

May 10-11, 2005
Hyatt Regency Cambridge
Cambridge, MA

www.roboevent.com



Photos courtesy of iRobot, SICK, K-Team, CTG, Business Design Lab, ActivMedia Robotics, LLC.

Corporate Sponsors



Media Sponsors



Association Sponsors



The Business of Electronics Through Practical Design and Lessons Learned

In The Trenches

Project Engineering Tasks

There are a series of steps that are usually followed in most engineering development cycles. It's important to know what these are and what they entail, and this is especially true for the new engineer or new engineering business venture (independent consulting). This month, we'll go over these basic steps and explain what they consist of and why they are important.

Being Professional

There is always an expectation of professionalism in any business activity. Engineering is no exception. Professionals do things in a particular way because it works best and because that's what the customer wants. If you don't provide what your customer wants, you won't be in business very long. Also, if your approach doesn't work, well, that's bad, too.

Fundamentally, if you don't act like a professional, you won't be seen as a professional. If you aren't seen as a professional, you won't have credibility. If no one believes you, it doesn't matter how brilliant, innovative, or original your ideas are.

It's always important to remember that engineering is a creative process. An engineer takes an idea and makes it real. All good engineers relish any opportunity to unleash their imaginations in their designs. Being professional doesn't mean being conventional; it only means that the ideas are presented and built in a conventional manner. The more believable you are, the

more likely it is that your idea will be accepted.

All of this leads up to the approach you should follow in working with clients and others when developing a project. (Note that the term "project" is being used here in a business-engineering sense rather than a hobbyist sense.) The approach, detailed below, is pretty standard. There are variations (and some of these will be discussed), but if you are building a space ship or a better mouse trap, these steps are important. Some people may give different names to the steps, but the steps and their order are fairly fixed.

Preliminary Design Review

This is collecting information about the project and deciding on a general approach or solution. A client may call up and say, "I need a new front panel controller for my exercise machine." In this case, you will sit down with the client and find out, in detail, what he wants, when he wants it, the price he is willing to pay, and other necessary points. The client may provide direction about the solution he wants. "I want an LED display, not LCD." If he does, ask him why. His reasons will tell you about his level of understanding. Also, they may be based on inaccurate or outdated information.

If so, you may want to gently correct him with something like, "With the new products on the market today, that's not a big concern anymore." If you think it's important to

use the LCD instead of LEDs, find out if there are conditions under which the client will accept an LCD, but never, never argue with the client. Always remember that the client is willing to give you money. Who else is going to do that?

One objective of the Preliminary Design Review is to define a very specific goal. This goal is something that can be detailed objectively in a document without dispute. There is nothing worse than providing a "finished product" to a client who says, "That's not what I wanted!" (This happens much too often, especially with startup consultants who don't follow these basis steps.)

Another objective is to determine which approaches are acceptable to the client. Obviously, it's best for the engineer if all approaches are acceptable. He is free to use his full imagination. In reality, there are always limits in cost, size, complexity, delivery, and other factors (that the client may not even be aware of).

Return for Quotation

Sometimes, with large companies and the government, the Preliminary Design Review is written and provided to the engineer in some manner. Typically, this is an RFQ or "Return for Quotation."

This is a document that provides all the necessary details needed to complete the project. It includes the goals and approaches that are acceptable to the client. It also includes information about delivery schedule, size, etc. Pricing

may or may not be stated directly. Often, the lowest bidder will be awarded the contract. Often, the engineer (or his company) is barred from contacting the RFQ client to obtain additional details or answer questions. This is done to provide for "fair" competition, but clearly, this can create difficulties for the engineer. Who knows if the client really wants an LCD or LED display? The cost and performance are different. Which is better? In cases like this, you just do your best.

Engineering contests (like *SERVO Magazine's* Hack-A-Sapien) are a form of RFQ. In these cases, originality is an important factor in winning. Sometimes, contest goals are very specific, like "self-navigate from Point A to Point B in the shortest time." Sometimes, they are vague, like "most outrageous hack." Nevertheless, these contests are really RFQs in disguise.

Paper Design

The next step is to consolidate all the information you got from the client (or RFQ) and decide which approach is the most appropriate for the client. Always remember that you are working for the client and you want to make him happy. While you may enjoy designing, you must always put the client's needs first.

You should have a number of possible approaches. Within an engineering company, meetings are often held to decide the good and bad points of each idea. If you are consulting on your own, you should always examine several different ways to satisfy the customer. If you set your mind to a fixed solution, it often causes problems later.

Once the approach is determined, a comprehensive paper design is created. This includes a complete schematic, physical dimensions, parts list, production cost estimate, testing fixtures, special assembly details, theory of operation, computer simulations, and anything

else that is needed to define the product.

If this sounds like a lot of work, it is, but this step is often critical to the success of the project. This paper design can uncover fundamental problems that must be corrected. It's clearly better to fix a paper design than to rework hardware. This also helps everyone understand all the aspects of the whole project rather than just their own small part of it. As I recall, the paperwork for the B-1 bomber weighed more than the bomber itself.

It is not unheard of to create two paper designs and let the customer decide which is best. If you really have a great idea that doesn't match what the client has stated, but you think he'll like it, this may be the way to go.

You can provide your design along with the design that matches the client's specifications. Placing two

proposals side by side and showing the client how one is better than the other is often a good way to sell your idea.

Occasionally, this stage includes "proof of concept" hardware (or software). If you are proposing a solution that is unique or controversial, it is very helpful for the client to see the idea in action. This gives you — and your idea — credibility and helps the client understand the principles of the approach. This hardware does not need to be a finished product. It only has to demonstrate that the idea is workable.

Design Review

This is when you sit down with the client again and go over your paper design. You show him the good and bad points of the design, and always tell the client about the bad points up front. There are two rea-

1010 Jorie Blvd. #332
Oak Brook, IL 60523
1-800-985-8463
www.atomictime.com

ATOMIC TIME



Office School Clock #1
WT-3121A \$39.95>

This wall clock is great for an office, school, or home. It has a professional look, along with professional reliability. Features a manual set option, daylight saving time disable option, and a safe plastic lens and case.



Atomic Digital Wristwatch
< H15U \$34.95

A high tech digital wristwatch with a sophisticated look. Features a metal 'stretch' band and a high-contrast digital display. 12/24 hr time formats, backlight, date, and day of week.



Arcron Atomic Watch
<S6G24-4 \$249.99

This elegant watch features a shock-resistant titanium case with hardened mineral lens. Silver dial with arabic numerals, and high quality replaceable leather band. Watch can change to any world time zone. Case diameter 40mm. Made in Germany.

1-800-985-8463
www.atomictime.com



LaCrosse Digital Wall Clock \$34.95

This digital wall / desk clock comes with a beautiful cherry wood frame. It shows time, date, day of week, temperature and moon phase. 12/24 format.

Tell time by the U.S. Atomic Clock - The official U.S. time that governs ship movements, radio stations, space flights, and warplanes. With small radio receivers hidden inside our timepieces, they automatically synchronize to the U.S. Atomic Clock (which measures each second of time as 9,192,631,770 vibrations of a cesium 133 atom in a vacuum) and give time which is accurate to approx. 1 second every million years. Our timepieces even account automatically for daylight saving time, leap years, and leap seconds. \$7.95 Shipping & Handling via UPS. (Rush available at additional cost) Call M-F 9-5 CST for our free catalog.

sons for this: First, if these points are to be fixed in some manner, it is better to do this at the start of the project while it's still on paper.

Second, honesty with the client cannot be overestimated. If the client thinks — or finds out later — that you are keeping secrets from him, he will not be happy. (How would you react if your doctor neglected to tell you that the medication you were taking for high blood pressure might cause all of your hair to fall out?)

There are always changes to the design at this point. The client forgot something, your approach gives him a new idea, or some initial information was incorrect. There's always something.

However, if you did the first two steps properly, these changes will usually be relatively minor and easy to accommodate.

Sometimes there are significant

modifications requested. This is called a "Scope Change" and basically means that the scope, or overall approach, of the design must be re-evaluated.

In this case, it's back to Step 1. This Design Review becomes another Preliminary Design Review. Another paper design must be created and another Design Review is required.

It is important to note to the client any significant production, servicing, or testing considerations here.

For example, going from through-hole to surface mount technology (SMT) may require a substantial financial investment in hardware and training. As noted above, never surprise the customer.

For RFQs, this Design Review is completed by the client. The client examines the paperwork submitted by the engineer to determine if it is

suitable. If so, then a contract is awarded (or, for a contest, a prize is given). It is at this point that the engineer is able to contact the RFQ client for any additional details or questions.

Build a Prototype

This prototype (or two or three) is a fully functional product; however, it may not have exactly the same characteristics as the final version. For example, the final version may specify tiny SMT parts that require special machines to solder to the printed circuit board (PCB). This prototype may use through-hole or larger SMT parts that can be handled manually.

It used to be that prototype circuits were wire-wrapped, but this is rare nowadays. Nearly all modern prototypes use a PCB in order to validate performance characteristics.

Parts List Software for Engineers and Designers

- Easily create and manage multi-level parts lists for products in development...and after.
- Track sources for items with multiple price breaks.
- Calculate product costs at any quantity.
- Launch CAD, viewer or browser from any item.
- Automatically generate RFQs or POs.

New Version 5.0

- **New Report Layout Editor** customizes reports/labels.
- **New Connection to QuickBooks 2002/2003 Pro** simplifies accounting (us version only).
- **New Multi-currency** for foreign suppliers eases exchange rate calculations.

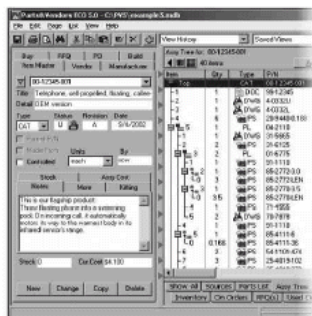

For Windows
98/NT/Me/2K/XP
3 Editions,
starting at
\$99 + s/h

Parts & Vendors™

Visit www.trilogydesign.com
and download our FREE DEMO.

Trilogy
DESIGN

Or, Call 800-280-5176
530-273-1985 Fax 530-477-9106
P.O. Box 2270, Grass Valley, CA 95945

Instant LCD Gratification...



\$149 2.7" Color LCD
ezLCD Intelligent LCD Module



\$199 2.7" Color LCD
ezLCD Development Kit

Incorporate a COLOR LCD in your project in no time!

PROGRAMMING FEATURES:

- Programmable Display Module
- Serial+USB+Parallel Interface
- iPC/AVR/BASIC Stamp/VB Compatible
- Onboard Flash Bitmap Memory
- Graphic/Text Commands
- Downloadable TTF Fonts

DISPLAY FEATURES:

- Sony 2.7" Color TFT LCD
- 240x160 QVGA
- Transflective with LED Frontlight
- Sunlight Readable

ezLCD-002
with Touch Screen
Available by April!

Why can't everything be
this quick and 'ez'?

EARTH.LCD.COM

We Make LCDs Work.™

This has lead to the tremendous growth of the fast turnaround PCB manufacturing market. There are lots and lots of these houses that specialize in low-cost (relatively speaking) PCBs with a one- to three-day delivery time.

This has also lead to significant competition, which has resulted in a nice fallout for hobbyists. There are now PCB houses that actively target hobbyists with low prices and fast delivery times. I counted four such advertisers in a recent *Nuts & Volts* issue.

This prototype may be physically different, as well. In particular, a simple box may substitute for a custom case. This is because the set-up costs and lead time for the custom case are significant. No one wants to spend all that time and money only to find out that the client expected something different.

There will be production differences in this prototype, too. Suppose the final design calls for a special injection molded plastic part. Again, this requires significant setup costs and lead time. The prototype may use a plastic piece made in the machine shop instead.

Note that all of these variations and differences don't actually change the functionality of the prototype. It must perform as expected. It simply looks different and is built by hand rather than mass-produced.

Product Design Review

This is another meeting with the client to demonstrate the prototype and verify that it meets the customer's needs. In particular, the prototype is compared to the requirements specified from the previous Design Review. Every functional aspect of the prototype is examined in detail. Good and bad points are discussed. Special attention is given to the differences between this prototype and a production unit. The client cannot make any major changes to

the design at this point without incurring significant cost increases and time delays. Minor changes, however, can be incorporated with little or no penalty.

This review also includes production and test considerations. Producing many units is very different from making a couple of prototypes. Making sure that they work (testing)

properly is something that should have been considered very early on, but this is usually the point where the customer is informed of specific needs (unless exceptional tests are needed – then they should have been noted in the Design Review). There may be special calibration procedures that need a particular piece of test equipment. A time estimate for

Embedded Solutions.

Dozens of Embedded Controllers with Countless Configurations to fit ANY Industry.

ATMEL AVR[®] Based Controller

Micro64[®] AVR[®] Based Controller

Pin 1 www.micromint.com

- Small size - 1.5" x 2.1" x 0.52
- Dual powered - operates on +5V or 6.5-20V at 55 mA (typical)
- Program and Data Memories
 - 64k or 128k Bytes of In-System Reprogrammable Flash with 10,000 Write/Erase Cycles
 - 2 or 4K Bytes EEPROM with 100,000 Write/Erase Cycles
 - 36K Bytes SRAM
 - Programming lock for Software Security
- Peripheral Features

Starting at \$119 - Single Qty

- Optional 2-channel 12-bit ADC
- 8-channel 10-bit ADC
- 8 Single-ended Channels
- 7 Differential Channels
- 2 Differential Channels with Programmable Gain (1x, 10x, 200x)
- Byte-oriented Two-wire Serial Interface (I²C)
- Dual Programmable Serial USARTs
- 1 TTL
- 1 RS-232A, RS-422, or RS485
- Master/Slave SPI Serial Interface
- Two 8-bit Timer/Counters with Separate Prescalers and Compare Modes
- Two Expanded 16-bit Timer/Counter with Separate Prescaler, Compare Mode, and Capture Mode
- Two 8-bit PWM Channels
- 6 PWM Channels with Programmable Resolution from 1 to 16 Bits
- Programmable Watchdog Timer with On-chip Oscillator
- 29 Digital I/O that can sink or source 20 mA

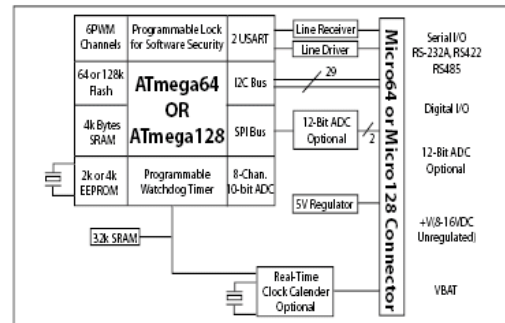

Data sheets, Online Ordering and a Complete Catalog of Products at...

www.micromint.com

Reduce Your Time to Market.



Minimize your time from conception to production by utilizing one of Micromint's market-proven controllers. Whether your concerns are digital or analog, inputs or outputs, Micromint has a product to fit your needs. Order quantities of one to thousands. Custom design and configurations are available.

With over 500,000 controllers in the marketplace, Micromint has been providing innovative, turn-key solutions to the OEM market for 24 years—from design through production, as well as packaging and shipping the final product. Our broad line of embedded controllers and turn-key solutions can turn your imagination into reality.

Visit our website @ www.micromint.com to see our complete line of OEM Solutions.

Micromint

115 Timberlachen Circle | Lake Mary, FL 32746 | 800-635-3355 | 407-262-0066 | Fax 407-262-0069

Circle #123 on the Reader Service Card.

Nuts & Volts on CD?



\$29.95

plus \$4.95 s/h USD

**You asked for it,
you got it!**

(Well, coming soon anyways!)

Starting with calendar year 2004, we are archiving a year's worth of issues on a CD that can be searched, printed, and easily stored.

You'll be able to purchase said disk from us for your own personal use and dispose of your old paper copies that are collecting dust in the garage. (Your spouse will love you for it!)

We will also be archiving earlier years as well, so stay tuned for their availability.

The expected shipping date is May 15th.

To pre-order, go to:

www.nutsvolts.com

or call

1.800.783.4624

or send a check or
money order to:

Nuts & Volts
430 Princeland Court
Corona, CA 92879

In The Trenches

testing is important information for the client.

New production/test machines or special training might also be needed for production. This is where you define exactly what is needed and where to get it.

For example, if the customer needs an oscilloscope for testing, you should specify the important specifications of the oscilloscope (bandwidth, etc.) and provide any manufacturers and models that may be suitable.

It should be noted that, with faster and faster time-to-market development cycles, Steps 4 and 5 are sometimes skipped. Instead of building a prototype and letting the customer examine it, the cycle jumps directly to building a production prototype. This is faster, but carries some risks. A production prototype requires more resources and may include financial commitments that are not needed for an ordinary prototype.

Build Production Prototypes

With the information from the client in the Product Design Review and performance data from the prototype, a small number of production prototypes are built. The number depends upon the size and complexity of the product. Typically, it's three to six units.

This step has two main purposes. The first is to show that the product can be built in quantity with consistent performance. With a handful of units, you can compare performance and see the variations between them. If the design or approach is poor, it simply may not be possible to produce units with repeatable performance. Talk to any production manager. He'll have plenty of stories to tell.

The second purpose is to create some "production" units without actually having to set up a full-blown production run. These prototypes are virtually identical to the final product

in every way.

By necessity, there are very slight differences from the actual production units. This is because of the small quantity of the prototypes produced.

For example, parts may be soldered by hand instead of using a wave-solder machine, or the front panel cut-outs may be drilled at the machine shop rather than with a punch-press machine. The performance, form factor, look, and feel will be identical to the full production units, though.

There is one very important additional difference. These units generally don't pass any quality control tests. They are handcrafted and tested for functionality, but their solder connections are not inspected, nor are the crimp connections, etc. Quite often, engineers themselves will replace parts and, while most engineers can solder adequately, few would pass quality standards.

This means that the prototypes are not suitable for selling. It is important to stress this to the client. Never sell a prototype! It's bad business. Besides, some time in the future, someone will need a unit for something (an upgrade, revision tracing, or testing). Use the prototypes for that.

The drawing package (documentation) is also assembled at this stage. Note that I say "assembled" rather than "generated." This is because documentation should always be an ongoing effort. Creating everything at the end takes longer, is less accurate, and is rarely complete.

The documentation (for a typical electronic product) should include the items on the following list. Note that the list is not exhaustive and is really more of a minimum guideline. Think of what documentation you would like in order to manufacture the product and then include it.

1. A complete schematic diagram. It should be annotated by the design-

er to show expected signals, critical test points, and other useful information.

2. A parts list. This is a list that gives the values and ratings of parts. It is always useful to provide a catalog part number from a major distributor so that the purchasing department can easily identify the part. You should also be sure to identify critical parts and explain why they are critical.

3. Assembly drawings. It is said that a picture is worth a thousand words. A simple diagram that shows how all the parts fit together is vital. (How would you like to put together all those Christmas presents for your kids without the pictures and diagrams?) These only have to be as detailed as necessary. They don't always need to be full mechanical blueprints.

4. Assembly procedures. There are often special tricks or methods used by the design engineer to simplify the assembly. If they stay with the engineer, then they aren't very useful. So, they should be passed on. For example, using a magnetic nut driver may make a hard-to-reach fastener easy to attach.

5. Test procedures. Testing is a critical factor in producing a quality product. (Hopefully, you designed it to make the testing easy and quick.) You should always specify a range of values rather than a specific value.

For example, you should say 4.5 to 5.5 volts — not 5.0 volts. Also, specify what instruments are needed and their basic capabilities. Any test fixtures should be defined, as well. Provide a complete drawing package for that, too.

6. Troubleshooting guide. Now, this is something that does not have to be overly detailed, but it should address the most common expected failures. Special hints about how to

isolate and attack problems can be very helpful. Remember that most of the faults in production come from bad solder joints or improper assembly rather than from failed components.

7. Theory of operation. This step should include the basic concepts of how the product works. It's usually used in conjunction with troubleshooting, but it is used, sometimes, to familiarize technicians (or other engineers) with the product. It is also very useful to include the design engineer's notes (about design approach, problems, fixes, changes, etc.). This helps in understanding the reasons for the design long after the design cycle has finished (and the engineer has moved on).

Final Acceptance Test

This is the last step. If all of the other steps were performed properly, then this should be routine. The production prototypes and drawing package are delivered to the client. The client tests the product to verify that it does, in fact, work as expected. If so, then the client accepts the design and pays the engineer or his company. If not, then it's back to the drawing board! This acceptance test then becomes another Product Design Review and you take it from there.

Conclusion

There are seven basic engineering tasks that are used in the typical product development cycle. They are pretty much the same for any design endeavor.

Although, for fast time-to-market designs, only five steps are used and there are risks in doing that. Understanding what these steps are and what they entail is important for every engineer, as well as anyone who happens to work with engineers. **NV**

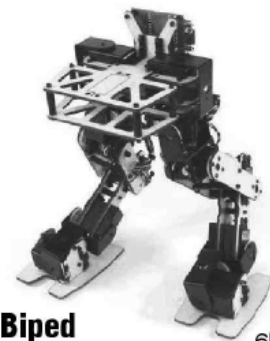

Biped Scout 6DOF Biped Walker

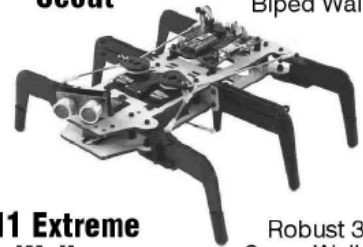

H1 Extreme Walker Robust 3 Servo Walker

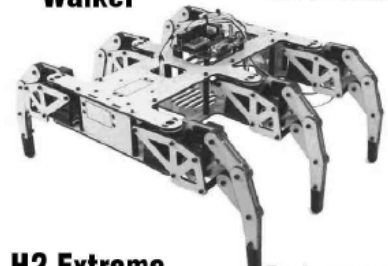

H2 Extreme Walker Performance 12 Servo Walker



Lynx 6 Robotic Arm Five DOF Arm



4WD2 Rover Articulating Chassis

We have many more unique robot kits. Our robots feature:

- Precision Laser-Cut Lexan
- Preassembled Electronics
- Custom Aluminum Components
- Injection Molded Components
- Very High Coolness Factor

Toll Free: 866-512-1024
Web: www.lynxmotion.com

CLASSIFIEDS

CLASSIFIED ADVERTISING

\$50.00 Per Inch — No extra charge for color (Limited time offer).

Classified ads must be paid in full prior to the closing date. Visa/MC/Amex accepted. Payment for ads received after the closing date will cause the ad to be placed in the following issue, at our discretion. Minimum charge is one inch with half-inch increments.

No proofs will be sent. Ads to be typeset by Nuts & Volts must be received by the closing date. Supplied ads must be received by the artwork due date.

Call the office at 951-371-8497 or Email classads@nutsvolts.com for closing dates, available sizes, and special prepaid discount offers.

Components



RF PARTS™ CO.
From Milliwatts to Kilowatts™
Tubes, Transistors, Power Components.
Email: rpf@rfparts.com • Web: www.rfparts.com
800-737-2787 Fax 888-744-1943

Floating Point Coprocessor
12C to 400 kHz
SPI to 4 MHz
32-bit IEEE 754
32-bit integer
Math functions
User defined functions
8-pin DIP or SMT
www.micromegacorp.com

RF Transistors, Aluminum Boxes, Heat Sinks, Copper Boards, Transformers
25C1969 25C2879 SDI446 25C2290
See our website for other products
www.westgateparts.com
Westgate 1-800-213-4563

FREE 120 Pg CATALOG
Electronic components, kits, test equipment, tools, and supplies for hams, hobbyists, and businesses. Many hard-to-find items like variable capacitors, vernier dials, coil forms, magnet wire, and toroids.
Ocean State Electronics
www.oselectronics.com

Printer Supplies

Hard-to-find Printer Ribbons
INKJET REFILLS INKJET CARTRIDGES AT DISCOUNT PRICES
Write for price list or check out our web page.
H.T. Orr - Computer Supplies
249 Juanita Way
Placentia, CA 92870-2216
TOLL FREE 1-800-377-2023
LOCAL 714-528-9822
FAX 714-993-6216
email: Htorr@aol.com
<http://users.adelphia.net/~htorr>

NUTS & VOLTS

Robotics

ROBOTIC CONTROLLERS
Robot Bases, PIC, OOPic, Stamp and servo controllers. New Walking Machine Controller. Chips, kits, assembled.
www.oricomtech.com

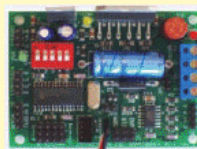
The Smart Motor Controller

Gamatronix
* Closed Loop PID Control
* Trapezoidal motion profiles
* I²C, Serial, & Cricket ports
* Current (torque) feedback
www.gamatronix.com

Speakers

PARTS EXPRESS
YOUR ELECTRONICS CONNECTION
The Audiophile Source
• Speakers
• Electronics
• Connectors
• AV Accessories
Call for a Free Catalog
1-800-338-0537
or visit us at
parts-express.com
SOURCE CODE: NVM2

Security

Card-Access

• Low-cost access ctrl.
• Expandable system
• Door/gate relay control
• Windows host software
• Controllers from \$69
• RS-485 Multi-drop
• Reseller discounts
www.kadtronix.com

www.matco.com
4 Channel Network DVR
IP Solution **DVR-2200-W** \$499/ea
30 fps full size/120 fps quad size; Up to 250 GB optional HDD; Dynamic or statistic IP; Internet accessible; Wavelet compression format; Alarm input/output; Video loss detection; Multiple quick search; POP/PIP; RS-232, RS-485 comm.
(800)719-9605 sales@matco.com

consumertronics.net
Hi-Tech Survival Offers!
Electronics, security, energy, computers, Net, phones, medical, legal, financial, weird. **Cat.\$1**

www.matco.com
Miniature CMOS Camera
CML-100/CMP-101
1/4" CMOS, 380 TVL,
3 Lux/F2.0, 3.6/5.5mm Lens
B/W: \$29/ea Color: \$39/ea
Weather Proof Infrared Illuminator CCD Camera
B/W: AX-808 \$119/ea
1/3" CCD Sensor, Built-in 11 IR LEDs, 380 TVL, 0Lux/F2.0, AI, BLC, 4.3 mm Lens, 5' Cable
Color: AX-808C \$149/ea
1/4" CCD Sensor, Built-in 11 IR LEDs, 330 TVL, 0Lux/F2.0, AI, BLC, 3.6 mm Lens, 5' Cable
(800)719-9605 sales@matco.com

Scientific Organizations

Amateur Scientists Unite!
www.sas.org/unite

www.matco.com
18 Ch 12 VDC Power Distribution Box \$99/ea

12 VDC regulated, Total current 6A, 18 outputs, 333 mA per terminal, 18 terminal blocks, Fuse on each channel, 18 female power connectors on PCB board for easy connect to camera cable. 16"W X 9.5"H X 3.5"D
XF#250DC-6A/18
(800)719-9605 sales@matco.com

ZAP CHECKER MODEL 270
WIRELESS INSTALLATION METER
for WIFI, WLANS & SURVEILLANCE
WITH LOG PERIODIC 1.8-4.5 GHz Ant.
• Aims and Aligns Antennas
• Tests Transmitter/Antenna Output
• Measures Baseline RF and RFI
• Identifies HOT and COLD spots
• Finds Hacker Sites & Cable Leaks
• Optimizes Hub Placement
\$329 w/ directional 1.8-4.5 GHz Ant. (1-5' SMA) Cables add \$229/ea
ALAN BROADBAND CO.
93 ARCH ST., REDWOOD CITY, CA 94062
TEL: (650) 369-9627 FAX: (650) 369-3788
WWW.ZAPCHECKER.COM

PROFESSIONAL EAVESDROPPING DETECTOR
2.4 GHz BUGS detected at 100+ feet
ZAP CHECKER MODEL 270 with 2.4 GHz YAGI ANTENNA \$549
• DETERMINES DIRECTION
• SUPER FAR-FIELD DETECTION
• HOMES-IN & PINPOINTS LOCATION
• 10 MHz - 4.5 GHz BANDWIDTH, -70 dbm at 2.4 GHz
ALAN BROADBAND CO.
(650) 369-9627 (888) 369-9627 FAX: (650) 369-3788
WWW.ZAPCHECKER.COM

SPY EQUIPMENT
BEST PRICES GUARANTEED on CCTV and counter spy products!
914.699.2294
www.mjelectronics.com

www.matco.com
USS Counterfeit Detector
MES-2036 \$99/ea

Check the security thread, magnetic ink, IR ink and paper texture, Beep and red light alarm when fake note detected. Capable for both new and old version USA banknotes (~\$1). Built-in UV lamp for manual check.
(800)719-9605 sales@matco.com

www.matco.com
Real Time 4 Channel PC Based Digital Video Capture Card
Internet Accessable
Real Time DVRC-TD4
30/30 fps, 320 x 240, Local & Remote PTZ control, 4 BNC Video Input, S/W included
\$69/ea Plug and Play
(800)719-9605 sales@matco.com

CLASSIFIEDS

Connectors Wire/Cable

The RF Connection
213 N. Frederick Ave., Ste. 11N
Gaithersburg, MD USA 20877
<http://www.therfc.com/>

Complete Selection of MIL-Spec Coax, RF Connectors and Relays

UG-21B/U N Male for RG-213/214 \$5.00
UG-21D/U N Male for RG-213/214 \$3.25
N Connectors for 9913/Flex4XL/9096
UG-21B/9913\$6.00 / Pins Only.....\$1.50
UG-21D/9913\$4.00 / Extra Gasket.\$0.75
Amphenol 83-ISP-1050 PL-259 \$0.90
UG-176/U Reducer RG-59/8X, \$0.25
or 5/\$1.00
UG-175/U Reducer RG-58/58A, \$0.25
or 5/\$1.00
Silver Teflon PL-259/Gold Pin, \$1.00
or 10/\$9.00

MIL-Spec Coax Available (Teflon, PVC IIA)
New Product: Belden 9913F, 9913 with
High Density PE Foam dielectric,
stranded center cond. and Duobond
III Jacket \$0.80/ft or \$76.00/100ft
Also New: 9092, RG8X with Type II Jacket.
Intro Price\$23.00/100ft

Call for Specials of the Month

Full Line of Audio Connectors for Icom,
Kenwood, and Yaesu
8 Pin Mike Female \$2.50
8 Pin Mike Male Panel \$2.50
13 Pin DIN for Kenwood \$2.75
8 Pin DIN for Icom \$1.00
8 Pin DIN for Kenwood \$1.50

Prices Do Not Include Shipping

Orders **800-783-2666**
Info **301-840-5477**
FAX **301-869-3680**

Audio/Video

www.matco.com

VGA to Video Converter ULT-2000



\$85/ea

- Use big video screen as PC monitor
- Capture PC images on video recorder
- 24bit, 16.7 mil colors

Video to VGA Converter VGA-802



\$69/ea

- Display Composite Video or S-Video signal on PC monitor
- Works w/ or w/out PC
- Stereo Audio amp.
- 24bit, 16.7 mil colors
- Powered by 5 VDC

(800)719-9605 sales@matco.com

www.matco.com

2 Inputs Digital Video Web Server

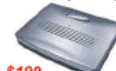

\$199

DVR-1000-WS

- Broadcasts 2 composite video sources on Internet
- 10/100 Base-T network interface
- Statistic or dynamic IP
- 15 fps. IE Browser display
- Auto e-mail or image FTP when alarm triggered
- Built-in Auto Network Reconnection function

(800)719-9605 sales@matco.com

www.matco.com
Video Modem System



\$79/set

VDS-2200

- Send Video, Audio Signals & 12 VDC Power over one RG59 Cable
- Transmit range >1mile
- Interference & noise free
- Whether Proof design
- 110 VAC to DC adjustable power adapter included

(800)719-9605 sales@matco.com

Batteries/ Battery Chargers

Smart Battery Charger

FOR GEL-CELLS or
LEAD ACID BATTERIES



New & Improved

Features: Precision temperature tracking voltage reference & three mode charging sequences. Standard kit is for 12V @ 1/2 or 1 Amp, user selectable. Can be connected to the battery indefinitely, will not over-charge. Weighs 2 pounds and measures 4" W x 5 1/2" D x 2 1/2" H. Finished enclosure included in kit.

Complete Kit (#150-KIT) \$59.95
Assembled & Tested (#150-ASY) \$79.95

CA Residents add 7.75% sales tax. SHIP \$7.50 (insured)
Foreign orders add 25%

www.a-aengineering.com

A&A Engineering

2521 W. La Palma #K • Anaheim, CA 92801
(714) 952-2114 • FAX: (714) 952-3280

SCSI

I-320 50Pin-68Pin-80Pin
1 to 8 Bay Case Enclosures
Adapters Cables Terminators
Low Prices - Qty Discounts!
(Also FireWire, USB, Video)
www.mcpcb.com

Computer Hardware Wanted

DEC EQUIPMENT WANTED!!!

Digital Equipment Corp.
and compatibles.
Buy - Sell - Trade

CALL KEYWAYS 937-847-2300
or email buyer@keyways.com

Design/Engineering Services

ONE PAS, INC.

The
Future
of
Prototyping

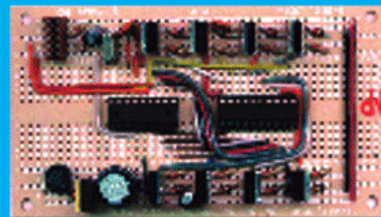

www.onepasinc.com

Microcontrollers

MicroStamp11

World's Smallest 68HC11
Microcontroller Module!



- telemetry
- microbots
- smart toys
- animatronics
- model railroading
- home automation

- tiny (1 by 1.4 in.), light-weight (0.5 oz.)
- on-board 5V reg., crystal, & reset chip
- choice of 8K or 32K EEPROM
- or 32K RAM + 32K EEPROM (64K version)
- SCI, SPI, Output Compare and Input Capture channels, timer, pulse accumulator
- all 14 I/O lines and 2 interrupt lines brought out to versatile 20-pin connector
- program in BASIC, assembler, or C
- easy code-loading with Docking Module
- Starter Packages:*

- 8K EEPROM (#MS11SP8K).....\$49
- 32K EEPROM (#MS11SP32K)....\$77
- 32K EE/32K RAM (MS11SP64K)\$90

* includes MicroStamp11, manual, PC software (assemblers, SBASIC compiler, MicroLoad utility, and sample programs), serial cable, Docking Module, & accessories.

www.technologicalarts.com

Toll-free (USA & Canada):
1-877-963-8996

Visa • MasterCard • Discover • Amex

Amateur Radio

WWW.4ATV.COM



\$129/ea

2.4 GHz Power Amplifier,
Power Supply included,
10-40 mW Input, 1 W Output,
Size: Approx 2" X 2" X 3/4"

(847) 303-9700 info@4atv.com

Satellite

4DTV • C-band • Ku-band MPEG-2 • DISH • DIRECTV

We carry a full line of systems,
upgrades, replacement parts, more!
Get it all with just one call!

800-500-9275

FREE Satellite TV Buyer's Guide

Skyvision

www.skyvision.com

*Circuit board layouts
*Prototype assemblies
WWW.OSPREYELECTRONICS.COM
Convert your sketch or print into a quality
pcb for a reasonable price. Visit us on
the web or call Osprey Electronics at
(208) 664 1089 (USA)

Vacuum Tubes

WANTED

To buy COMPLETE vacuum tube
collections, ANY quantity. Will buy
new, new w/o boxes, and used. We buy
all types and will not cherry pick your
collection. Will travel to inspect and
pick up large hoards.
Paul, Sound Ideas, 3215 NW 13th
Street, Gainesville, FL 32609.

pwb@soundideastereo.com

*please list tubes in the note line
of your email

352-378-0192

FAX #1 352-371-1791

FAX #2 352-336-6821

(10 am-7 pm EST M-F; 10 am-5 pm Sat)

Education

UNISTEP

We are building what you wish you had in the lab!

**ELECTRONICS LAB
MODULES & KITS**
FOR
**COLLEGE & UNIVERSITY
INSTRUCTORS**

Unistep Technologies

Concepts ...

- Data Communication
- Internet Protocols
- OSI Model & DLC
- Computer Interfacing
- Automatic Control
- Telecom Circuits

AND MORE ...

Some of our products ...

- Synchronous Frame Generator
- PLL & Freq. Synthesis Modules
- USB, Ethernet, Ser. & Par. I/O
- Full-Duplex IR Modem Module
- USB & Serial Data Acquisition
- Telephone Switch Clusters

Web: www.unistep.ca E-Mail: info@unistep.ca

CLASSIFIEDS

Miscellaneous Electronics For Sale

OVER 4,300 ITEMS IN STOCK
Surplus & Refurbished
Electronic Equipment
Parts & Accessories

Audio, Communication, Computer, Telephone, &
Video Equipment. Repair Parts & Service Manuals.



SMC ELECTRONICS
www.smcelectronics.com

On Sale Now

Cordless Telephone Battery Packs
50 - 75% OFF RETAIL PRICES!

Join our

ONLINE

electronics forums!

www.nutsvolts.com

Poor AM Radio Reception?
This is the Solution!
Select-A-Tenna



For more than 34 years, this technically elegant but, simple-to-use device has significantly improved weak AM radio reception. The signal gain is as great as thirty times! And, no hook-up to your radio is required. Simply place it next to your radio and tune. It is already working! No batteries, no wires. It is powerful and really works. You'll be amazed!

Model 541
\$59.95 plus
shipping
Satisfaction Guaranteed

Other models are
available, see the
complete story
at our web-site

Intensitronics Corp
PO Box 28
Ashland, WI 54806
800-382-4155 Toll-Free
715-685-0474 Fax
www.selectatenna.com
Made in the USA

Plans/Kits/ Schematics

Five Volt DC 100mA Kit

- Measures 1-3/4 x 1-5/8
- Kit contains bridge rectifier, all filter caps, and LM78L05 regulator.
- \$9.95 ea. postpaid.

G. JOSEPH FINN, JR.
244 Mistwood Ln., N. Aurora, IL 60542
gjfdaraRCDD@aol.com

CELLULAR JAMMERS

Cellular Jammers and
other unique plans and
electronic kits

www.kenneke.com

Call us TODAY to start your
subscription to SERVO Magazine!

800-783-4624

Publications

Stepper Motor Book

Easy Step'n

Table Of Contents
Ordering Info
On Web Site

<http://www.stepperstuff.com>

SQUARE 1

ELECTRONICS
(208) 664-4115
Hayden, ID USA

Subscribe today!
www.nutsvolts.com

News Bytes

Mars Rover Breaks Records

On three consecutive days, NASA's Mars Exploration Rover, Opportunity, accomplished unprecedented feats of Martian motion, covering more total ground in that period than either Opportunity or its twin, Spirit, did in their first 70 days on Mars.

Opportunity set a one-day distance record of 177.5 meters (582 feet) on February 19. The new record exceeded a two-week-old former best by 13 percent. As on all previous long drives by either rover, the traverse began with "blind" driving, in which the rover followed a route determined in advance by the planners at JPL. That portion of the drive lasted an hour and covered most of the day's distance. Then Opportunity switched to "autonomous" driving for two and a half hours, pausing every two meters (6.6 feet) to look for obstacles.

On the third day of the three-day plan, the robotic geologist continued navigating itself and drove even farther, 109 meters (357 feet), pushing the three-day total to 390 meters (nearly a quarter of a mile). In one long weekend, Opportunity covered a distance equivalent to more than half of the 600 meters that had been part of each rover's original mission criteria during their first three months on Mars.

Opportunity has driven 3,014 meters (1.87 miles)

since the landing, while Spirit has driven even farther, 4,157 meters (2.58 miles).

Asimo Helps Protect Kids

The National Safety Council and American Honda Motor Co. launched "Step to Safety with ASIMO," a new safety video program in which Honda's humanoid robot, ASIMO, teaches young children how to safely cross the street. Thousands of these unique, child-friendly safety videos are being distributed free to educators, law enforcement officers, government officials, and child safety advocates across the nation to raise awareness of pedestrian safety and to help prevent pedestrian injuries and fatalities among children.

According to the National Highway Traffic Safety Administration, 22 percent of children between the ages of five and nine who were killed in traffic crashes in 2003 were pedestrians.

"Step to Safety with ASIMO" teaches safe and responsible street crossing procedures to young children ages five to nine. In the 14-minute video, ASIMO interacts with children, using its human-like mobility to demonstrate how to stop at curbs, look in every direction, and cross streets at intersections. For more information, visit www.honda.com

Tech Forum

QUESTIONS

I am using a variac to control the voltage going to a filament for heating purposes. Does anyone know of a way to control the AC current going to this filament in an electronic fashion?

#04051

Paul Komarenko
Via Internet

In the winter time of northern climates, it is a great advantage to know if your car's 120 volt block heater is actually working. Presently, extension cords can be purchased that have a lighted end that show the presence of voltage. However, I am looking for a simple circuit to build into the male AC plug of the block heater,

or in-line with the cord, that would detect current flow (typically about four amps AC). Preferably the indicator would be an LED or neon bulb.

#04052

Ron Sharpe
Regina, SK Canada

I thought I recently saw a 'how-to' article on how to build a home made 'chip' that increases the power in a Cummins diesel, pick-up engine. It modifies the fuel and timing curves. Any ideas?

#04053

Larry
Via Internet

I have a pair of RF modules salvaged from a 900 MHz cordless phone and the corresponding base.

One of them is marked "BRF-140-0601 RF Module" and both have headers with pins marked "T+", "ST", "AI", "GN", "SQ", "DI", "AO", "R+", and "CL". I've come up with several good guesses as to the meaning of the pins, but I'm hoping someone can give me definitive answers.

Does anyone know who makes this, or where I can find the data sheet? Would these modules work as two-way radio modems?

#04054

Jeff Bowles
Powell OH

ANSWERS

[#1051 - January 2005]

I installed a homemade electronic rear-view mirror in my RV. I already had a 5" monitor and connected it to a \$39.00 CMOS black-and-white camera. It works fine, but the image is opposite from a mirror view when viewed on the monitor.

Anonymous
Via Internet

The solution to your problem is as simple as reversing two wires inside your monitor. The horizontal yoke windings are what you need to locate and transpose. The yoke will have four wires, with continuity showing between each of two individual pairs. One is the vertical deflection coil, the other horizontal. The correct pair can be found by trial and error. When the leads for the vertical coils are manipulated, the picture will be upside down, the horizontal coils will "mirror image" the picture. If you don't disturb the yoke's mechanical position, no other adjustments will be necessary.

If you wish to be able to simply return the monitor to normal operation without having to change the wiring again, a simple switching arrangement constructed with a DPDT switch can be mounted on the unit to facilitate this.

A caution if you go this route though, don't switch while power is applied to the monitor, or you risk

This is a READER-TO-READER Column. All questions AND answers will be provided by *Nuts & Volts* readers and are intended to promote the exchange of ideas and provide assistance for solving problems of a technical nature. All questions submitted are subject to editing and will be published on a space available basis if deemed suitable to the publisher. All answers are submitted by readers and NO GUARANTEES WHATSOEVER are made by the publisher. The implementation of any answer printed in this column may require varying degrees of technical experience and should only be attempted by qualified individuals. Always use common sense and good judgement!

Send all material to *Nuts & Volts Magazine*, 430 Princland Court, Corona, CA 92879, OR fax to (951) 371-3052, OR email to forum@nutsvolts.com

ANSWER INFO

- Include the question number that appears directly below the question you are responding to.
- Payment of \$25.00 will be sent if your answer is printed. Be sure to include your mailing address if responding by email or we can not send payment.
- Your name, city, and state, will be printed in the magazine, unless you notify us otherwise. If you want your email address printed also,

indicate to that effect.

- Comments regarding answers printed in this column may be printed in the Reader Feedback section if space allows.

QUESTION INFO

To be considered

All questions should relate to one or more of the following:

- 1) Circuit Design
- 2) Electronic Theory
- 3) Problem Solving
- 4) Other Similar Topics

Information/Restrictions

- No questions will be accepted that offer equipment for sale or equipment wanted to buy.
- Selected questions will be printed one time on a space available basis.
- Questions may be subject to editing.

Helpful Hints

- Be brief but include all pertinent information. If no one knows what you're asking, you won't get any response (and we probably won't print it either).
- Write legibly (or type). If we can't read it, we'll throw it away.
- Include your Name, Address, Phone Number, and Email. Only your name, city, and state will be published with the question, but we may need to contact you.

damaging the deflection circuits.

Jason Neill
Jersey City, NJ

[#1053 - January 2005]

I have acquired an HP 7580B plotter that is mechanically sound. When I turn it on, E02 is displayed after a self-test. The operator manual says it's a microprocessor error/ROM checksum error. When I plot a drawing, it plots to one side and only half of the drawing is on the page.

Alex Malachowski
Via Internet

#1 Since the plotter is functioning, it seems likely that the E02 is from the EEPROM that is used to calibrate the unit, although I don't have the manuals to check that. EEPROM technology was quite new when the 7586B was designed, the part used was quite unreliable, and the part is probably unobtainable. If the part were replaced, the 7586B can be calibrated, but the process is tedious.

This means that the unit can be used to make drawings, where high accuracy is not a concern, but is probably not useful for PCB layouts or mask making.

The offset plotting is probably an HPGL compatibility issue. The HPGL language was revised after the 7586 was made, becoming HPGL/2, and most newer drivers are made for plotting to HPGL/2 devices. If you can capture and edit the plot file, it should be possible to center the plot by changing a few of the HPGL commands in the header, such as scaling (SC), input corners (IP), and input window (IW). The default coordinate system of the 7586 had the origin in the center of the page, with plotter units of .025 mm, where the pen moves in the Y axis and the paper moves in the X axis.

Charles Keith
Poway, CA

#2 Congratulations on getting as far along with troubleshooting your plotter as you have. You say that you

have a ROM error. I saw a similar case back in the early 80s at a large aerospace company. An experienced microcomputer technician returned an old microcomputer to service by removing the EPROMs, reading them into a programmer, and burning a new set for reinstallation.

Why would this work? The EPROMs had deteriorated to the extent that at least one bit in one word could not be read at the normal execution speed of the microprocessor. However, the EPROMs could still be read by the slower process used by the programmer to read in a good copy. Once a new copy was made in new devices, the code could be read and executed at the normal speed of the microprocessor.

Open the plotter to determine what type of EPROMs you have. Look for some 24-pin, 0.6-inch-wide socketed devices with stick-on labels affixed to the quartz windows. Expect to find two to four EPROMs. Look for part numbers such as 2716, 2732. The Jameco catalog still lists devices as old as 2708, though I have not seen any that old in a plotter. Any dash numbers after your part number indicate the speed grade. Buy replacement devices of the same speed or faster, that is, a smaller dash number.

You will need access to an EPROM programmer, or someone who has access. The device that you propose to program needs to be on the list of programmable devices for that programmer. Per instructions for the programmer, read in an original device and program a new device. Repeat this for all EPROMs. Install the new set of EPROMs in the plotter. Good luck as you power up the plotter.

Dennis Crunkilton
Abilene, TX

[#1052 - January 2005]

I am looking for a simple on/off switch that can be triggered by electrodes placed on the skin. It needs to have a sensitivity

adjustment. I would also like to have it opto-isolated for safety. Any suggestions or places I can look?

Chris Tauscher
Via Internet

Take a look at the following books that contain all the information needed:

*Introduction to Biomedical
Equipment Technology*

Joseph Carr, John M. Brown
Prentice Hall

ISBN: 0138494312

This is a textbook aimed towards the design and repair of medical equipment, but covers all the basics. A very good quality of this book is that it contains lots of practical information and circuits.

The author, Joseph Carr, had a prolific life of writing and researching a lot of topics related to electronics.

Another good book, maybe a bit more theoretical is:

Medical Instrumentation

John G. Webster

Houghton Mifflin Company

These books should be available in the local library or that of a nearby community college or university.

Albert Lozano
Edwardsville, PA

[#2051 -February 2005]

I'm trying to find service information or help for a BSR MCD8090 AM/FM Stereo Receiver. This unit was called a "Thunder Thrower" and was purchased from DAK Industries. The FM section is not working.

Mike Uschak
Loyalhanna, PA

Most stereo receivers are laid out in a very logical manner. You can usually trace the signal path from input to output.

Start at the FM antenna terminals and trace the wiring back through the front-end (probably a sealed module on this receiver) and through the IF stages. The IF stages may only be a single chip. A little careful probing along the signal path with an

oscilloscope will point you to where the signal dies. You won't see anything at the antenna terminals, but you should get a signal large enough to see on the scope coming out of the front end.

There's an address for BSR listed on forums.djcafe.com which is BSR, Suite 200, 18369 Eddy Street, Northridge, CA 91325; (213) 689-9188.

You can try calling them or writing to them. I would imagine that the area code is probably something other than 213 now (818 maybe?)

DAK does sell "closeouts," so BSR may be out of business.

Don Parrish-Bell
San Diego, CA

[#2053 -February 2005]

I'm working on an old Epiphone Electar Zephyr guitar amp. It looks like it's from the 30s or 40s.

I got the amp working, but I can not get the vibrato to work. The oscillator is very weak.

I cannot find a schematic for it. Does anyone have one or know how it is wired? The output of the oscillator goes to the grids of the two 6V6s.

Jon Garee
Newark, OH

#1 As far as I can tell by searching the Internet, the Electar Zephyr amp did not have a stock vibrato circuit, but had space in the back and was apparently a common modification, since this is not the first time I saw mention of it. Now, when you say that the oscillator is very weak, do you mean that it does not oscillate at a proper speed, or that the effect simply does not work well?

In the first case, there are a couple of possible solutions. If it was, in fact, an after-market component, it is possible that it never worked well in the first place. In this case, I would advise replacing the oscillator section with a modern, solidstate oscillator. This shouldn't affect the sound of the vibrato at all.

APRIL 2005

The second likely problem is a bad capacitor in the oscillator section that is supposed to control timing. If it is the second case, that the whole effect isn't working, I'm not sure I know what to tell you. There's a possibility that there is a bias problem, if the oscillator feeds directly to the tubes on the amp. I think I should point you in the direction of Ampage, an

excellent online forum when it comes to tube amps. It is located here www.firebottle.com/fireforum/fireBB.cgi?cfg=ga&enter=go

Hal Emmer
Setauket, NY

#2 Weak or no vibrato (actually it is a tremolo) in tube guitar amps is common. You don't say what tubes

**NanoCore12™ for best performance and price!
9S12C microcontroller modules starting at \$45!**



NanoCore12™ Features:

- on-board RS232C interface
- up to 33 I/O lines, with multi-property programmability (e.g. direction, pull-up/pull-down, reduced drive, invert polarity, etc.)
- up to 8 key wake-up interrupt inputs, with digital filtering
- SCI • SPI • CAN
- 8-channel 10-bit ADCs
- multiple PWM channels
- 4-channel timers, supporting input capture/output compare, event counting, gated time accumulation, and simple PWM
- 32K multi-sector Flash • 2K RAM
- operates up to 48MHz via PLL
- 3.3 V or 5 V operation
- advanced CISC architecture
- on-chip Serial Monitor
- supports BDM debugging

Conveniently pin-compatible with BASIC Stamp2® OEM (1K): from \$23 Single: from \$45

www.technologicalarts.com
Toll-free: 1-877-963-8996
(USA & Canada)

™NanoCore12 is a trademark of Technological Arts, Inc.
© BASIC Stamp is a registered trademark of Parallax, Inc.

HOBBY ENGINEERING

The technology builder's source for kits, components, supplies, tools, books and education.

Robot Kits For All Skill Levels



Books and Educational K

BEAM Kits and Components

ICs, Transistors, Project Kits

Motors, Frame Components and Scratch Builder Supplies.

Order by Internet, phone, fax or mail.
www.HobbyEngineering.com
1-866-ROBOT-50
 1-866-762-6850
 1-650-552-9925
 1-650-259-9590 (fax)
sales@HobbyEngineering.com
 180 El Camino Real
 Millbrae, CA 94030
Visit our store near SFO!

Most orders ship the day received! World-wide shipping. Convenient payment options.

are used in the vibrato circuit. The *Tube Amp Book* by Aspen Pittman (published by Groove Tubes LLC, 2002) is a good source of schematics for tube amps, but it has only three Epiphone schematics, none of them use 6V6 output tubes. There are 450 amp schematics in the book, you probably could find one with a vibrato circuit which is similar to the Epiphone. The book can be purchased from several electronic music sources, including Antique Electronics Supply (www.tubesandmore.com). They also have several other books on tube guitar amps; *A Desktop Reverence of Hip Vintage Guitar Amps* by Gerald Weber also contains schematics.

Bill Stiles
Hillsboro, MO

[#2054 -February 2005]

I need to purchase a good, reliable, and low-cost schematic capture/board layout program. Suggestions?

Aldo Powell
Via Internet

#1 I have used Eagle™ by CadSoft very successfully (www.cadsoft.de/). The demo version is free and fully functional, although it's restricted to two layers and Eurocard size. This can give the user a good feel about its

functionality and mode of operation. A plus is that the website contains a tutorial on the use of the software. Moreover, the book *Build Your Own Printed Circuit Board* by Al Williams (McGraw Hill; ISBN: 007142783X) contains a very detailed step-by-step procedure for this software.

The software, tutorial and manual can be downloaded at www.cadsoft.de/cgi-bin/download.pl?page=/home/cadsoft/html_public/download.htm.en&dir=pub/program/4.1

The complete version can also be purchased from the previous websites at what I consider to be a very reasonable and competitive price.

Albert Lozano
Edwardsville, PA

#2 How does free sound?

Go to ExpressPCB or PCB123's site and download their software.

Don Parrish-Bell
San Diego, CA

[#2052 -February 2005]

I recently purchased a 48 VDC to 12 VDC switching power supply from a surplus place. What are the general rules of thumb for getting this thing to work?

I know switchers need a load, but on which output? It has +3 V, +5 V, -12 V, and +12 V outputs. I am only interested in the +12 @10 A output. This supply has a couple of sensing circuits; what do they usually tie to?

Bob Sheetz
Ocala, FL

The input power required will be that used by the load(s) connected to the output line(s) plus losses (heat) within the power supply. Make sure your power source (48 volts DC in your case) is suitable (can deliver required power).

Not all switching power supplies require a minimum load, although some do. If the power supply seems unstable or output is not in specification, add a fixed resistor (or suitable light bulb) to each output. Use Ohm's Law $V=IR$ to figure, say, 200 mA load on each output. Increase current only if needed and do decrease if possible.

The sensing circuits must tie to their respective output voltage lines. They are used for what is called "remote voltage sensing." For many applications where the load is physically close to the power supply, the + and - sense lines are tied right back to the power supply terminal's + and - output lines of their respective voltage. If the voltage drop between the power supply and load is noticeable and causes a problem (possible with 10 amps at 12 volts), the sensing lines are connected at the load (not power supply terminals) + and - and the voltage drop across the load lines will be compensated, i.e., reduced to zero.

Erik von Seggern

NEW ZigBee™ Modules
XBee™ & XBee Pro™

(Actual Size) (Actual Size)

MaxStream XBee™ MaxStream XBee PRO™

Interchangeable 33mm 25mm

Lowest Cost Highest Performance

- Fast To Market
- Easy To Use
- Free Support
- FCC/CE Ready

Front View Back View Side View

MaxStream
Toll Free: (866) 765-9885
www.maxstream.net

Call and order your development kit today!

Abacom Technologies53	Computer Circulation Center71	Information Unlimited64	Micromint87	Ramsey Electronics, Inc.14-15
ActiveWire, Inc.61	Conitec DataSystems43	Integrated Ideas & Technologies, Inc.22	Mouser Electronics53	Resources Un-Ltd.7
Advanced Microcomputer Systems73	Cook's Institute73	Intronics, Inc.60	Multilabs61	Robotic Trends83
All Electronics Corp.67	Cunard Associates60	Jameco45, 70	Net Media2	Scott Edwards Electronics, Inc.47
AREXX Engineering75	DDS, Inc./BSIO61	Jaycar Electronics37	Northwest Technical, Inc.61	Surplus Sales of Nebraska29
Atlantic Int'l Institute, Inc.82	Deys Electronics27	LabJack55	Parallax, Inc.Back Cover	Technological Arts95
Atomic Time85	Earth Computer Technologies86	Lemos International Co., Inc.17	PCB123/PCBexpress5	Tetsujin 200568
AWC75	Electronic Design Specialists52	Linx Technologies9	Pico Technology Ltd. UK49	Trace Systems, Inc.36
Bellin Dynamic Systems, Inc.61	EMAC, Inc.48	Lynxmotion, Inc.89	PolarisUSA Video, Inc.13	Trilogy Design86
Budget Robotics55	ExpressPCB19	Madell Technology Corp.79	Pulsar, Inc.61	Windsor Distributors58
C & S Sales, Inc.77	Front Panel Express LLC25	Matco, Inc.61	QKITS61	XGameStation61
Circuit Specialists, Inc.98-99	Halted Specialties Co.3	Maxstream96	R4Systems, Inc.11	Zagros Robotics61
Command Productions21	Hobby Engineering95	microEngineering Labs81	RABBIT Semiconductor23, 39, 61	

AMATEUR RADIO & TV

Atomic Time85	PolarisUSA Video, Inc.13
Ramsey Electronics, Inc.14-15	Surplus Sales of Nebraska29
Windsor Distributors58	

BATTERIES/CHARGERS

Cunard Associates60

BUSINESS OPPORTUNITIES

AREXX Engineering75

BUYING ELECTRONIC SURPLUS

Earth Computer Technologies86	Jaycar Electronics37
-------------------------------------	----------------------------

CCD CAMERAS/VIDEO

Circuit Specialists, Inc.98-99	Matco, Inc.61
PolarisUSA Video, Inc.13	Ramsey Electronics, Inc.14-15

CIRCUIT BOARDS

Advanced Microcomputer Systems, Inc.73	Cunard Associates60
Deys Electronics27	ExpressPCB19
Maxstream96	Micromint87
Northwest Technical, Inc.61	PCB123/PCBexpress5
Pulsar, Inc.61	R4Systems, Inc.11

COMPONENTS

Bellin Dynamic Systems, Inc.61	Front Panel Express LLC25
Jameco45, 70	Lemos International Co., Inc.17
Linx Technologies9	Maxstream96
Micromint87	PCB123/PCBexpress5
Pulsar, Inc.61	Windsor Distributors58

COMPUTER

Hardware	
ActiveWire, Inc.61	Earth Computer Technologies86
Halted Specialties Co.3	Surplus Sales of Nebraska29

Microcontrollers / I/O Boards

Abacom Technologies53	AWC75
Conitec DataSystems43	DDS, Inc./BSIO61
EMAC, Inc.48	microEngineering Labs81
Micromint87	

Multilabs61	Net Media2
Parallax, Inc.Back Cover	R4Systems, Inc.11
Scott Edwards Electronics, Inc.47	Technological Arts95
Trace Systems, Inc.36	XGameStation61

Software

Advanced Microcomputer Systems, Inc.73	Deys Electronics27
Trilogy Design86	

DESIGN/ENGINEERING/REPAIR SERVICES

DDS, Inc./BSIO61	ExpressPCB19
Front Panel Express LLC25	Pulsar, Inc.61
R4Systems, Inc.11	Trace Systems, Inc.36

EDUCATION

Atlantic Int'l Institute, Inc.82	Command Productions21
Cook's Institute73	EMAC, Inc.48
Hobby Engineering95	XGameStation61

ENCLOSURES

Integrated Ideas & Technologies, Inc.22
--

EVENTS

Robotic Trends83	Tetsujin 200568
------------------------	-----------------------

KITS

AREXX Engineering75	C & S Sales, Inc.77
Earth Computer Technologies86	EMAC, Inc.48
Hobby Engineering95	Information Unlimited64
Jaycar Electronics37	Northwest Technical, Inc.61
QKITS61	RABBIT Semiconductor23, 39, 61
Ramsey Electronics, Inc.14-15	Scott Edwards Electronics, Inc.47
XGameStation61	

LASERS

Information Unlimited64

MISC./SURPLUS

All Electronics Corp.67	Computer Circulation Center71
Front Panel Express LLC25	Halted Specialties Co.3
Resources Un-Ltd.7	Surplus Sales of Nebraska29
Windsor Distributors58	

MOTORS

Computer Circulation Center71	Jameco45, 70
-------------------------------------	--------------------

PUBLICATIONS

Mouser Electronics53

PROGRAMMERS

Conitec DataSystems43	Intronics, Inc.60
microEngineering Labs81	

RF TRANSMITTERS/RECEIVERS

Abacom Technologies53	Linx Technologies9
Matco, Inc.61	

ROBOTICS

Budget Robotics55	Hobby Engineering95
Jameco45, 70	LabJack55
Lemos International Co., Inc.17	Lynxmotion, Inc.89
Net Media2	Zagros Robotics61

SATELLITE

Lemos International Co., Inc.17

SECURITY

Computer Circulation Center71	Information Unlimited64
Linx Technologies9	Matco, Inc.61
PolarisUSA Video, Inc.13	

TEST EQUIPMENT

Bellin Dynamic Systems, Inc.61	C & S Sales, Inc.77
Circuit Specialists, Inc.98-99	Conitec DataSystems43
Electronic Design Specialists52	Intronics, Inc.60
Jaycar Electronics37	LabJack55
Madell Technology Corp.79	Pico Technology Ltd. UK49
Trace Systems, Inc.36	

TOOLS

C & S Sales, Inc.77	Madell Technology Corp.79
--------------------------	--------------------------------

VIDEO

Multilabs61

WIRE/CABLE & CONNECTORS

Jameco45, 70

Digital Storage Oscilloscope Module



PC based Digital Storage Oscilloscope, 200MHz 5GS/s equiv. sampling USB interface

Convert any PC with USB interface to a high performance Digital Storage Oscilloscope. This is a sophisticated PC basedscope adaptor providing performance compatible to mid/high level stand alone products costing much more! Comes with two probes.

Details & Software Download at Web Site

> Test Equipment > Oscilloscopes/Outstanding Prices

Item# 200DSO Only \$859.00

Digital Anemometer

Item# CSIMS6250

Only \$89.00!

A portable Digital Anemometer that will measure wind speed. Simply hold it in your hand or attach it to something stationary with the attached Hang Ring or Tripod Connector. The large LCD display and backlight make for easy readings.

Details at Web Site

> Test Equipment > Specialty Test Equipment



NEW!

Digital Sound Level Meter

A Digital Sound Meter with RS-232 port ideally suited for testing sound levels to OSHA's requirements, detect noise, music levels or sound engineering applications.

\$129.00!

Item# CSIMS6701

Details at Web Site > Test Equipment > Specialty Test Equipment



NEW!

Triple Output Bench Power Supply

with Large LCD Displays



Output: 0-30VDC x 2 @ 3 AMPS & 1ea. fixed output @ 5VDC@3A
Source Effect: $5 \times 10^{-4} = 2mV$
Load Effect: $5 \times 10^{-4} = 2mV$
Ripple Coefficient: <250uV
Stepped Current: 30mA +/- 1mA
Input Voltage: 110VAC

CSI3003X3/\$179.00 (qty 5+/\$169.00)

Details at Web Site

> Test Equipment > Power Supplies

www.CircuitSpecialists.com

Circuit Specialists Soldering Station w/Ceramic Element & Separate Solder Stand

\$34.95!

- Ceramic heating element for more accurate temp control
- Temp control knob in F(392° to 896°) & C(200° to 489°)
- 3-prong grounded power cord/static safe tip
- Separate heavy duty iron stand
- Replaceable iron/easy disconnect
- Extra tips etc. shown at web site



Item# CSI-STATION1 Rapid Heat Up!

In Business



Since 1971



Item# CSI825A++

MicroProcessor Controlled!

Includes 4 Nozzles!

FANTASTIC VALUE!!

Only \$199.00!

SMD RE-WORK SYSTEM w/Vacuum Pick-up tool

Details at Web Site

> Soldering Equipment & Supplies > Rework Stations



Also Available w/Digital Display & MicroProcessor Controller



Item# CSI-STATION2

\$49.95

Details at Web Site

> Soldering Equipment & Supplies > Soldering Stations

SMD Hot Tweezer Adaptor Fits CSI Stations 1 & 2, and also CSI906

\$29.00

Item# CSITWZ-STATION



Humidity/Temperature Meter w/RS-232

Item# CSIMS6503

Only \$149.00!

A portable high quality Humidity Temperature Meter with a large LCD display and backlight that makes it very easy to read. The RS-232 port and included software allow you to keep the unit hooked up to your computer for extended measurement taking and for storage, analysis and printing of data.

Details at Web Site

> Test Equipment > Specialty Test Equipment



NEW!

PC Based Scope Card

Item# MODEL 220

- 32K samples/Channel memory
- Includes software and a CD ROM
- 20Ms/S Sampling rate/Channel
- Scroll mode has sweep times to 1Hr/Sec
- Voltage and Time Cursors
- Voltage Range: 50mV to 5V, 7 Steps
- Time Range: 50ns/div to 0.5s/div, 1-2-5 22steps

See Details on Web Site

A \$189.00 Value!

Only \$109.00!

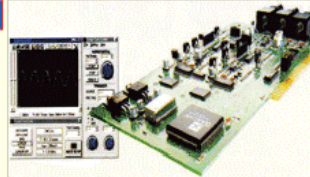

Technical Details at Web Site > Test Equipment > Oscilloscopes/Outstanding Prices

Digital/Analog High Voltage Insulation Tester

A measuring instrument which can be used in the testing of high voltage insulation for the maintenance and service of industry equipment, such as cables, transformers, generators, switches, etc. The meter has an auto range from 0 to 100,000Mohm indicated by a dual scale point needle which will auto-change the high or low range according to the value of the resistance.

Details at Web Site Only \$179.00

> Test Equipment > Specialty Test Equipment



NEW!

Protek 100MHz Realtime Scope

2 Ch Dual Trace
6" Internal Grid
ALTMAG
ALTRIG
TV Sync
5 Vertical Modes



Item# 6510

Details at Web Site > Test Equipment > Oscilloscopes/Outstanding Prices

Brand New Not Refurbished! Includes 2 scope probes

A \$975.00 Value!

100MHz only \$499.00

While Supplies Last!

Super Blowout Price!

A Complete Electronics Lab

You supply the PC to complete a powerful test system which includes a two channel Digital Storage Oscilloscope, a 16 channel Logic Analyzer, an Arbitrary Waveform Generator, two Programmable Power Supplies and two Programmable Clock Generators.

Details at Web Site Item# ELAB-080

> Test Equipment > Oscilloscopes/Outstanding Prices



\$495.00

Dual Output DC Bench Power Supplies

High stability digital read-out bench power supplies featuring constant voltage and current outputs. Short-circuit and current limiting protection is provided. SMT PC boards and a built-in cooling fan help ensure reliable performance and long life.

As Low As \$93.00!

- Source Effect: $5 \times 10^{-4} = 2mV$
- Load Effect: $5 \times 10^{-4} = 2mV$
- Ripple Coefficient: <250uV
- Stepped Current: 30mA +/- 1mA

HOT ITEM!

Both Models have a 1A/5VDC Fixed Output on the rear panel

CSI3003X-5: 0-30v/0-3amp/1-4..\$97.00/5+..\$93.00

CSI5003X-5: 0-50v/0-3amp/1-4..\$107.00/5+..\$103.00

Details at Web Site > Test Equipment > Power Supplies



3M™ DataCom Cable Tester

UNBEATABLE PRICE



This unit allows for mapping, testing and troubleshooting of various lines, including installed data communications, phone wiring and coaxial cable runs. Performs multiple test on the following cable types, up to 1000 feet in length: Unshielded telephone cables with RJ-11 and RJ-45 connectors; Ethernet 10 (100) Base-T; Token Ring; EIA/TIA-568 A/B; AT&T 258a; USOC; 50 or 75 ohm Coax with F or BNC connectors.

Only \$49.00

Originally Sold for \$200.00!

Item# **DT-2000**

Details at Web Site Includes: Hobster, Case, 7 Remotes & Telecom Alligator Clips
 > Test Equipment > Specialty Test Equipment

RF Field Strength Analyzer

Compare at Over \$2000!

The **3201** is a high quality hand-held RF Field Strength Analyzer with wide band reception ranging from 100kHz to 2060MHz. The 3201 is a compact & lightweight portable analyzer & is a must for RF Technicians. Ideal for testing, installing & maintenance of Mobile Telephone Comm systems, Cellular Phones, Cordless phones, paging systems, cable & Satellite TV as well as antenna installations. May also be used to locate hidden cameras using RF transmissions



Item# **3201**

New Fantastic Low Price: \$1299.00!

- WFM/NFM/AM/SSB modulated signals may be measured.
- Signal Levels up to 160Channels can be displayed simultaneously on the LCD
- PLL tuning system for precise frequency measurement and tuning
- Built-in Frequency Counter
- LED Backlight LCD (192x192 dots)
- All functions are menu selected.
- RS232C with software for PC & printer interface
- Built-in speaker **(Includes Antenna)**

Limited Time Offer

Details at Web Site > Test Equipment > RF Test Equipment

53,000 Count High Accuracy Bench Model DMM

This bench DMM has high accuracy and high stability. It contains a 24 bit A/D converter and being controlled by a single-chip computer, it can operate for several ten measurement functions. It's five digits can count up to 53000. Not only DC, AC RMS, but DC and AC mixture signals. RMS can be measured for 1000V or 10A. It has a memory function up to 30 full screens for saving test data.

Only \$279.00

Item# **CSIMS8050**



NEW!

Details at Web Site > Test Equipment > Digital Multimeters

50,000 Count High Accuracy DMM

The 50,000 count resolution provides some of the most accurate readings available in a handheld meter. Readings are easily seen on the large LCD display with backlight, but also included is an analog bargraph to provide a graphic of the critical information being displayed. True RMS readings also enhance the accuracy of this meter. An RS-232 port and software give you the ability to download all your data to a computer for storage and analysis.



NEW!

Only \$189.00

Item# **CSIMS8218**

Details at Web Site > Test Equipment > Digital Multimeters

LogicPort Logic Analyzer

The LogicPort provides 34 sampled channels including two state-mode clock inputs. It connects to your PC's USB port for ultimate convenience and performance.

\$369.00!

- 34 Channels
- 500MHz Timing mode sample rate
- 200MHz State mode sample rate
- Real-time Sample Compression
- Multi-level trigger
- +6V to -6V Adjustable Threshold



NEW!

Item# **LOGICPORT**

Details at Web Site > Test Equipment > Logic Analyzers

SONY Super HAD CCD™ equipped camera's feature dramatically improved light sensitivity

SONY Super HAD CCD Color Weatherproof IR Cameras

- Day & Night Auto Switch
- Signal System: NTSC
- Image Sensor: 1/3" SONY Super HAD CCD
- Effective Pixels: 510 x 492
- Horizontal Resolution: 480TV lines
- Built-in Lens: 6mm/F1.5
- S/N Ratio: > 48dB
- Min. Illumination: 0Lux



480 TV Lines Resolution

Item# **VC-827D**

1-4: **\$149.00** 5+: **\$139.00**

Details at Web Site > Miniature Cameras(Board,Bullet,Mini's, B/W, Color)

SONY Super HAD CCD Color Weatherproof IR Camera

- Day & Night Auto Switch
- Signal System: NTSC
- Image Sensor: 1/4" SONY Super HAD CCD
- Effective Pixels: 510 x 492
- Horizontal Resolution: 420TV lines
- Built-in Lens: 4.3mm
- S/N Ratio: > 48dB (AGC OFF)
- Min. Illumination: 0Lux



1-4: **\$89.00** 5+: **\$79.00**

Item# **VC-819D**

Details at Web Site > Miniature Cameras(Board,Bullet,Mini's, B/W, Color)

NEW!

SONY Super HAD CCD B/W Weatherproof IR Camera

- Day & Night Auto Switch
- Signal System: EIA
- Image Sensor: 1/3" SONY Super HAD CCD
- Effective Pixels: 510 x 492
- Horizontal Resolution: 420TV lines
- Built-in Lens: 6mm/F1.5
- S/N Ratio: > 48dB
- Min. Illumination: 0Lux



1-4: **\$69.00** 5+: **\$65.00** Item# **VC-317D**

Details at Web Site > Miniature Cameras(Board,Bullit,Mini's)

SONY Super HAD CCD Color Camera

Item# **VC-805** 1-4: **\$69.00** 5+: **\$65.00**

- Weather Proof
- Signal System: NTSC
- Image Sensor: 1/4" SONY Super HAD CCD
- Effective Pixels: 510 x 492
- Horizontal Resolution: 420TV lines
- Lens: 3.6mm
- S/N Ratio: > 48dB
- Min. Illumination: 1Lux/F1.2



Unbelievable Price!

Details at Web Site > Miniature Cameras(Board,Bullit,Mini's)

SONY Super HAD CCD Mini B/W Board Camera

Item# **VC-103**

- Signal System: EIA
- Image Sensor: 1/3" SONY Super HAD CCD
- Effective Pixels: 510 x 492
- Horizontal Resolution: 420TV Lines
- Lens: 3.6mm/92° Angle of View
- Min. Illumination: .05Lux/F1.2



1-4: **\$33.00** 5+: **\$29.00**

Details at Web Site > Miniature Cameras

Visit our website for a complete listing of our offers. We have over 8,000 electronic items on line @ www.CircuitSpecialists.com. PC based data acquisition, industrial computers, loads of test equipment, optics, I.C.'s, transistors, diodes, resistors, potentiometers, motion control products, capacitors, miniature observation cameras, panel meters, chemicals for electronics, do it yourself printed circuit supplies for PCB fabrication, educational D.I.Y. kits, cooling fans, heat shrink, cable ties & other wire handling items, hand tools for electronics, breadboards, trainers, programmers & much much more! **Some Deals you won't believe!**

BASIC Stamp[®] Logic Analyzer

**Protocol decoder, bug hunter,
and measurement tool.**

Parallax and USBee (www.usbee.com) combined our skills to develop the new BASIC Stamp Logic Analyzer (BSLA). This low-cost tool fits between all 24-pin BASIC Stamp and Javelin Stamp modules and their programming socket, connecting directly to your PC's USB 2.0 port.

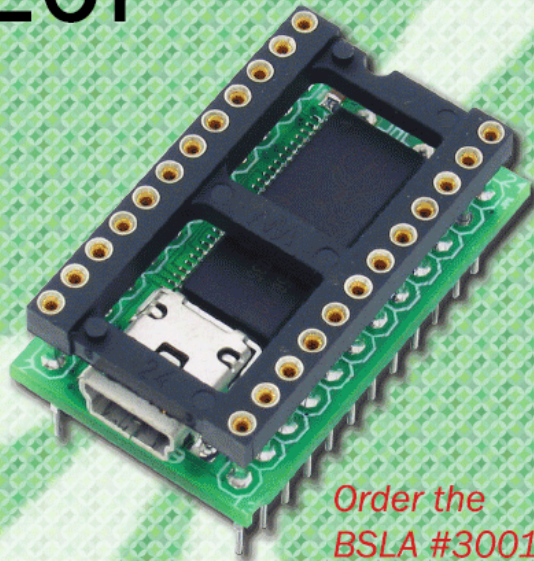

Order the
BSLA #30010
for only \$99

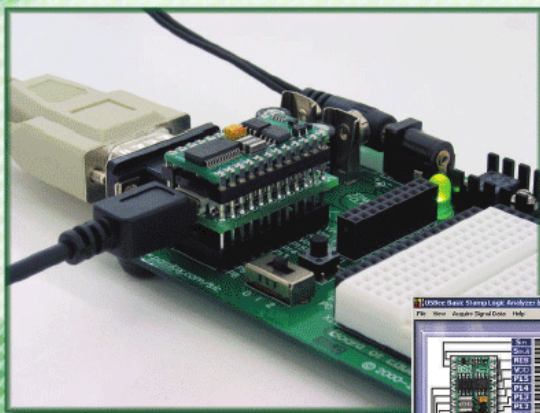

Order online at parallax.com or
call our Sales Department
toll-free at 888-512-1024
(Mon-Fri, 7 a.m. to 5 p.m., PT).

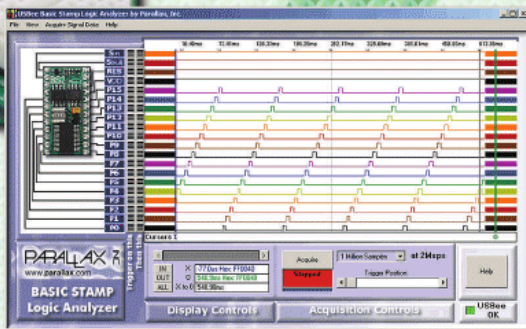

BSLA Hardware Features:

- 2 Ms/s sample rates, fast enough for all Parallax 24-pin modules
- 20 channels (16 for I/Os and 4 for Vdd, Res, Sout, Sin)
- Thresholds set at 1.4V and 0.8V, supporting TTL and CMOS
- **Free software:**
 - ❑ Compatible with Win2K, WinXP operating systems
 - ❑ Multiple triggering options on all channels
 - ❑ I²C, asynchronous serial, SPI bus decoder
 - ❑ Minimum sample depth of 1 million samples up to available PC RAM
 - ❑ Sample clock generated internally
 - ❑ Zoom in, zoom out and zoom all
 - ❑ Save, Open and Print captured data and settings
 - ❑ Movable cursors for easy measurements

PARALLAX
INC

www.parallax.com